

diciannove

porada



porada

11-14-89-91-95 libreria bookcase

aria

D. Dolcini

118 mobile bar bar cabinet

atlante bar

C. Ballabio

132 panca bench

axxia

T. Colzani

145 console console

bayus 8

G. & O. Buratti

53-56-151 coiffeuse & scatole dressing table & boxes

dafto

S. Tollgard - F. Castellani

137 credenza sideboard

drift

M. Marconato - T. Zappa

79-161 lampada table lamp

halo

D. Dolcini

115 paravento room divider

hilton

T. Colzani

164 portabiti clothes-stand

igor

D. Dolcini

70-74 tavolino side-table

jelly

C. Ballabio

108 sedia chair

lip

M. Marconato - T. Zappa

43 lampada floor lamp

lum

D. Dolcini

46 mobile bar bar cabinet

mary

P. Jouin

63 scrittoio writing desk

ninfea

N. Devetag

61-111 specchio mirror

odino

Molteni & Baron

19-106 tavolo dining table

pilar

M. Marconato - T. Zappa

33-124 tavolino coffee table

quadrifoglio

C. Ballabio

128 sedia chair

serena

E. Gallina

23-131 sedia chair

sveva

G. & O. Buratti

83 comodino, cassetiera night table, chest of drawers

tamok

G. & O. Buratti

36-40 madia cupboard

tamok

G. & O. Buratti

50-148 sedia chair

tiara

C. Ballabio

31 tavolino coffee table

tortuga

Jiun Ho

27 poltrona armchair

venus

E. Gallina

58 poltrona armchair

vera bergere

G. & O. Buratti

67-155 letto bed

ziggy bed 180**baldacchino**

C. Ballabio





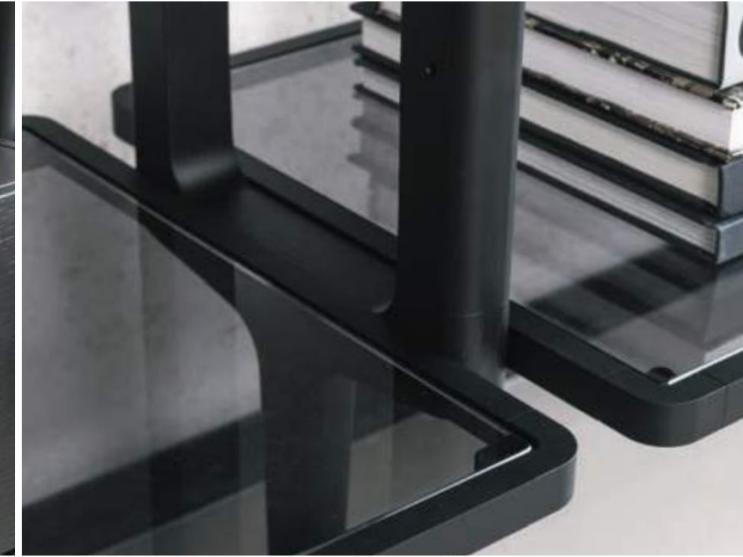

aria

aria
D. Dolcini

ARIA comp. B

Libreria modulare con colonne portanti in frassino tinto wengè e fissaggio a parete. Contenitore con cassetto da 60 cm. Mensole in cristallo fumè supportate da un telaio in alluminio nero opaco.

Modular bookcase with columns in ash wengè stained to be fixed to the wall. Container with drawer 60 cm width. Shelves in smoked glass with frame in matt black metal.



ARIA comp. H

Libreria modulare con colonne portanti in frassino tinto canapa e fissaggio a parete. Contenitore a ribalta da 150 cm con vani dotati di passacavi. Pannello porta tv laccato nero. Mensole in frassino supportate da un telaio in alluminio nero opaco.

Modular bookcase with columns in ash canapa stained to be fixed to the wall. Container with flap door 150 cm width with holes for cables management. Black lacquered board for flat TV. Shelves in ash with matt black metal frame.

aria
aria
D. Dolcini





**SVEVA**

Sedia con struttura in massello di frassino tinto wengè, schienale in Cuoietto Grigio scuro e rivestimento in tessuto Armam var. L1569/05.

Chair with frame in solid ash wengè stained, back in dark grey Cuoietto leather and cover in Armam var. L1569/05.

**PILAR MIX
RETTANGOLARE
280x120**

Tavolo da pranzo con due basi costituite da diversi elementi in massello di frassino tinto caffè e wengè e piano in cristallo trasparente fissato attraverso piastre in metallo finitura antracite spazzolato. Elementi di unione in metallo finitura cromo nero.

Dining table with two bases made up of different elements in solid ash caffè and wengè stained and top in transparent glass fixed on metal plates in brushed anthracite. Joints in black chromed metal.

pilar
pilar
M. Marconato & T. Zappa





sveva

sveva
G. & O. Buratti

SVEVA

Sedia con struttura in massello di frassino tinto wengè, schienale in Cuoietto Grigio scuro e rivestimento in tessuto Arman var. L1569/05.

Chair with frame in solid ash wengè stained, back in dark grey Cuoietto leather and cover in Arman var. L1569/05.





venus

venus
E. Gallina

JELLY H 40 OVALE

Tavolino ovale con base in metallo cromo nero e colonna centrale in massello di noce canaletta tinto wengè. Piano in vetro fuso verde con piastra in metallo.

Oval side table with black chromed base and central column in solid canaletta walnut wengè stained. Top in green cast glass with metal plate.

JELLY H 55 TONDO

Tavolino tondo con base in metallo cromo nero e colonna centrale in massello di noce canaletta tinto wengè. Piano in vetro fuso fumè con piastra in metallo.

Round side table with black chromed base and central column in canaletta walnut wengè stained. Top in smoked cast glass with metal plate.

VENUS

Poltrona con struttura in massello di frassino tinto wengè e rivestimento in Armam var. 1569/20.

Armchair with frame in solid ash wengè stained and cover in Armam var. 1569/20.





tortuga

tortuga
Jiun Ho

TORTUGA H 35 e H 41
Tavolino in noce canaletta con impiallacciatura con motivo ad intarsio incrociato, due gambe in noce canaletta e una in metallo nero opaco.

Coffee table in canaletta walnut with inlaid veneer, two legs in canaletta walnut and one in matt black metal.



quadri- foglio

quadrifoglio
C. Ballabio

HALO 60

Lampada da tavolo con base cilindrica in marmo di Carrara e anello in metallo finitura peltro con illuminazione integrata a LED dimmerabili 2700°K.

Table lamp with cylindrical base in Carrara marble and metal ring in pewter finish with integrated 2700°K dimmable LED lighting.

ARGO

Divano modulare con struttura in massello di noce canaletto wengè, puntali in metallo finitura cromo nero, rivestimento in tessuto Madras L1635/15 e tavolino integrato con piano in marmo Sahara Noir.

Modular sofa with frame in solid canaletto walnut wengè stained, feet in black chromed metal, cover in Madras var. L1635 and integrated coffee table with top in Sahara Noir marble.

QUADRIFOGLIO

Tavolino quadrato 150x150 cm con quattro gambe in massello di noce canaletto posizionate sui quattro angoli. Piano in cristallo trasparente (spessore mm. 15). Piastre e piedini in ottone spazzolato.

Square coffee table 150x150 cm with four legs in solid canaletto walnut placed on the corners. Clear glass top (thickness mm. 15). Brushed brass plates and feet.





tamok

tamok
G. & O. Buratti

HALO 40

Lampada da tavolo con base cilindrica in marmo di Carrara e anello in metallo finitura peltro con illuminazione integrata a LED dimmerabili 2700°K.

Table lamp with cylindrical base in Carrara marble and metal ring in pewter finish with integrated 2700°K dimmable LED lighting.

TAMOK

Madia in noce canaletta con profili in massello e piano in marmo Calacatto oro. Dotata di due scomparti con ante a battente. Nello scomparto di sinistra è presente un cassetto con due ripiani in cristallo trasparente, mentre nello scomparto di destra sono presenti tre ripiani in cristallo trasparente. Vano centrale a giorno con tre ripiani in legno. Spalle con piedino in ottone bronzato spazzolato.

Cupboard in canaletta walnut with top in Calacatta gold marble and edges in solid canaletta walnut. Equipped with two compartments with hinged doors. In the left compartment there is a drawer with two clear glass shelves, while the right compartment has three clear glass shelves. Open central container with two wooden shelves. Sides with feet in bronzed brushed brass.







tamok

tamok
G. & O. Buratti

HALO 40

Lampada da tavolo con base cilindrica in marmo di Carrara e anello in metallo finitura peltro con illuminazione integrata a LED dimmerabili 2700°K.

Table lamp with cylindrical base in Carrara marble and metal ring in pewter finish with integrated 2700°K dimmable LED lighting.

TAMOK

Madia in noce canaletta con profili in massello e piano in marmo Calacatto oro. Dotata di due scomparti con ante a battente. Nello scomparto di sinistra è presente un cassetto con due ripiani in cristallo trasparente, mentre nello scomparto di destra sono presenti tre ripiani in cristallo trasparente. Vano centrale a giorno con tre ripiani in legno. Spalle con piedino in ottone bronzato spazzolato.

Cupboard in canaletta walnut with top in Calacatta gold marble and edges in solid canaletta walnut. Equipped with two compartments with hinged doors. In the left compartment there is a drawer with two clear glass shelves, while the right compartment has three clear glass shelves. Open central container with two wooden shelves. Sides with feet in bronzed brushed brass.





lum lum

D. Dolcini

SERENA

Sedia con braccioli con struttura in massello di frassino tinto canapa e rivestimento in Fashion var. 06J.

Armchair with frame in solid ash canapa stained and cover in Fashion var. 06J.

LUM 147 e 180

Lampada da terra in massello di frassino tinto canapa con base in finitura Bronzoro e diffusore in vetro opalino bianco. Interruttore dimmerabile touch integrato.

Floor lamp in solid ash canapa stained with base in Bronzoro finish and diffuser in white opal glass. Integrated dimmable touch switch.





mary

mary
P. Jouin

JELLY H 40 TONDO

Tavolino tondo con base in metallo cromo nero e colonna centrale in massello di noce canaletta tinta wengè. Piano in vetro fuso fumè con piastra in metallo.

Round side table with black chromed metal base and central pole in canaletta walnut wengè stained. Top in smoked cast glass with metal plate.

MARY

Mobile bar con due vani con ante curvate in noce canaletta con dettaglio in vetro Ice. Vano superiore con fondale rivestito in ottone spazzolato. Vano inferiore con ripiano in legno.

Illuminazione superiore a LED ricaricabile tramite USB con accensione tramite sensore di presenza.

Bar cabinet equipped with two compartments with curved doors and Ice glass detail. Upper compartment with covered back in brushed brass. Lower compartment with wooden shelf. Upper LED lighting rechargeable by USB with human presence sensor.





tiara

tiara
C. Ballabio

TIARA

Sedia con braccioli con struttura in massello di frassino tinto canapa e sedile imbottito con rivestimento in Hound var. L1640/03.

Chair with arms with frame in solid ash canapa stained and cover in Hound var. L1640/03.





dafto

dafto
S. Tollgard - F. Castellani

SERENA

Sedia con braccioli con struttura in massello di frassino tinto canapa e rivestimento in Fashion var. 06J.

Armchair with frame in solid ash canapa stained and cover in Fashion var. 06J.

DAFTO BOX LOW

Scatola per Dafto in frassino tinto canapa con coperchio e maniglia in cuoietto grigio scuro.

Box for Dafto dressing table in ash canapa stained with Cuoietto leather lid and handle.

DAFTO

Scrittoio in massello di frassino tinto canapa, struttura in metallo Bronzoro e piano in cuoietto grigio scuro con due cassetti portaoggetti con maniglie in cuoietto e fondo rivestito in microfibra. Nella parte posteriore sono presenti due vani con apertura pushpull con funzione passacavi.

Desk in solid ash canapa stained, metal frame in Bronzoro finish and top in dark grey Cuoietto leather with two storage drawers with handles in Cuoietto leather and bottom covered in microfiber. On the top there are two containers with push-pull opening for cables management.





dafto box

dafto box
S. Tollgard - F. Castellani

DAFTO BOX

Scatole per Dafto in versione alta e bassa in frassino tinto canapa con coperchio e maniglia in cuoietto grigio scuro.

High and low version boxes for Dafto dressing table in ash canapa stained with dark grey Cuoietto leather lid and handle.



vera

vera bergere
G. & O. Buratti

VERA BERGERE

Poltrona con struttura in massello di noce canaletta, schienale in cuoietto grigio scuro e cuscini con rivestimento sfoderabile in Madras var. L1635/05.

Armchair with frame in solid canaletta walnut, back in dark grey cuoietto leather and cushions with removable cover in Madras var. L1635/05.





odino

odino
Molteni & Baron

ODINO OVALE

Specchio ovale da parete
oppure in appoggio con
cornice in frassino tinto
canapa.

*Oval mirror to be hung
to or to be leaned on the
wall with frame in ash
canapa stained.*



"1st PRIZE STUDENT CATEGORY
PORADA INTERNATIONAL
DESIGN AWARD 2018"

ninfea

ninfea
N. Devetag

TILLY

Sedia con braccioli con struttura in massello di noce canaletta e sedile imbottito con rivestimento in Hound var. L1640/03.

Chair with arms with frame in solid canaletta walnut and upholstered seat in Hound var. L1640/03.

NINFEA

Scrittoio in noce canaletta con struttura in metallo grigio peltro e dettagli in ottone spazzolato. Piano in cuoietto grigio scuro con cornice in legno massello dotato di vano portaoggetti in lamiera con coperchio in massello di noce canaletta. Specchio spostabile lateralmente.

Writing desk in solid canaletta walnut with frame in grey pewter metal and details in brushed brass. Top in dark grey Cuoietto leather with frame in solid wood equipped with a tin-plated storage compartment in solid canaletta walnut. Possibility of moving the mirror sideways.





ziggy bed

ziggy
C. Ballabio

ZIGGY NIGHT 2

Comodino con struttura in massello di frassino tinto wengè e piano in marmo Sahara Noir.

Night table with frame in solid ash wengè stained and Sahara Noir marble top.

ZIGGY BED

Letto a baldacchino con struttura in massello di frassino tinto wengè, testata e fasce laterali imbottite con rivestimento in Velvet var. 77.

Canopied bed with frame in solid ash wengè stained, headboard and bedbase with cover in Velvet var. 77.



jelly

jelly
C. Ballabio

JELLY H55 e H40

Tavolini tondi con base in metallo cromo nero e colonna centrale in massello di noce canaletta tinta wengè. Piani in vetro fuso colore verde e fumè.

Round side tables with base in black chromed metal and central column in solid canaletta walnut wengè stained. Tops in green and smoked cast glass.





jelly

jelly
C. Ballabio

JELLY H55

Tavolino tondo con base in ottone spazzolato e colonna centrale in massello di noce canaletta. Piano in vetro fuso colore verde.

Round side table with base in brushed brass and central column in solid canaletta walnut. Top in green cast glass.







halo

halo
D. Dolcini

HALO 60

Lampada da tavolo con base cilindrica in marmo di Carrara e anello in metallo finitura peltro con illuminazione integrata a LED dimmerabili 2700°K.

Table lamp with cylindrical base in Carrara marble and metal ring in pewter finish with integrated 2700°K dimmable LED lighting.



**HALO 40**

Lampada da tavolo con base cilindrica in marmo di Carrara e anello in metallo finitura peltro con illuminazione integrata a LED dimmerabili 2700°K.

Table lamp with cylindrical base in Carrara marble and metal ring in pewter with integrated 2700°K dimmable LED lighting.

TAMOK NIGHT 2

Comodino a due cassetti in noce canaletta con profili in massello e piano in marmo sahara noir. Spalle con piedino in ottone bronzato spazzolato.

Night table with two drawers in canaletta walnut with top in Sahara Noir marble and edges in solid canaletta walnut. Sides with feet in bronzed brushed brass.

tamok night

G. & O. Buratti

TAMOK NIGHT 3

Cassettiera a tre cassetti in noce canaletta con profili in massello e piano in marmo sahara noir. Spalle con piedino in ottone bronzato spazzolato.

Three drawers chest in canaletta walnut with edges in solid canaletta walnut and top in Sahara Noir marble. Sides with feet in bronzed brushed brass.







**ARIA comp. G**

Libreria modulare con colonne portanti in frassino tinto canapa e fissaggio a parete. Contenitori in frassino con due ante a battente e un ripiano interno in cristallo fumé. Mensole in frassino supportate da un telaio in alluminio nero opaco.

Modular bookcase with columns in ash canapa stained to be fixed to the wall. Containers in ash with two hinged doors and one shelf in smoked glass. Shelves in ash with frame in black matt metal.

AXXIA

Panca rettangolare con struttura in metallo Bronzoro e cornice in massello di noce canaletta. Rivestimento in Thalys var. 2015.

Rectangular bench with metal frame in Bronzoro finish and frame in solid canaletta walnut. Cover in Thalys var. 2015.



aria

aria
D. Dolcini

ARIA comp. G

Libreria modulare con colonne portanti in frassino tinto canapa e fissaggio a parete. Contenitori in frassino con due ante a battente e un ripiano interno in cristallo fumé. Mensole in frassino supportate da un telaio in alluminio nero opaco.

Modular bookcase with columns in ash canapa stained to be fixed to the wall. Containers in ash with two hinged doors and one shelf in smoked glass. Shelves in ash with frame in black matt metal.



ARIA comp. F

Libreria modulare con colonne portanti in frassino tinto canapa e fissaggio a parete. Contenitori in frassino con anta a ribalta e un ripiano interno in cristallo fumé. Mensole in frassino supportate da un telaio in alluminio nero opaco.

Modular bookcase with columns in ash canapa stained to be fixed to the wall. Containers in ash with flap doors and one shelf in smoked glass. Shelves in ash with frame in black matt metal.

TIARA

Sedia con braccioli con struttura in massello di frassino tinto wengè e sedile imbottito con rivestimento in Wool var. 810.

Chair with arms with frame in solid ash wengè stained and upholstered seat in Wool var. 810.

ARGO

Divano modulare con struttura in massello di noce canaletta tinto wengè, puntali in metallo finitura cromo nero, rivestimento in tessuto Madras var. L1635/15.

Modular sofa with frame in solid canaletta walnut wengè stained, feet in black chromed metal, cover in Madras var. L1635.















pilar

pilar
M. Marconato - T. Zappa

LIP

Sedia con struttura in massello di frassino tinto wengè e rivestimento in Wool var. 810.

Chair with frame in solid ash wengè stained and cover in Wool var. 810.

PILAR MIX TONDO 160

Tavolo da pranzo con base costituita da diversi elementi in massello di frassino tinto caffè e wengè e piano in cristallo trasparente fissato attraverso piastre in metallo finitura antracite spazzolato. Elementi di unione in metallo finitura cromo nero.

Dining table with base made up of different elements in solid ash caffè and wengè stained and top in transparent glass fixed on metal plates in brushed anthracite. Joints in black chromed metal.



PILAR MIX TONDO 160

Tavolo da pranzo con base costituita da diversi elementi in massello di frassino tinto caffè e wengè e piano in cristallo trasparente fissato attraverso piastre in metallo finitura antracite spazzolato. Elementi di unione in metallo finitura cromo nero.

Dining table with base made up of different elements in solid ash caffè and wengè stained and top in transparent glass fixed on metal plates in brushed anthracite. Joints in black chromed metal.

LUM 147 e 180

Lampada da terra in massello di frassino tinto canapa con base in finitura Bronzoro e diffusore in vetro opalino bianco. Interruttore dimmerabile touch integrato.

Floor lamp in solid ash canapa stained with base in Bronzoro finish and diffuser in white opal glass. Integrated dimmable touch switch.

LIP

Sedia con struttura in massello di frassino tinto wengè e rivestimento in Dorian var. 27.

Chair with frame in solid ash wengè stained and cover in Dorian var. 27.

lip
lip
M. Marconato - T. Zappa





odino

odino
Molteni & Baron

VERA

Poltrona con struttura in massello di noce canaletta, schienale in cuoietto grigio scuro e cuscini con rivestimento sfoderabile in Ikat var. 05.

Armchair with frame in solid canaletta walnut, back in dark grey Cuoietto leather and cushions with removable cover in Ikat var. 05.

JELLY 55

Tavolino tondo con piano in vetro fuso fumè, base in metallo cromo nero e colonna centrale in massello di noce canaletta tinto wengè.

Oval side table with smoked cast glass top, black chromed metal base and central column in solid canaletta walnut wengè stained.

ODINO TONDO

Specchio tondo da parete oppure in appoggio con cornice in frassino tinto wengè.

Round mirror to be hung to or to be leaned on the wall with frame in ash wengè stained.



VERA

Poltrona con struttura in massello di noce canaletta, schienale in cuoietto grigio scuro e cuscini con rivestimento sfoderabile in Ikat var. 05.

Armchair with frame in solid canaletta walnut, back in dark grey Cuoietto leather and cushions with removable cover in Ikat var. 05.

SAFFO

Scrittoio con cassetto in massello di noce canaletta con vani portaoggetti e passacavi a scomparsa.

Writing desk with drawer in solid canaletta walnut with compartments and totally hidden cable managements.

NISSA CON BRACCIOLI

Sedia con braccioli con struttura in massello di noce canaletta e rivestimento in Armam var. 1569/13.

Chair with arms with frame in solid canaletta walnut and cover in Arman var. 1569/13.

hilton

T. Colzani

HILTON

Paravento a tre elementi pieghevoli in massello di noce canaletta. Cerniere in metallo finitura Bronzoro.

Room divider with three folding elements in solid canaletta walnut. Metal hinges in Bronzoro finish.



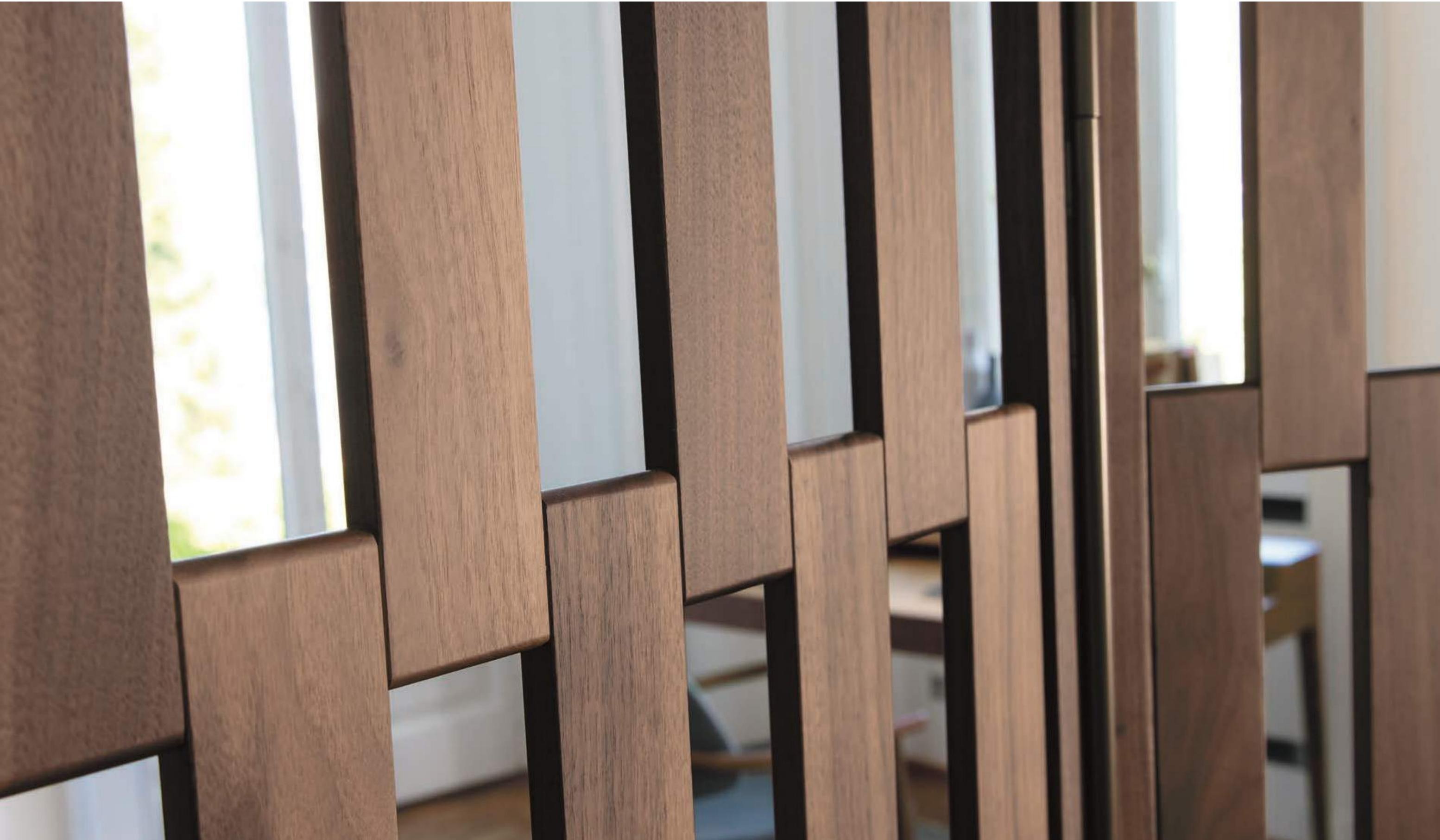

FRITZ 4

Tavolino con base in metallo nero opaco con puntali in ottone spazzolato e piano quadrato in legno con cornice in massello di noce canaletta tinto wengè.

Side table with base in matt black metal with brushed brass end-feet and square top with frame in solid canaletta walnut wengè stained.

ATLANTE BAR

Mobile bar attrezzato in noce canaletta, ante in cristallo fumè e piano in legno. Dotato di tre vani interni con portabicchieri e un cassetto con chiusura rallentata. Ripiano interno in cristallo fumè. Il vano centrale è illuminato tramite un sistema di luci a LED regolabile con telecomando.

Bar cabinet in canaletta walnut with doors in smoked glass and wooden top. Equipped with three compartments with glass holder and drawer with soft closure. Inside shelf in smoked glass. The central compartment is LED lighted through a remote control system.

atlante atlante bar
C. Ballabio



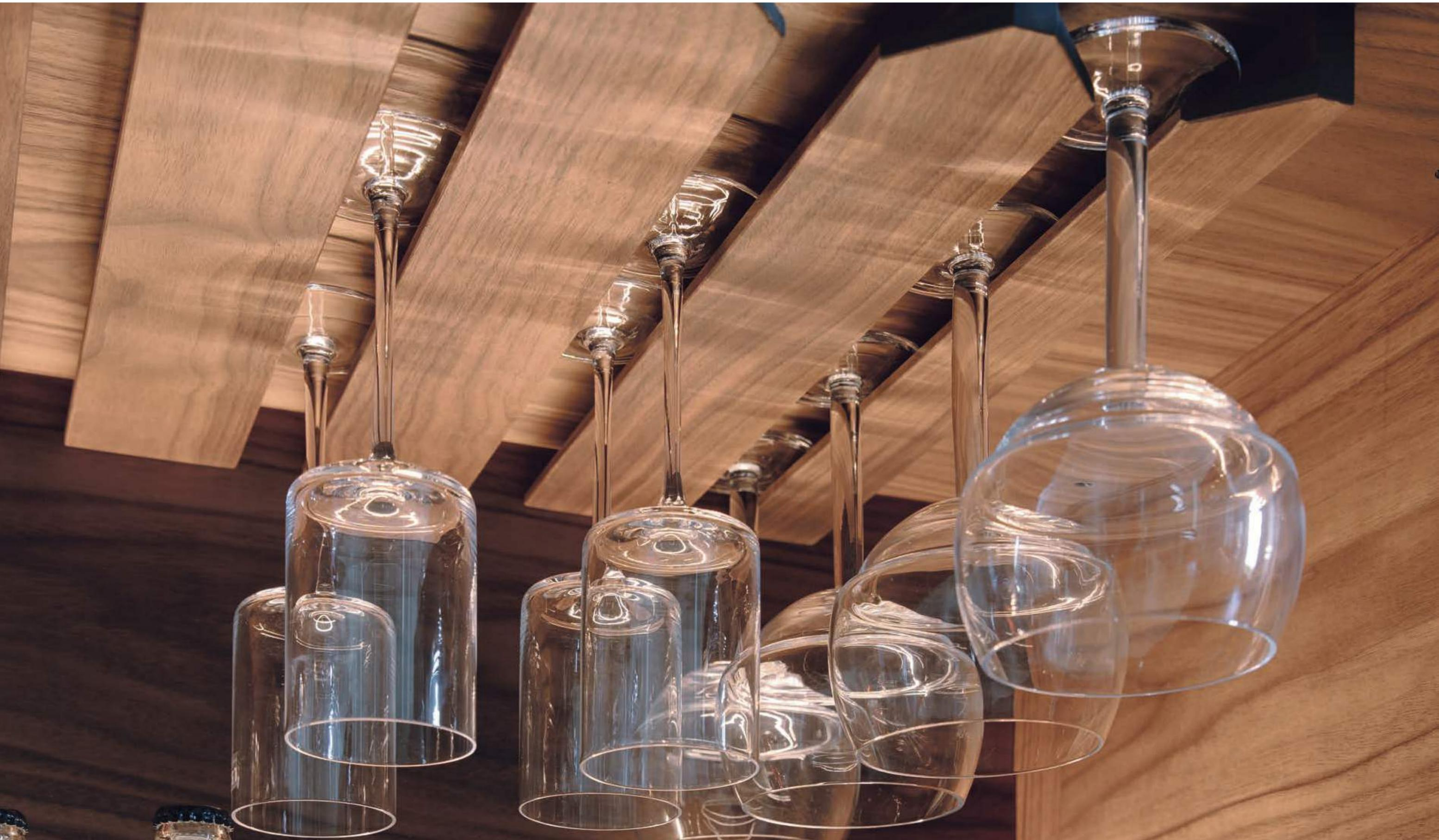



quadrifoglio

quadrifoglio
C. Ballabio

SERENA

Sedia con braccioli con struttura in massello di frassino tinto canapa e rivestimento in Fashion var. 06J.

Armchair with frame in solid ash canapa stained and cover in Fashion var. 06J.

QUADRIFOGLIO

Tavolo da pranzo rettangolare 300x115 cm con quattro gambe rientranti e cornice del piano in massello di frassino tinto canapa. Piedini in ottone spazzolato.

Rectangular dining table 300x115 cm with four recessed legs and top frame in solid ash canapa stained. Brushed brass feet.





serena

serena
E. Gallina

SERENA

Sedia con braccioli con struttura in massello di frassino tinto canapa e rivestimento in Fashion var. 06J.

Armchair with frame in solid ash canapa stained and cover in Fashion var. 06J.





sveva

G. & O. Buratti

SVEVA

Sedia con struttura in massello di frassino tinto noce canaletta, schienale in cuoietto Sabbia e rivestimento in tessuto Loom var. L1534/13.

Chair with frame in ash canaletta walnut stained, back in Cuoietto Sabbia leather and cover in Loom var. L1534/13.

axxia

axxia
T. Colzani

AXXIA

Panca rettangolare con struttura in metallo Bronzoro e cornice in massello di noce canaletta. Rivestimento in Thalys var. 2015.

Rectangular bench with metal structure in Bronzoro finish, solid canaletta walnut seat frame and cover in Thalys var. 2015.







drift

drift
M. Marconato - T. Zappa

DRIFT

Credenza estensibile in larghezza con struttura in frassino tinto wengè e basamento laccato nero. Dotata di due contenitori con ante, due cassetti e un vano a giorno.

Extendable sideboard with frame in ash wengè stained and black lacquered base. Equipped with two containers with hinged doors, two drawers and an open container.







**BAYUS 8**

Console in noce canaletta a quattro cassetti con frontali in cuoio grigio scuro. Profili piano e divisori vani in massello di noce canaletta. Base in metallo Bronzoro e puntali in ottone spazzolato.

Console in solid canaletta walnut with four drawers with fronts in dark grey Cuoietto leather. Top edges and compartment dividers in solid canaletta walnut. Bronzoro metal base and brushed brass end-feet.

bayus 8 bayus 8
G. & O. Buratti





tiara

C. Ballabio

TIARA

Sedia con braccioli con struttura in massello di frassino tinto wengè e sedile imbottito con rivestimento in Wool var. 810.

Chair with arms with frame in solid ash wengè stained and upholstered seat in Wool var. 810.





dafto

dafto
S. Tollgard - F. Castellani

DAFTO

Coiffeuse in massello di frassino tinto wengè, struttura in metallo Bronzoro e piano in cuoietto grigio scuro con due cassetti portaoggetti con maniglie in cuoietto e fondo rivestito in microfibra. Nella parte posteriore sono presenti uno specchio tondo e due vani con apertura pushpull con funzione passacavi e portaoggetti.

Dressing table in solid ash wengè stained, metal frame in Bronzoro finish and top in dark grey Cuoietto leather with two storage drawers with handles in Cuoietto leather and bottom covered by microfiber. On the top there are two containers with push-pull opening for cables management. Round mirror available as an option.





ziggy bed

ziggy bed
C. Ballabio

ZIGGY BED

Letto a baldacchino con struttura in massello di frassino tinto canapa, testata e fasce laterali imbottite con rivestimento in Madras var. L 1635/06.

Canopied bed with frame in solid ash canapa stained, upholstered headboard and bed base in Madras var. L 1635/06.







halo

D. Dolcini

HALO 60 e 40

Lampada da tavolo con base cilindrica in marmo di Carrara e anello in metallo finitura peltro con illuminazione integrata a LED dimmerabili 2700°K.

Table lamp with cylindrical base in Carrara marble and metal ring in pewter finish with integrated 2700°K dimmable LED lighting.



igor

igor
D. Dolcini

IGOR

Portabiti in massello di noce canaletta con elemento di base in marmo di Carrara. Componenti in metallo con finitura ottone spazzolato.

Clothes-stand in solid canaletta walnut and base in Carrara marble. Metal components in brushed brass finish.



technical drawings

informazioni
tecniche

Porada se reserva el derecho de cambiar, en cualquier momento y sin previo aviso, las características técnicas y las medidas de los modelos incluidos en este catálogo. Las medidas están en cm. y en pulgadas.

Porada se réserve le droit d'apporter à ses produits toutes améliorations techniques et esthétiques, compris modifications des dimensions et matériaux, sans préavis. Les mesures sont en cm. et en pouces.

Porada behält sich das Recht vor, Ihren Modellen technische bzw optische Änderungen, inklusiv Änderungen an Masse, ohne vorherige Ankündigung vorzunehmen. Die Maße sind in cm. und in Zoll.

Porada reserves the right to change, at any time and without notice, the technical specifications, including modifications of sizes, of any product illustrated in this catalogue. The measures are in cm. and inches.

Porada si riserva la facoltà di modificare, in qualunque momento e senza preavviso, le caratteristiche tecniche e le misure dei modelli illustrati nel presente catalogo. Le misure sono in cm. e in pollici.

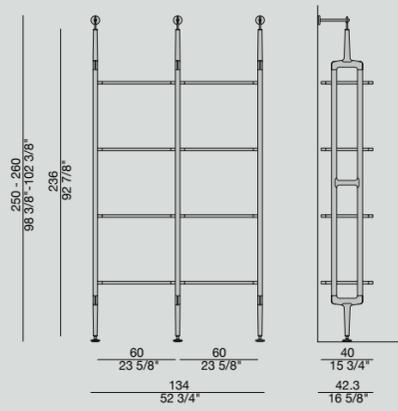

Aria comp. A

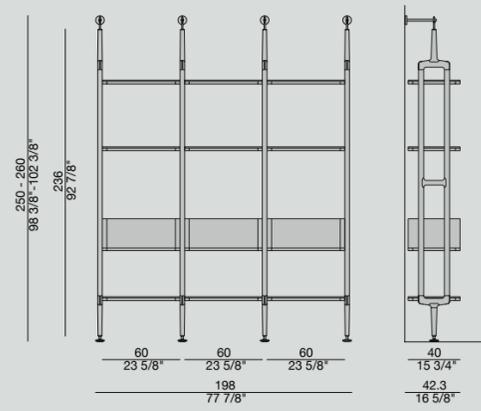

Aria comp. B

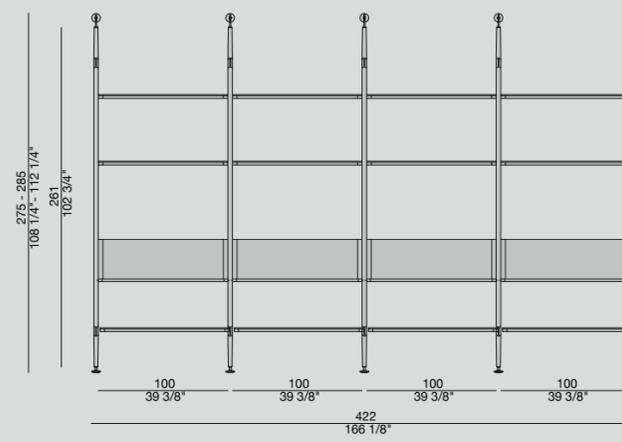

Aria comp. F

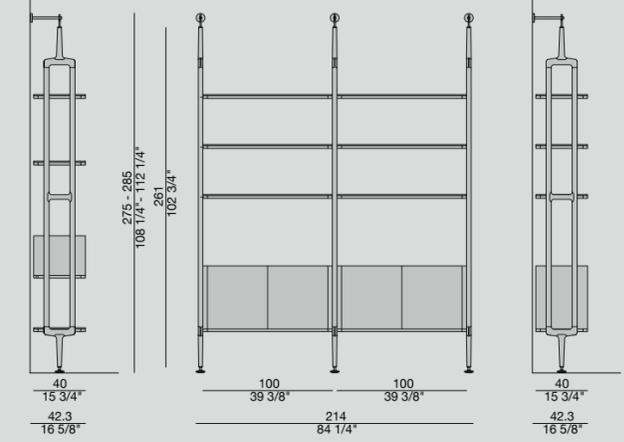

Aria comp. G

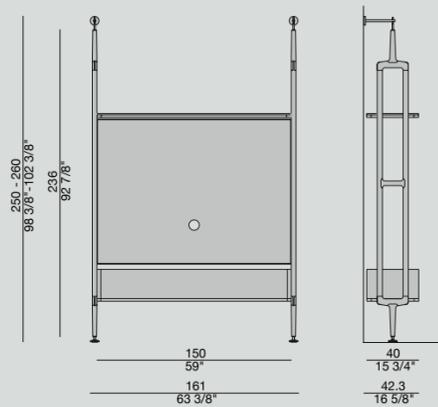

Aria comp. C

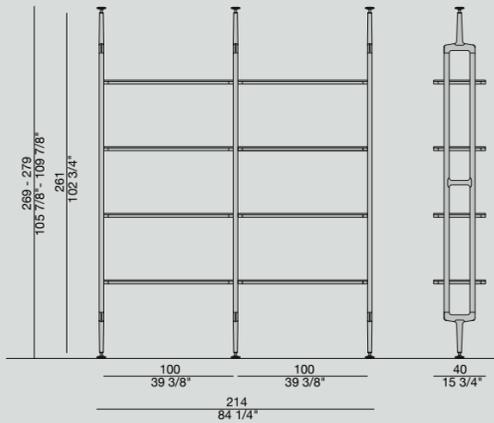

Aria comp. D

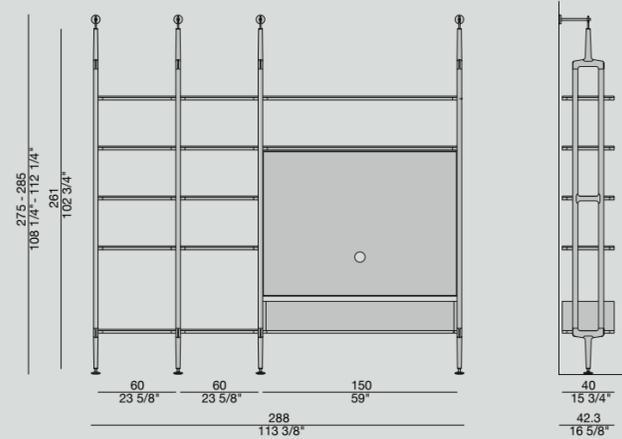

Aria comp. H

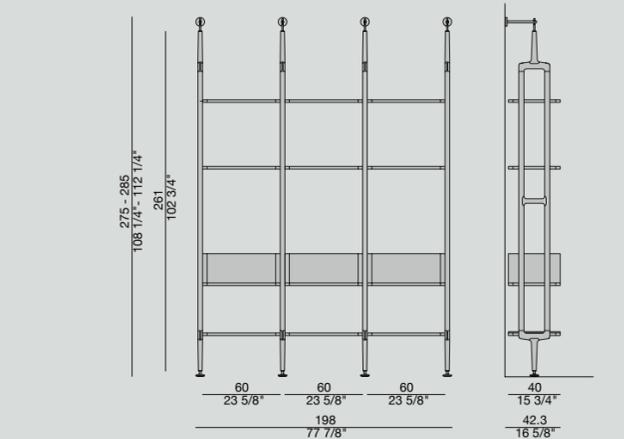

Aria comp. I

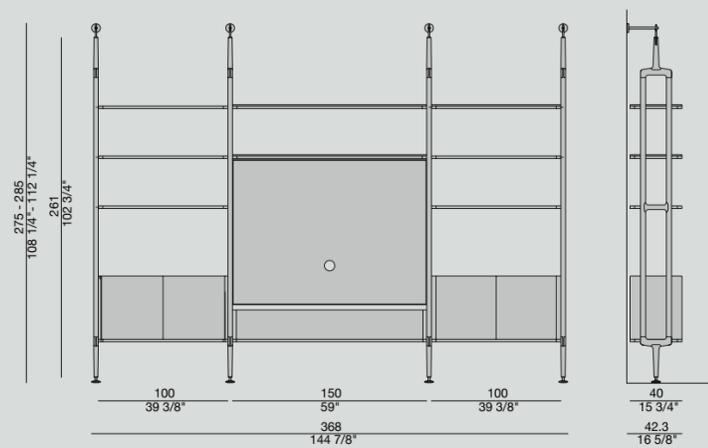

Aria comp. E

aria

D. Dolcini

ESSENZA - WOOD - MADERA

frassino naturale

natural ash

fresno natural

frassino tinto moka

ash moka stained

fresno teñido moka

frassino tinto noce canaletta

ash canaletta walnut stained

fresno teñido nogal canaletta

frassino tinto wengé

ash wengé stained

fresno teñido wengé

frassino tinto canapa

ash canapa stained

fresno teñido canapa

frassino tinto caffè

ash caffè stained

fresno teñido caffè

CRISTALLO - GLASS - CRISTAL METALLO - METAL - METAL

fumé

smoked

ahumado

nero opaco

black matt

negro mate

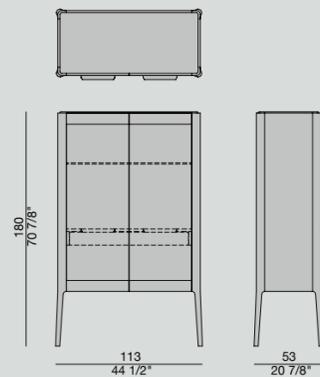

atlante bar

C. Ballabio

ESSENZA - WOOD - MADERA

noce canaletta

canaletta walnut

nogal canaletta

noce canaletta tinto moka

canaletta walnut moka stained

nogal canaletta teñido moka

noce canaletta tinto wengé

canaletta walnut wengé stained

nogal canaletta teñido wengé

laccato opaco poro chiuso

matt lacquered closed pore

lacado mate poro cerrado

frassino naturale

natural ash

fresno natural

frassino tinto moka

ash moka stained

fresno teñido moka

frassino tinto noce canaletta

ash canaletta walnut stained

fresno teñido nogal canaletta

frassino tinto wengé

ash wengé stained

fresno teñido wengé

frassino tinto canapa

ash canapa stained

fresno teñido canapa

frassino tinto caffè

ash caffè stained

fresno teñido caffè

laccato opaco poro aperto

matt lacquered open pore

lacado mate poro abierto

bayus 8

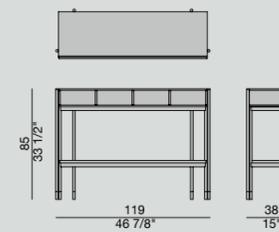

ESSENZA - WOOD - MADERA

noce canaletta

canaletta walnut

nogal canaletta

noce canaletta tinto moka

canaletta walnut moka stained

nogal canaletta teñido moka

noce canaletta tinto wengé

canaletta walnut wengé stained

nogal canaletta teñido wengé

METALLO - METAL - METAL

bronzoro

bayus 5-6-8 cassetto

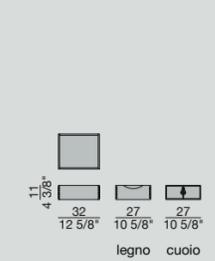

RIVESTIMENTO - COVER - FUNDA

cuoio

bayus 8

G. & O. Buratti

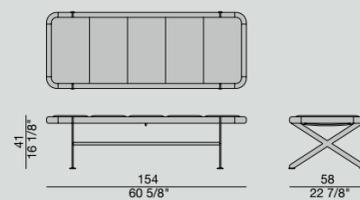

axxia

T. Colzani

ESSENZA - WOOD - MADERA

noce canaletta

canaletta walnut

nogal canaletta

noce canaletta tinto moka

canaletta walnut moka stained

nogal canaletta teñido moka

noce canaletta tinto wengé

canaletta walnut wengé stained

nogal canaletta teñido wengé

laccato opaco poro chiuso

matt lacquered closed pore

lacado mate poro cerrado

METALLO - METAL - METAL

bronzoro

dafto con specchio

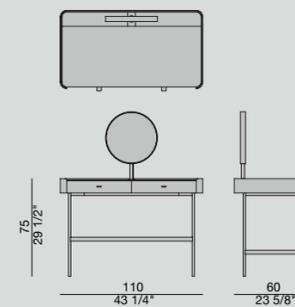

ESSENZA - WOOD - MADERA

frassino naturale

natural ash

fresno natural

frassino tinto moka

ash moka stained

fresno teñido moka

frassino tinto noce canaletta

ash canaletta walnut stained

fresno teñido nogal canaletta

frassino tinto wengé

ash wengé stained

fresno teñido wengé

frassino tinto canapa

ash canapa stained

fresno teñido canapa

frassino tinto caffè

ash caffè stained

fresno teñido caffè

dafto box low

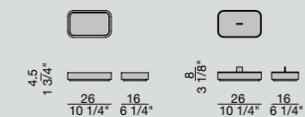

dafto box high

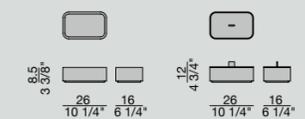

RIVESTIMENTO - COVER - FUNDA

cuoietto

METALLO - METAL - METAL

bronzoro

dafto

S. Tollgard - F. Castellani

CHIUSA - CLOSED



APERTA - OPEN

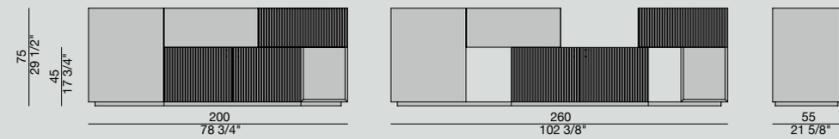

ESSENZA - WOOD - MADERA

frassino tinto wengé

ash wengé stained

fresno teñido wengé

frassino tinto canapa

ash canapa stained

fresno teñido canapa

drift

M. Marconato - T. Zappa

hilton 2

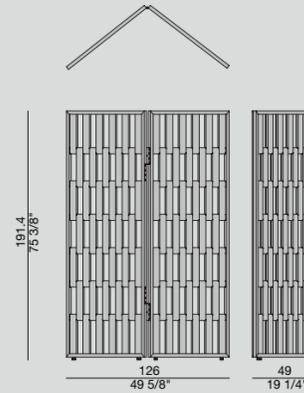

hilton 3

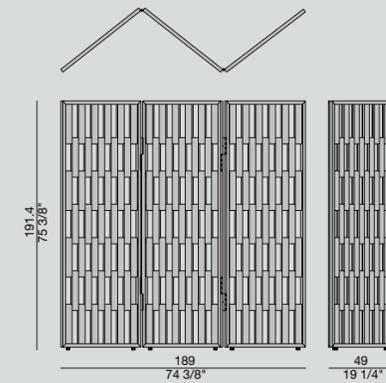
**hilton**

T. Colzani

ESSENZA - WOOD - MADERA

noce canaletta

canaletta walnut

nogal canaletta

halo 40

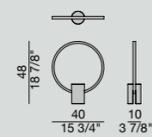

halo 60

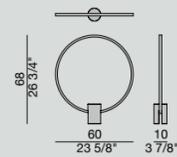
**halo**

D. Dolcini

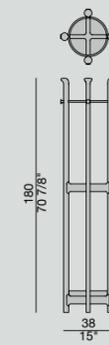

ESSENZA - WOOD - MADERA

noce canaletta

canaletta walnut

nogal canaletta

noce canaletta tinto moka

canaletta walnut moka stained

nogal canaletta teñido moka

noce canaletta tinto wengé

canaletta walnut wengé stained

nogal canaletta teñido wengé

laccato opaco poro chiuso

matt lacquered closed pore

lacado mate poro cerrado

METALLO - METAL - METAL

ottone spazzolato

brushed brass

latón cepillado

MARMO - MARBLE - MARMOL

Carrara

MARMO - MARBLE - MARMOL METALLO - METAL - METAL

Carrara**grigio peltro**

grey pewter

gris peltre

igor

D. Dolcini

jelly h40 ovale

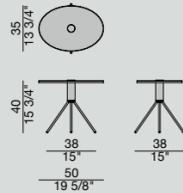

jelly h40 tondo

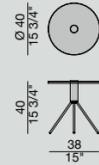

Jelly h55 ovale

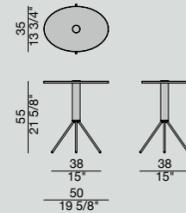

Jelly h55 tondo

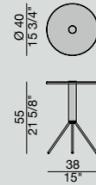

jelly
C. Ballabio

ESSENZA - WOOD - MADERA

noce canaletta

canaletta walnut

nogal canaletta

noce canaletta tinto wengé

canaletta walnut wengé stained

nogal canaletta teñido wengé

METALLO - METAL - METAL

cromo nero

black chromed

cromo negro

ottone spazzolato

brushed brass

latón cepillado

CRISTALLO - GLASS - CRISTAL

vetro fuso fumé

smoked cast glass

vidrio fundido ahumado

vetro fuso verde

green cast glass

vidrio fundido verde

lum 147

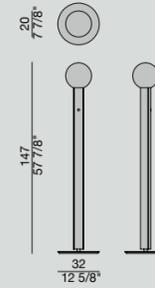

lum 180

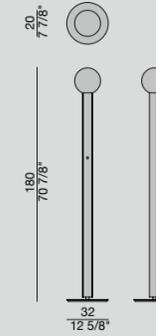

lum
D. Dolcini

ESSENZA - WOOD - MADERA

noce canaletta

canaletta walnut

nogal canaletta

frassino tinto wengé

ash wengé stained

fresno teñido wengé

frassino tinto canapa

ash canapa stained

fresno teñido canapa

METALLO - METAL - METAL

frassino tinto caffè

ash caffè stained

fresno teñido caffè

METALLO - METAL - METAL

bronzoro

DIFFUSORE - DIFFUSER - DIFUSOR

vetro opalino bianco

white opal glas

vidrio opalino blanco

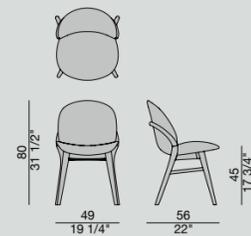

lip

M. Marconato - T. Zappa

ESSENZA - WOOD - MADERA

frassino naturale

natural ash

fresno natural

frassino tinto moka

ash moka stained

fresno teñido moka

frassino tinto noce canaletta

ash canaletta walnut stained

fresno teñido nogal canaletta

frassino tinto wengé

ash wengé stained

fresno teñido wengé

frassino tinto canapa

ash canapa stained

fresno teñido canapa

frassino tinto caffè

ash caffè stained

fresno teñido caffè

laccato opaco poro aperto

matt lacquered open pore

lacado mate poro abierto

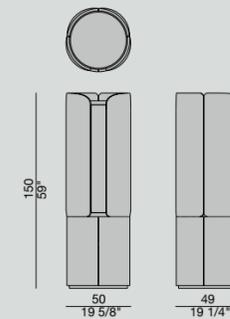

mary

P. Jouin

ESSENZA - WOOD - MADERA

noce canaletta

canaletta walnut

nogal canaletta

noce canaletta tinto moka

canaletta walnut moka stained

nogal canaletta teñido moka

noce canaletta tinto wengé

canaletta walnut wengé stained

nogal canaletta teñido wengé

METALLO - METAL - METAL

ottone spazzolato

brushed brass

latón cepillado

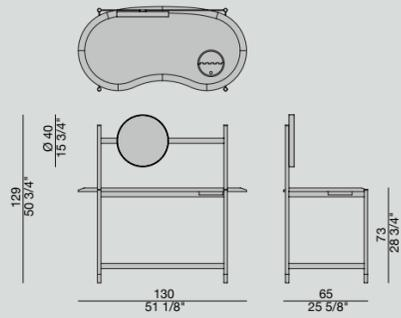

"1st PRIZE STUDENT CATEGORY
PORADA INTERNATIONAL
DESIGN AWARD 2018"

nifea

N. Devetag

ESSENZA - WOOD - MADERA

noce canaletta

canaletta walnut

nogal canaletta

noce canaletta tinto moka

canaletta walnut moka stained

nogal canaletta teñido moka

noce canaletta tinto wengé

canaletta walnut wengé stained

nogal canaletta teñido wengé

laccato opaco poro chiuso

matt lacquered closed pore

lacado mate poro cerrado

METALLO - METAL - METAL

grigio peltro

grey pewter

gris peltre

ottone spazzolato

brushed brass

latón cepillado

RIVESTIMENTO - COVER - FUNDA

cuoietto

odino ovale

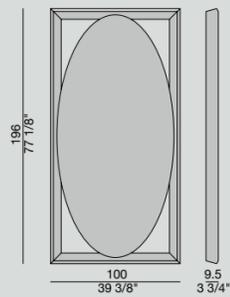

odino tondo

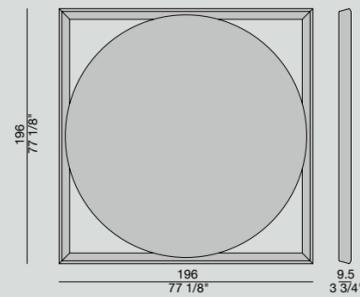

odino

Molteni & Baron

ESSENZA - WOOD - MADERA

frassino naturale

natural ash

fresno natural

frassino tinto moka

ash moka stained

fresno teñido moka

frassino tinto noce canaletta

ash canaletta walnut stained

fresno teñido nogal canaletta

frassino tinto wengé

ash wengé stained

fresno teñido wengé

frassino tinto canapa

ash canapa stained

fresno teñido canapa

frassino tinto caffè

ash caffè stained

fresno teñido caffè

laccato opaco poro aperto

matt lacquered open pore

lacado mate poro abierto

SPECCHIO - MIRROR - ESPEJO

naturale - clear - natural

pilar tondo

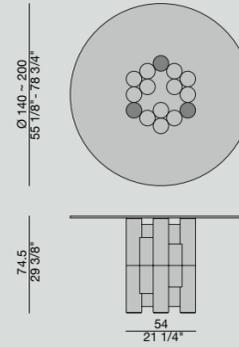

pilar ovale

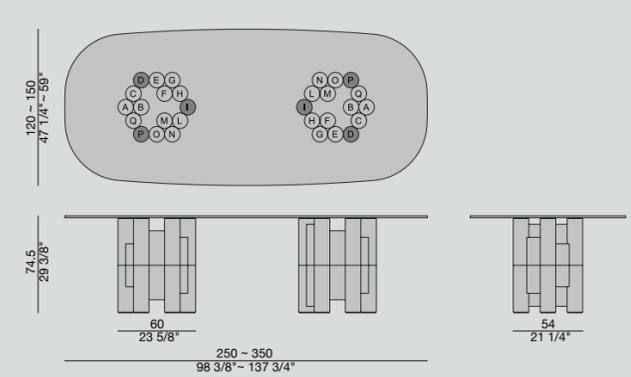

pilar rettangolare

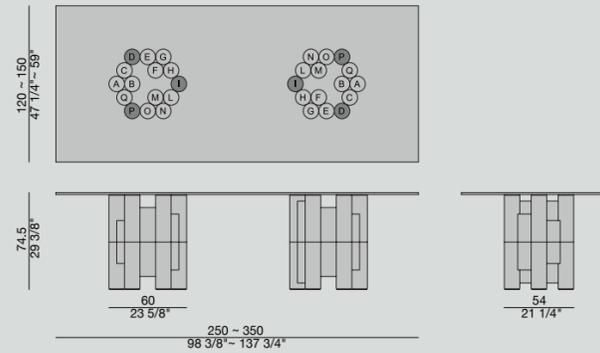

pilar

M. Marconato - T. Zappa

ESSENZA - WOOD - MADERA

frassino naturale

natural ash

fresno natural

frassino tinto moka

ash moka stained

fresno teñido moka

frassino tinto noce canaletta

ash canaletta walnut stained

fresno teñido nogal canaletta

frassino tinto wengé

ash wengé stained

fresno teñido wengé

frassino tinto canapa

ash canapa stained

fresno teñido canapa

frassino tinto caffè

ash caffè stained

fresno teñido caffè

laccato opaco poro aperto

matt lacquered open pore

lacado mate poro abierto

METALLO - METAL - METAL

Cromo nero

black chromed

Cromo negro

CRISTALLO - GLASS - CRISTAL

trasparente

clear

transparente

quadrifoglio tavolino quadrato

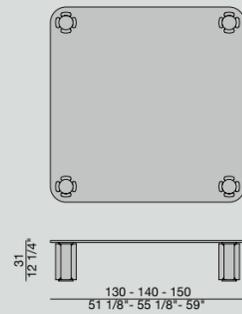

quadrifoglio tavolino rettangolare

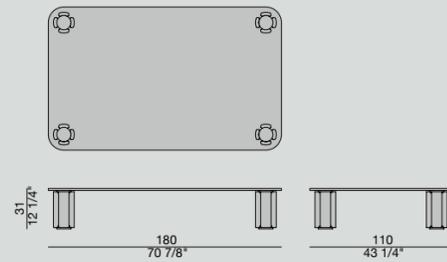

ESSENZA - WOOD - MADERA

noce canalettacanaletta walnut
nogal canaletta**noce canaletta tinto moka**canaletta walnut moka stained
nogal canaletta teñido moka**noce canaletta tinto wengé**canaletta walnut wengé stained
nogal canaletta teñido wengé**laccato opaco poro chiuso**matt lacquered closed pore
lacado mate poro cerrado**frassino naturale**natural ash
fresno natural**frassino tinto moka**ash moka stained
fresno teñido moka**frassino tinto noce canaletta**ash canaletta walnut stained
fresno teñido nogal canaletta**frassino tinto wengé**ash wengé stained
fresno teñido wengé

METALLO - METAL - METAL

ottone spazzolatobrushed brass
latón cepillado

quadrifoglio

C. Ballabio

CRISTALLO - GLASS - CRISTAL

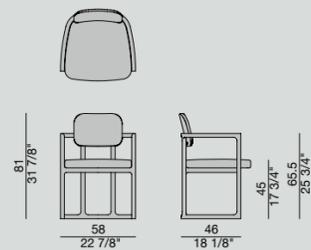
trasparenteclear
transparente

ESSENZA - WOOD - MADERA

frassino naturalenatural ash
fresno natural**frassino tinto moka**ash moka stained
fresno teñido moka**frassino tinto noce canaletta**ash canaletta walnut stained
fresno teñido nogal canaletta**frassino tinto wengé**ash wengé stained
fresno teñido wengé**frassino tinto canapa**ash canapa stained
fresno teñido canapa**frassino tinto caffè**ash caffè stained
fresno teñido caffè**laccato opaco poro aperto**matt lacquered open pore
lacado mate poro abierto

sveva

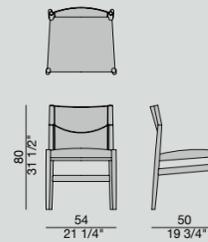

sveva con braccioli

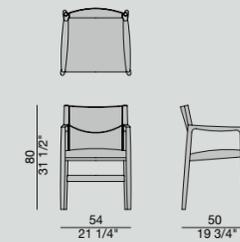

ESSENZA - WOOD - MADERA

frassino naturalenatural ash
fresno natural**frassino tinto moka**ash moka stained
fresno teñido moka**frassino tinto noce canaletta**ash canaletta walnut stained
fresno teñido nogal canaletta**frassino tinto wengé**ash wengé stained
fresno teñido wengé**frassino tinto canapa**ash canapa stained
fresno teñido canapa**frassino tinto caffè**ash caffè stained
fresno teñido caffè**laccato opaco poro aperto**matt lacquered open pore
lacado mate poro abierto

SCHIENALE - BACKREST - RESPALDO

cuoietto

tamok

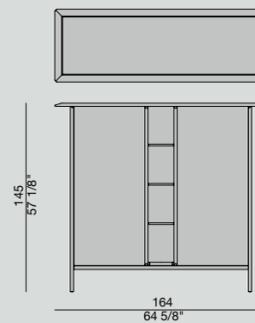

tamok night 2

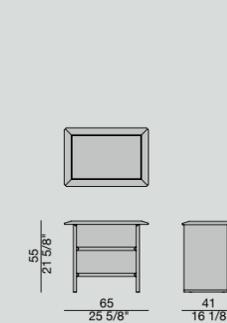

tamok night 3

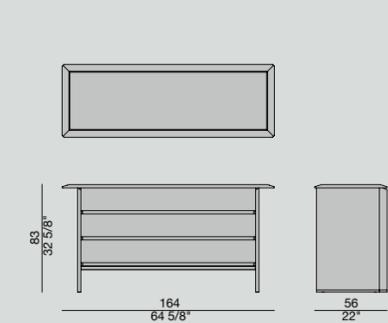

serena

E. Gallina

ESSENZA - WOOD - MADERA

noce canalettacanaletta walnut
nogal canaletta**noce canaletta tinto moka**canaletta walnut moka stained
nogal canaletta teñido moka**noce canaletta tinto wengé**canaletta walnut wengé stained
nogal canaletta teñido wengé

MARMO - MARBLE - MARMOL

marrone Emperador Darkbrown Emperador Dark
marrón Emperador Dark**bianco Calacatta oro**white Calacatta gold
blanco Calacatta oro**nero Sahara Noir**black Sahara Noir
negro Sahara Noir

METALLO - METAL - METAL

ottone bronzato spazzolatobronzed brushed brass
latón bronceado cepillado

ROCK

calacatta opacomatt calacatta
calacatta mate**emperador opaco**matt emperador
emperador mate**oxide black opaco**matt oxide black
oxide black mate

sveva

G. & O. Buratti

tamok

G. & O. Buratti

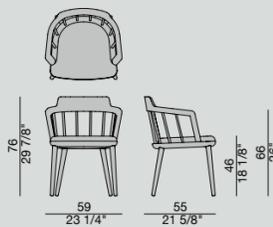

tiara

C. Ballabio

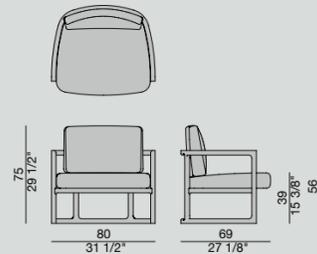

venus

E. Gallina

ESSENZA - WOOD - MADERA

frassino naturale

natural ash
fresno natural

frassino tinto moka

ash moka stained
fresno teñido moka

frassino tinto noce canaletta

ash canaletta walnut stained
fresno teñido nogal canaletta

frassino tinto wengé

ash wengé stained
fresno teñido wengé

frassino tinto canapa

ash canapa stained
fresno teñido canapa

frassino tinto caffè

ash caffè stained
fresno teñido caffè

laccato opaco poro aperto

matt lacquered open pore
lacado mate poro abierto

ESSENZA - WOOD - MADERA

frassino naturale

natural ash
fresno natural

frassino tinto moka

ash moka stained
fresno teñido moka

frassino tinto noce canaletta

ash canaletta walnut stained
fresno teñido nogal canaletta

frassino tinto wengé

ash wengé stained
fresno teñido wengé

frassino tinto canapa

ash canapa stained
fresno teñido canapa

frassino tinto caffè

ash caffè stained
fresno teñido caffè

laccato opaco poro aperto

matt lacquered open pore
lacado mate poro abierto

tortuga h35

tortuga h41

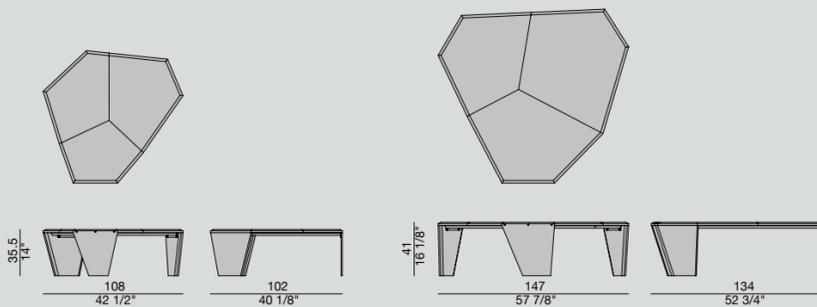

tortuga

Jiun Ho

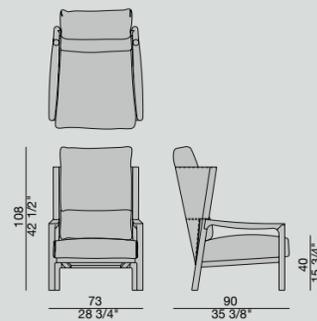

vera bergere

G. & O. Buratti

ESSENZA - WOOD - MADERA

noce canaletta

canaletta walnut
nogal canaletta

METALLO - METAL - METAL

nero opaco

black matt
negro mate

ESSENZA - WOOD - MADERA

noce canaletta

canaletta walnut
nogal canaletta

noce canaletta tinto moka

canaletta walnut moka stained
nogal canaletta teñido moka

noce canaletta tinto wengé

canaletta walnut wengé stained
nogal canaletta teñido wengé

laccato opaco poro chiuso

matt lacquered closed pore
lacado mate poro cerrado

SCHIENALE - BACKREST - RESPALDO

cuoietto

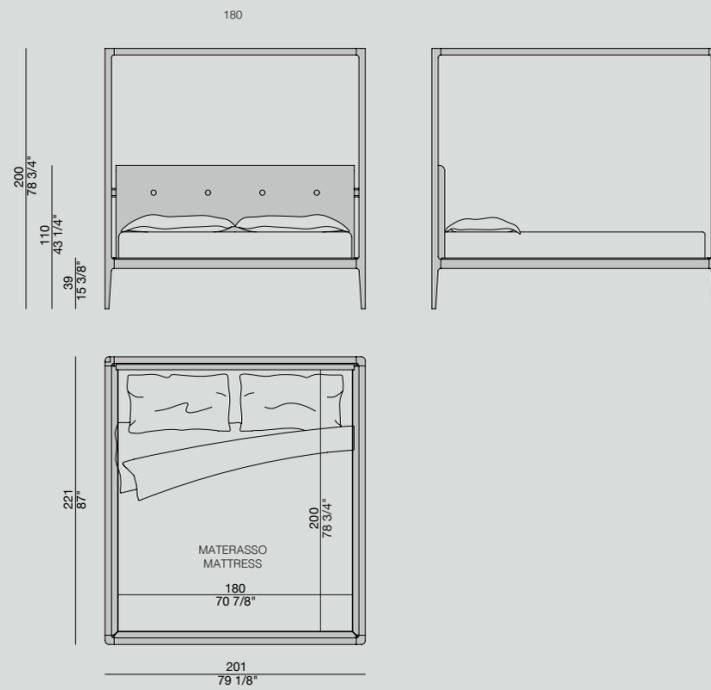

ziggy bed 180 baldacchino

C. Ballabio

ESSENZA - WOOD - MADERA

frassino naturale

natural ash

fresno natural

frassino tinto moka

ash moka stained

fresno teñido moka

frassino tinto noce canaletta

ash canaletta walnut stained

fresno teñido nogal canaletta

frassino tinto wengé

ash wengé stained

fresno teñido wengé

frassino tinto canapa

ash canapa stained

fresno teñido canapa

frassino tinto caffè

ash caffè stained

fresno teñido caffè

laccato opaco poro aperto

matt lacquered open pore

lacado mate poro abierto

materials materiali

Por motivos técnicos no es posible asegurar el mismo tono entre dos entregas diferentes. Los colores representados en las siguientes páginas son indicativos.

Pour des raisons techniques il n'est pas possible de garantir la même couleur d'une livraison à l'autre. Les coloris présentés dans les pages suivantes sont indicatifs.

Aus technischen Gründen können wir bei verschiedenen Lieferungen einen identischen Farbton nicht gewährleisten. Die in den folgenden seiten angegebenen farben können geringfügig von dem Originalton der Farb kollektion abweichen.

Due to technical reasons it is not possible to guarantee the same tone between deliveries. The colours shown in the following pages are only indicative.

Per motivi tecnici non è possibile garantire la stessa tonalità di colore tra una fornitura e l'altra. I colori riprodotti in queste pagine sono indicativi.

ESSENZE - WOOD - MADERA

FRASSINO NATURALE
NATURAL ASH
FRESNO NATURALFRASSINO TINTO NOCE CANALETTA
ASH CANALETTA WALNUT STAINED
FRESNO TENIDO NOGAL CANALETTAFRASSINO TINTO MOKA
ASH MOKA STAINED
FRESNO TENIDO MOKAFRASSINO TINTO CAFFÈ
ASH CAFFÈ STAINED
FRESNO TENIDO CAFFÈFRASSINO TINTO CANAPA
ASH CANAPA STAINED
FRESNO TENIDO CANAPAFRASSINO TINTO WENGÉ
ASH WENGÉ STAINED
FRESNO TENIDO WENGUÉNOCE CANALETTA
CANALETTA WALNUT
NOGAL CANALETTANOCE CANALETTA TINTO MOKA
CANALETTA WALNUT MOKA STAINED
NOGAL CANALETTA TENIDO MOKANOCE CANALETTA TINTO WENGÉ
CANALETTA WALNUT WENGÉ STAINED
NOGAL CANALETTA TENIDO WENGUÉROVERE SPESSART
OAK SPESSART
ROBLE SPESSART

FOGLIA

ARGENTO
SILVER
PLATAORO
GOLDEN
ORO

METALLI - METALS - METAL

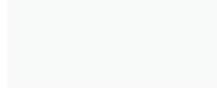
ANTRACITE SPAZZOLATO
BRUSHED ANTHRACITEBIANCO OPACO
WHITE MATT

BRONZORO

CROMATO
CHROME PLATEDCROMO NERO
BLACK CHROMEDGRIGIO PELTRO
GREY PETWËRNERO OPACO
BLACK MATTOTTONE BRONZATO SPAZZOLATO
BRUSHED BRONZE BRASSOTTONE SPAZZOLATO
BRUSHED BRASSRAME
COPPER

SPECCHIO - MIRROR - ESPEJO

NATURALE
CLEARFUMÉ
SMOKED

CRISTALLO - GLASS - CRISTAL

LACCATO BIANCO
WHITE LACQUEREDLACCATO CIOCCOLATO
CHOCOLATE LACQUEREDLACCATO NERO
BLACK LACQUERED

CRISTALLO - GLASS - CRISTAL

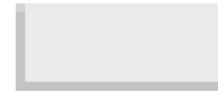
EXTRACHIARO
EXTRALIGHTTRASPARENTE
CLEARFUMÉ
SMOKEDEXTRACHIARO TRASPARENTE ROSA
CLEAR EXTRALIGHT PINKEXTRACHIARO TRASPARENTE ROSSO
CLEAR EXTRALIGHT RED

CRISTALLO - GLASS - CRISTAL

acidato - frosted - al ácido

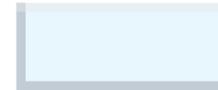
EXTRACHIARO
EXTRALIGHTEXTRACHIARO LACCATO BIANCO
EXTRALIGHT WHITE LACQUEREDLACCATO NERO
BLACK LACQUEREDEXTRACHIARO LACCATO ARGILLA
EXTRALIGHT ARGILLA LACQUEREDEXTRACHIARO LACCATO GRANATA
EXTRALIGHT GRANATA LACQUEREDEXTRACHIARO LACCATO PISTACCHIO
EXTRALIGHT PISTACCHIO LACQUEREDEXTRACHIARO LACCATO AVIO
EXTRALIGHT AVIO LACQUEREDEXTRACHIARO LACCATO IRON
EXTRALIGHT IRON LACQUERED

LACCATI - LAQUERED - LACADO

brillante - shiny - brillo

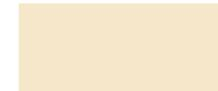
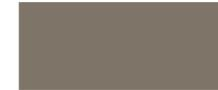
BIANCO BRILLANTE
WHITE SHINY LACQUERED
LACADO BRILLO BLANCOAVORIO BRILLANTE
IVORY SHINY LACQUERED
LACADO BRILLO MARFILCIOCCOLATO BRILLANTE
CHOCOLATE SHINY LACQUERED
LACADO BRILLO CHOCOLATENERO BRILLANTE
BLACK SHINY LACQUERED
LACADO BRILLO NEGRO

ARGILLA RAL 7006



PIOMBO NCS S 5005 G20Y



GRANATA NCS S 4050 Y90R



PISTACCHIO



AVIO



IRON

LACCATI - LAQUERED - LACADO

poro aperto - open pore - poro abierto

BIANCO 9016
WHITE - BLANCOAVORIO 1013
IVORY - MARFILCIOCCOLATO 8019
CHOCOLATE - CHOCOLATENERO 9005
BLACK - NEGRO

ARGILLA RAL 7006



PIOMBO NCS S 5005 G20Y



GRANATA NCS S 4050 Y90R



PISTACCHIO



AVIO



IRON

LACCATI - LAQUERED - LACADO

poro chiuso - closed pore - poro cerrado

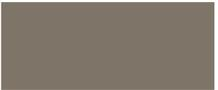
BIANCO 9016
WHITE - BLANCOAVORIO 1013
IVORY - MARFILCIOCCOLATO 8019
CHOCOLATE - CHOCOLATENERO 9005
BLACK - NEGRO

ARGILLA RAL 7006



PIOMBO NCS S 5005 G20Y



GRANATA NCS S 4050 Y90R



PISTACCHIO



AVIO



IRON

NABUK



2136



2107



2103



2114



2130



2101



2115



2118



2117



2133



2108



2116

PELLE PLUS



C09



C14



C17



C18



C25



C26



C28



C29



C30



C31



C33



C35



C38



C40



C45



C46



C47



C48



C49



C51



C53



C56



C57



C58



C61



C64



C68



C69

PELLE EXTRA



L655



L657



L1631



L621



L601



L603



L619



L1131



L1647



L1626



L646



L1147



L648



L623



L643



L644



L653



L650



L635



L604



L628



L1607



L629



L1627



L1187



L1216



L660



L622

PELLE



D93



D26



D43



D70



D28



D85



D21



D75



D80



D95



D50



D89



D16



D31



D51



D63



D62



D33



D79



D87



D71



D13



D61



D92



D24



D74

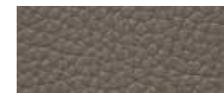

D17



D10

CUOINETTO



BIANCO 04



NERO 02



FOCA 08



GRIGIO SCURO 03



CORDA 07



SABBIA 05



NATURALE 06



INVECCHIATO 26



TESTA DI MORO 19



ROSSO BULGARO 01

CUOIO



BIANCO 04



NERO 02



FOCA 36



GRIGIO SCURO 03



CORDA 08



SABBIA 07



NATURALE 06



INVECCHIATO 26



TESTA DI MORO 27



ROSSO BULGARO 01

HALLINGDAL 65

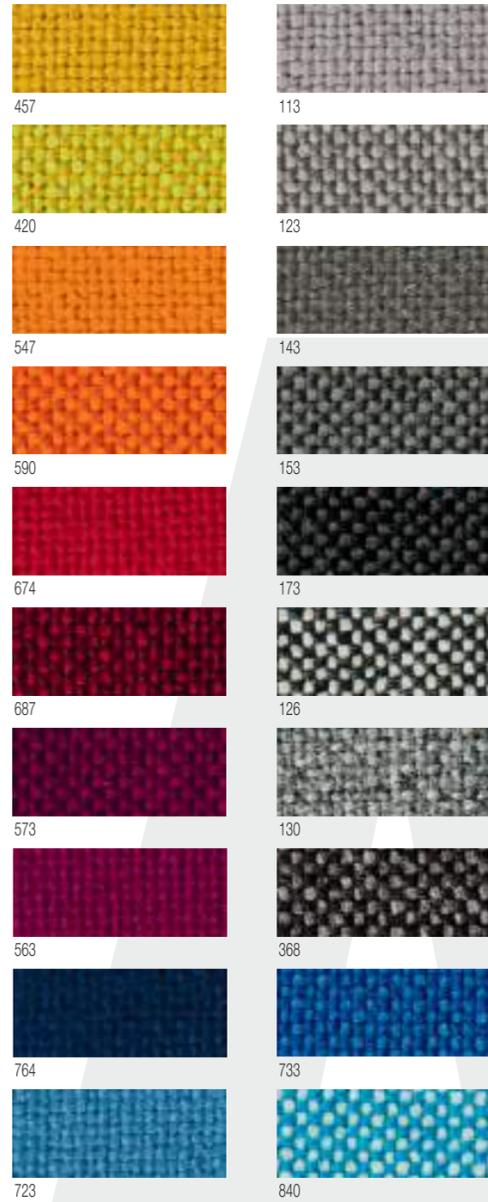

cat. A
 lana vergine - new wool 70%
 viscosa - viscose 30%



HOUND

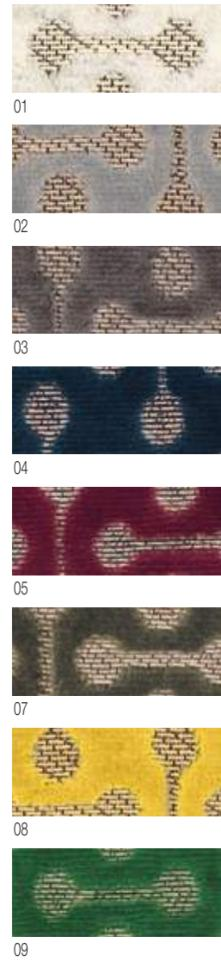

cat. A
COMP:
 cotone - cotton 59%
 pl 30%
 pc 6%
 viscosa - viscose 3%
 pa 1%
 af 1%
FONDO/GROUND:
 pl 43%
 cotone - cotton 41%
 pc 8%
 viscosa - viscose 4%
 pa 2%
 af 2%
PELO/PILE:
 cotone - cotton 100%



MILORD



cat. B
 poliammide - polyamide 63%
 cotone - cotton 37%



RABAT
L1454



L1454/10



L1454/05



L1454/02



L1454/06

L1571



L1571/99



L1571/93



L1571/50



L1571/59

11524



11524/02



11524/3



11524/04



11524/5



11524/06



11524/09



11524/10



11524/14



11524/16



11524/17



11524/18



11524/24

12823



12823/37



12823/20



12823/40



12823/44



12823/36

cat. **B**

viscosa - viscose	64%
pl	15%
cotone - cotton	11%
lino - linen	10%



lino - linen	30%
cotone - cotton	39%
viscosa - viscose	23%
pl	4%
pa	4%



cotone - cotton	44%
pl	22%
pc	21%
viscosa - viscose	13%



viscosa - viscose	48%
pc	32%
pl	20%



ARMAM



L1569 01



L1569 02



L1569 03



L1569 04



L1569 05



L1569 06



L1569 07



L1569 09



L1569 11



L1569 13



L1569 14

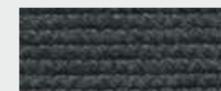

L1569 16



L1569 17



L1569 19

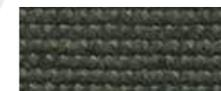

L1569 20



L1569 21

cat. **C**

viscosa - viscose	39%
cotone - cotton	35%
poliammide - polyamide	16%
lino - linen	10%



FASHION



02 ANGIE



03 ANGIE



04 ANGIE



06 ANGIE



02 FREE



03 FREE



04 FREE

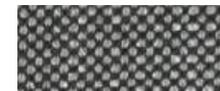

06 FREE



02 BOSS



03 BOSS



06 BOSS



02 JOY



03 JOY



04 JOY



06 JOY

cat. **C**

viscosa - viscose	44%
cotone - cotton	34%
lino - linen	22%



FLAX



cat. **C**
juta - jute 54%
lino - linen 46%



IKAT



cat. **C**
poliammide - polyamide 75%
cotone - cotton 16%
acrilico - acrylic 9%
viscosa - viscose 51%
cotone - cotton 23%
poliammide - polyamide 16%
lino - linen 10%



MADRAS

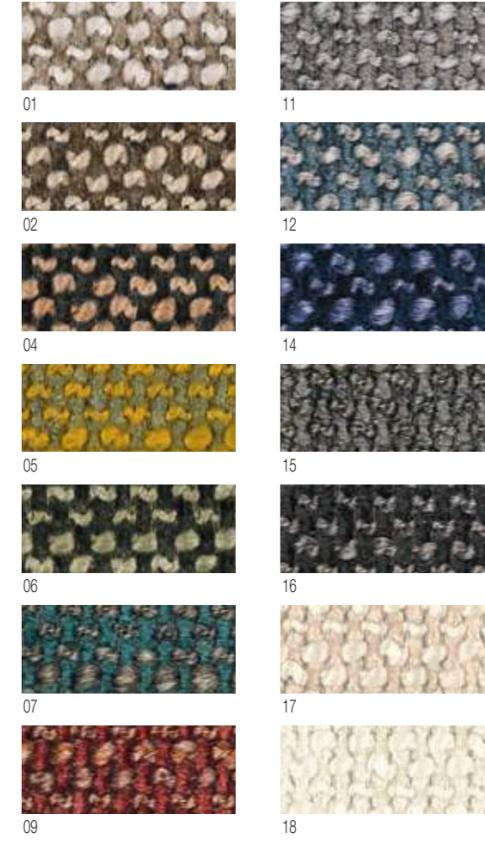

cat. **C**
cotone - cotton 30%
pc 29%
pl 26%
viscosa - viscose 15%



LOOM



cat. **C**
viscosa - viscose 52%
cotone - cotton 25%
poliammide - polyamide 11%
lino - linen 12%



MORAN



cat. **C**
viscosa - viscose 50%
cotone - cotton 30%
poliestere - polyester 20%



THALYS



cat. **C**
 cotone - cotton 41%
 viscosa - viscose 35%
 poliestere - polyester 14%
 lino - linen 10%



VELVET



cat. **C**
 cotone - cotton 100%



WOOL



cat. **C**
 lana - wool 65%
 alpaca - alpaca 15%
 poliammide - polyamide 20%
 tessuto ignifugo - fire-retardant fabric



ASTRA

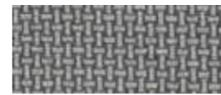

605

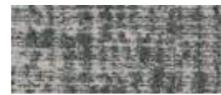

505



602



502



603



503



604

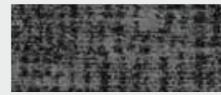

504



606



506



607



507



608



508



601



501

cat. **D**
 poliestere - polyester 45%
 acrilico - acrylic 35%
 lana - wool 20%



ECOPELLE - SYNTHETIC LEATHER - ECOPIEL

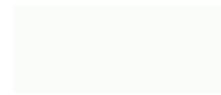

150



2350



250



750



350



850



1150



1050



450



1250



2050



1350



2450



1950



1550



1850



2850



2150



2750



2250

cat. **D**
 poliuretano - polyurethane 63%
 cotone - cotton 37%

RANGE



04



28



36



07



29



40



08



30



10



31



11



32



12



33



25

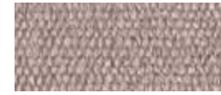

35

cat. **D**
 cotone - cotton 56%
 viscosa - viscose 24%
 lino - linen 20%



TRESS



900



902



100



101



802



803



804



805



806



500



604



602

cat. **D**
 poliestere - polyester 84%
 acrilico - acrylic 16%



COTONE



cat. **E**
 cotone - cotton 100%
 tessuto ignifugo - fire-retardant fabric



DORIAN

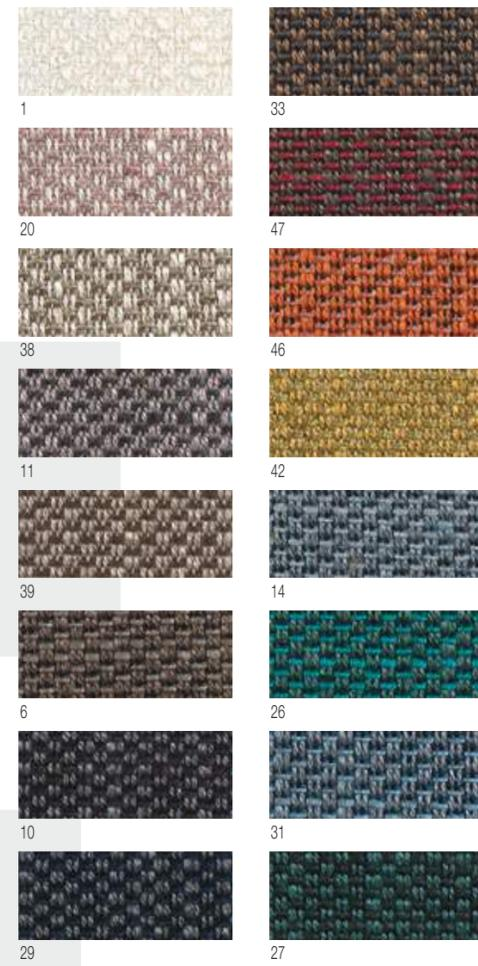

cat. **E**
 viscosa - viscose 40%
 poliacrilico - polyacrylic 20%
 lino - linen 20%
 cotone - cotton 20%



ZENITH PROFILO / PIPING

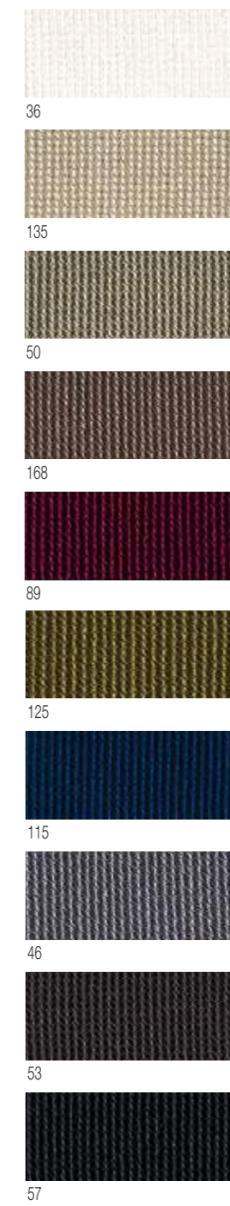

cotone - cotton 60%
 acrilico - acrylic 40%

MARMO - MARBLE - MARMOL



BIANCO CALACATTA ORO - WHITE CALACATTA GOLD - BLANCO CALACATTA ORO

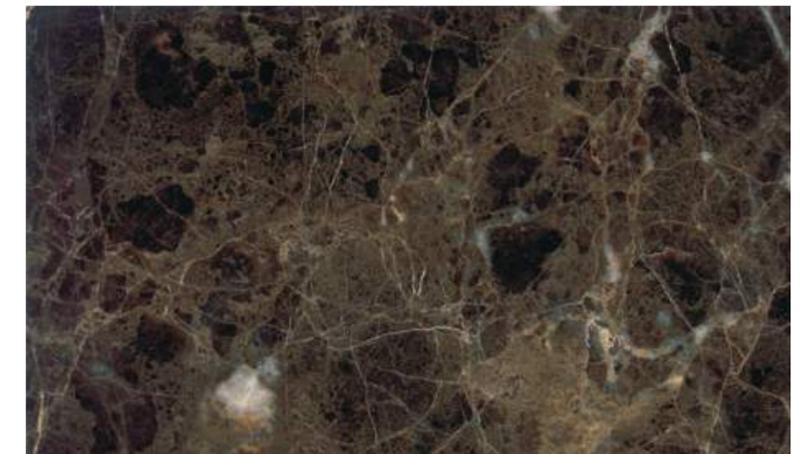

MARRONE EMPERADOR DARK - BROWN EMPERADOR DARK - MARRÓN EMPERADOR DARK

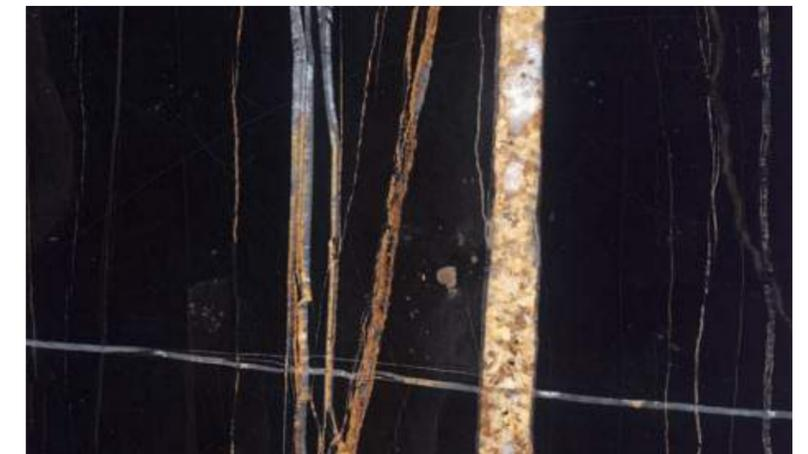

SAHARA NOIR

ROCK**MATT OXIDE BLACK**

PORCELLANA LAMINATA OTTENUTA PER MACINAZIONE AD UMIDO DI MATERIE PRIME ARGILLOSE, ROCCE GRANITICHE E METAMORFICHE, A COMPONENTE FELDSPATICA E PIGMENTI CERAMICI. COMPATTATA DA SPECIALE FORMATURA IN COMPATTE E SINTERIZZAZIONE A 1200°C, CON COTTURA A GAS. ROCK RESISTE AL CONTATTO PROLUNGATO CON LE PRINCIPALI MACCHIE OSTINATE PRESENTI IN CUCINA QUALI VINO, CAFFÈ, OLIO D'OLIVA, LIMONE, SENZA ALTERAZIONI PERMANENTI DI COLORE O BRILLANTEZZA.

LAMINATED PORCELAIN OBTAINED BY WET-GRINDING CLAY, GRANITE AND METAMORPHIC ROCK RAW MATERIALS TOGETHER WITH A FELDSPAR COMPONENT AND CERAMIC PIGMENTS. SPECIALLY SHAPED IN A COMPACTOR AND SINTERED AT 1200°C, WITH GAS FIRING. ROCK IS NOT AFFECTED BY PROLONGED CONTACT WITH PRODUCTS COMMONLY FOUND IN THE KITCHEN THAT CAN CAUSE STAINING, SUCH AS WINE, COFFEE, OLIVE OIL OR LEMON JUICE, AND ITS COLOUR OR SHINE WILL NOT BE AFFECTED PERMANENTLY.

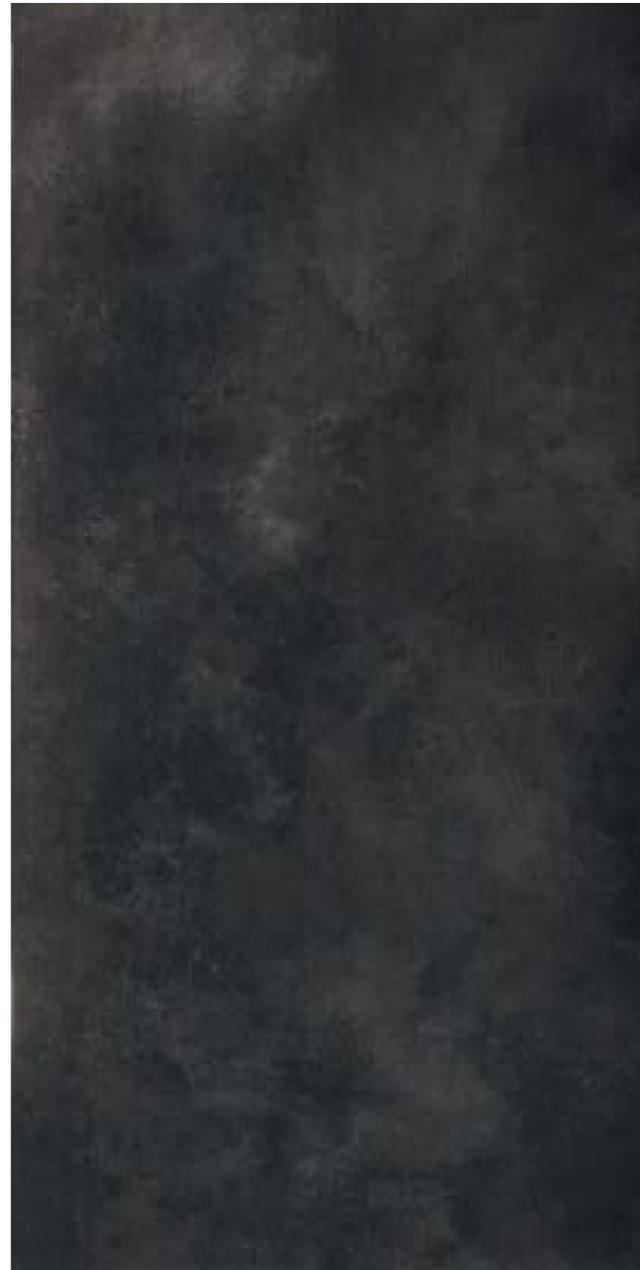

324X162 CM.

RIPRESA GRAFICA DELLA LASTRA INTERA DA NOI UTILIZZATA.
IMAGE OF THE WHOLE SHEET WE USE.

MATT CALACATTA

FA



324X162 CM.

RIPRESA GRAFICHE DELLE LASTRE INTERE DA NOI UTILIZZATE. NON È POSSIBILE LA SELEZIONE DELLA LASTRA DA PARTE DEL CLIENTE.
IMAGE OF THE WHOLE SHEET WE USE. CUSTOMER CAN NOT SELECT THE SHEET TO BE USED.

FB



MATT EMPERADOR

FA



FB



FC



324X162 CM.

RIPRESE GRAFICHE DELLE LASTRE INTERE DA NOI UTILIZZATE.
NON È POSSIBILE LA SELEZIONE DELLA LASTRA DA PARTE DEL CLIENTE.
IMAGE OF THE WHOLE SHEET WE USE.
CUSTOMER CAN NOT SELECT THE SHEET TO BE USED.

GRAPHIC DESIGNER:
MASSIMO ABBONDI

PHOTOGRAPHER:
DAVIDE CERATI

COORDINATION,
CONCEPT AND STYLING:
PAOLA CITTERIO

PRINTING:
CHINCHIO
INDUSTRIA GRAFICA SRL

LONDON SHOWROOM:
FIRST FLOOR,
SOUTH DOME
DESIGN CENTRE
CHELSEA HARBOUR
LONDON - SW10 0XE
PH: 020 3155 3065
ENQUIRIESUK@PORADA.IT

MILANO SHOWROOM :
20121 MILANO
(MI) ITALIA
VIA BORGOSPESSE, 18
TEL. +39 02 49700 896
MILANO@PORADA.IT

22060 CABIATE
(COMO) ITALIA
VIA B. BUZZI, 2
TEL. +39 031 766215
INFO@PORADA.IT

WWW.PORADA.IT

LONDON SHOWROOM:
FIRST FLOOR,
SOUTH DOME
DESIGN CENTRE
CHELSEA HARBOUR
LONDON - SW10 0XE
PH: 020 3155 3065
ENQUIRIESUK@PORADA.IT

MILANO SHOWROOM :
20121 MILANO
(MI) ITALIA
VIA BORGOSPESSE, 18
TEL. +39 02 49700 896
MILANO@PORADA.IT

22060 CABIATE
(COMO) ITALIA
VIA B. BUOZZI, 2
TEL. +39 031 766215
INFO@PORADA.IT

WWW.PORADA.IT