

alberta[®]
Made in Italy



PREVIEW BOOK 03



Black è eleganza, fascino, forza.

Alberta sceglie un simbolo di raffinatezza e stile indiscusso per rappresentare la forza della sua nuova collezione. Linee geometriche e volumi accoglienti diventano un segno distintivo dell'azienda, sempre pronta a rinnovarsi per interpretare al meglio lo stile dell'abitazione contemporanea. Tessuti, finiture, colori sono selezionati ed accostati con cura e sapienza sartoriale, per creare prodotti unici ed esclusivi, capaci di "disegnare" lo spazio in cui sono inseriti con personalità ed un pizzico di ironia.



Black is elegance, fascination, strength.

Alberta chooses a symbol of undisputed sophistication and style to express the strength of the new collection. The geometric lines and enveloping shapes become a trademark for the company, always ready to innovate to better express modern living styles. Fabrics, finishes, colours are all carefully and expertly selected and matched to create unique, exclusive products that "design" the interiors with all their personality and a touch of irony.



Black c'est l'élégance, le charme, la force.

Alberta choisit un symbole de raffinement et de style incontesté pour représenter la force de sa nouvelle collection. Les lignes géométriques et les volumes accueillants deviennent un signe distinctif de l'entreprise, toujours prête à se renouveler pour interpréter au mieux le style de l'habitat contemporain. Les tissus, les finitions et les couleurs sont sélectionnés et associés avec soin et un savoir-faire artisanal, pour créer des produits uniques et exclusifs, en mesure de « dessiner » l'espace dans lequel ils sont intégrés avec personnalité et une pincée d'ironie.



Black ist Eleganz, Charme, Stärke.

Alberta entscheidet sich für ein Symbol der Eleganz und für unbestrittenen Stil, um die Stärke der neuen Kollektion zu zeigen. Die geometrischen Linien und behaglichen Formen werden so zu einem Erkennungszeichen der Firma, die jederzeit bereit ist, neue Wege einzuschlagen und den Stil modernen Wohnens gekonnt zu interpretieren. Stoffe, Oberflächen und Farben werden mit großer Sorgfalt und Schneiderkunst ausgewählt und für einzigartige und exklusive Möbel kombiniert. Möbel, die in der Lage sind, den Raum, in dem sie stehen, mit Persönlichkeit und einem kleinen Augenzwinkern zu "designen".

alberta

INDICE • INDEX

DIVANI • SOFAS.....	9
RIEPILOGO • SUMMARY.....	89
FINITURE • FINISHING.....	99
DATI TECNICI • TECHNICAL DATA.....	104

DIVANI • SOFAS



FLYNN 10



FEENIX 26



FREEDOM 44



VALERY 64

POLTRONE • ARMCHAIRS



CECILE 20, 59, 61, 62, 63



HONOLULU 28, 47, 48, 49



SWEET JANE 13, 15, 17, 18, 22, 80, 82, 85



JAMMIN LARGE 35

DIVANI • SOFAS



FLYNN

Design by Maurizio Manzoni

















FEENIX

Design by Maurizio Manzoni



















FREEEDOM

Design by Alberta Style Department





















VALERY

Design by Maurizio Manzoni

























RIEPILOGO • SUMMARY



FLYNN



12

FLYNN divano/sofa/canapé/Sofa
 • 01FLYC27 (1FLYD2SS1SX+1FLYPFFR+1FLYD3DX) • 6B14 Sussurro Platino, Cat. 6 • piede/foot/pied/Fuß Gun Metal
 SWEET JANE poltrona/armchair/fauteuil/Sessel
 • 2SWJP • 9N9 Ascott Black, Cat. G • gambe/legs/jambes/Beine Glossy Browned
 ORIGAMI LUXURY GLASS tavolino/small table/table/Couchtisch
 • 1OL5TAV50 • Top vetro gofrato/embossed glass / Verre gaufré /Vorgespanntem Pressglas • struttura/structure/Struktur French Bronze
 FLYNN 4 TABLE tavolino/small table/table/Couchtisch ø 110
 • 1FL4TROT110 • Top ceramica/ Ceramic/Céramique/ Keramik • struttura/structure/Struktur Gun Metal
 FLYNN 4 TABLE tavolino/small table/table/Couchtisch ø 80
 • 1FL4TROT80 • Top ceramica/ Ceramic/Céramique/ Keramik • struttura/structure/Struktur Gun Metal
 FLYNN 4 TABLE tavolino/small table/table/Couchtisch ø 60
 • 1FL4TROT60 • Top ceramica/ Ceramic/Céramique/ Keramik • struttura/structure/Struktur Gun Metal

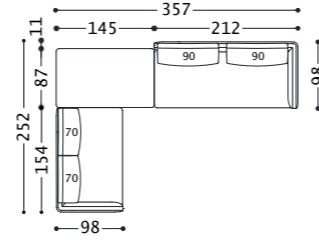

14

SWEET JANE poltrona/armchair/fauteuil/Sessel
 • 2SWJP • 9N9 Ascott Black, Cat. G • gambe/legs/jambes/Beine Glossy Browned
 ORIGAMI LUXURY GLASS tavolino/small table/table/Couchtisch
 • 1OL5TAV50 • Top vetro gofrato/embossed glass/Verre gaufré/ Vorgespanntem Pressglas • struttura/structure/Struktur French Bronze

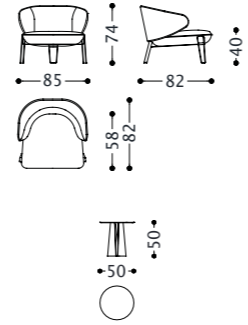

15



16

FLYNN divano/sofa/canapé/Sofa
 • 01FLYC4 (1FLYD3SX+1FLYDORMDX) • 5C44 Eloise 620 perla, Cat. 5 • piede/foot/pied/Fuß Glossy Browned
 SWEET JANE poltrona/armchair/fauteuil/Sessel
 • 1SWJP • 7471 Kos 01 Ecu, Cat. 7 • gambe/legs/jambes/Beine Glossy Browned
 JIMMY 3 tavolino/small table/table/Couchtisch 55X55
 • 1JI3TAVQ55H • Top Ivory • struttura/structure/Struktur Gun Metal
 FLYNN 5 TABLE tavolino/small table/table/Couchtisch ø 110
 • 1FL5TROT110 • Top vetro fumè/fumé glass/verre fumé/Rauchglas • struttura/structure/Struktur Gun Metal
 FLYNN 4 TABLE tavolino/small table/table/Couchtisch ø 80
 • 1FL4TROT80 • Top ceramica/ Ceramic/Céramique/ Keramik • struttura/structure/Struktur Gun Metal
 FLYNN 4 TABLE tavolino/small table/table/Couchtisch ø 60
 • 1FL4TROT60 • Top ceramica/Ceramic/Céramique/ Keramik • struttura/structure/Struktur Gun Metal

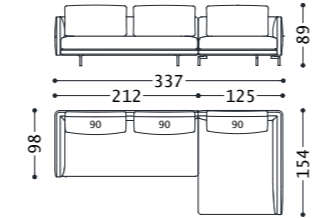

17



20

FLYNN divano/sofa/canapé/Sofa
 • 03FLYC24 (1FLYD3MSX+1FLYPFFQ+1FLYTR3STDx+1FYTTAV)
 • 1FLYD3MSX+1FLYPFFQ+1FLYTR3STDx • 6524 Romuald Creta, Cat. 6 • piede/foot/pied/Fuß Glossy Browned • 1FYTTAV marmo/marble/marbre/Marmor Calacatta White, Cat. X4
 CECILE poltrona/armchair/fauteuil/Sessel
 • 1CECPNC • 7472 Kos 55 Cacao, Cat. 7 • Struttura/structure/Struktur Noce Canaletto, Gun Metal
 FRISCO tavolino/small table/table/Couchtisch 120x120
 • 1FRITAVQB • Top 1 marmo/marble/marbre/Marmor Calacatta White, Cat. X4 • Top 2 Dove grey • struttura/structure/structure/Struktur Gun Metal
 JIMMY 3 tavolino/small table/table/Couchtisch 55X55
 • 1JI3TAVQ55H • Top Ivory • struttura/structure/Struktur Gun Metal
 JIMMY 3 consolle/console/Konsole 160x40
 • 1JI3CO160 • Top Dove grey • struttura/structure/Struktur French bronze

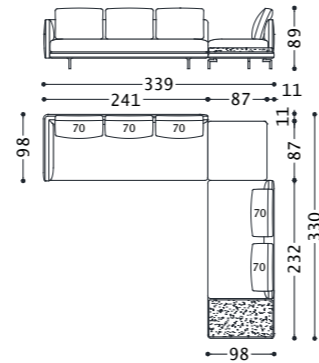

21



22

FLYNN divano/sofa/canapé/Sofa
 • 01FLYC28 (1FLYD3SX+1FLYPFFR+1FLYD2SS1DX) • 6B14 Sussurro Platino, Cat. 6 • piede/foot/pied/Fuß Gun Metal
 SWEET JANE poltrona/armchair/fauteuil/Sessel
 • 2SWJP • 9N9 Ascott Black, Cat. G • gambe/legs/jambes/Beine Glossy Browned
 ORIGAMI LUXURY GLASS tavolino/small table/table/Couchtisch
 • 1OL5TAV50 • Top vetro gofrato/embossed glass / Verre gaufré /Vorgespanntem Pressglas • struttura/structure/Struktur French Bronze
 FLYNN 4 TABLE tavolino/small table/table/Couchtisch ø 110
 • 1FL4TROT110 • Top ceramica/ Ceramic/Céramique/ Keramik • struttura/structure/Struktur Gun Metal
 FLYNN 4 TABLE tavolino/small table/table/Couchtisch ø 80
 • 1FL4TROT80 • Top ceramica/ Ceramic/Céramique/ Keramik • struttura/structure/Struktur Gun Metal
 FLYNN 4 TABLE tavolino/small table/table/Couchtisch ø 60
 • 1FL4TROT60 • Top ceramica/ Ceramic/Céramique/ Keramik • struttura/structure/Struktur Gun Metal

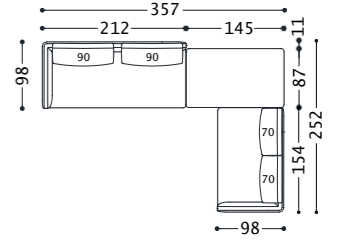

23

FEENIX



28

29

FEENIX divano/sofa/canapé/Sofa
 • 02FEEC6 (2FEED3MSX+2FEEP1+2FEEMERDX) • 954 Fjord Sand, Cat. G • staffa/stirrup/étrier/Bügel Gun metal
HONOLULU poltrona relax/relax armchair/fauteuil relax/Sessel relax
 • 02HONC3 (2HONPAGNONV-2HONPOUFFNONV) • 9N5 Ascott Fango, Cat. G • Struttura esterna/surface/structure exterieur/Aussere Struktur Noce/Walnut/noyer/Nußbaum • basamento/base/piétement/Basis nero verniciato/varnished black/noir verni/Schwarz lackiert
FLYNN 4 TABLE tavolino/small table/table/Couchtisch 130x80
 • 1FL4TAVR • Top ceramica/Ceramic/Céramique/Keramik • struttura/structure/Struktur Gun Metal
FLYNN 4 TABLE tavolino/small table/table/Couchtisch ø 60
 • 1FL4TROT60 • Top ceramica/Ceramic/Céramique/Keramik • struttura/structure/Struktur Gun Metal

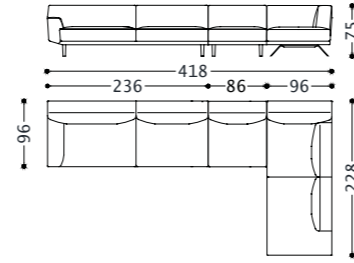

42

43

FEENIX divano/sofa/canapé/Sofa
 • 2FEED3M • 9C7 Sensation camel, Cat. H • staffa/stirrup/étrier/Bügel Gun metal

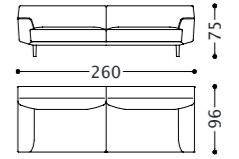

32

33

FEENIX divano/sofa/canapé/Sofa
 • 02FEEC6 (2FEED3MSX+2FEEP1+2FEEMERDX) • 954 Fjord Sand, Cat. G • staffa/stirrup/étrier/Bügel Gun metal
FLYNN 4 TABLE tavolino/small table/table/Couchtisch 130x80
 • 1FL4TAVR • Top ceramica/Ceramic/Céramique/Keramik • struttura/structure/Struktur Gun Metal

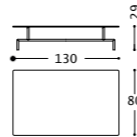
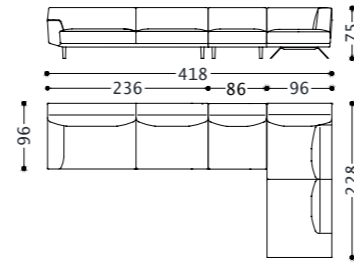

34

35

FEENIX divano/sofa/canapé/Sofa
 • 1FEED3M • 8370 Zincy 76 polvere, Cat. 8 • staffa/stirrup/étrier/Bügel Gun metal
JAMMIN LARGE poltrona girevole/swivel armchair/fauteuil tournant/Drehsessel
 • 2JAMPLG • 942 Fjord Dark Brown, Cat. G • basamento/base/piétement/Basis Gun Metal
99 pouff/pouf/Hocker
 • 299PFFV • 942 Fjord Dark Brown, Cat. G
ISLAND tavolino/small table/table/Couchtisch
 • 1ISNTMTS23 • 1ISNTLT40 • Top Noce Canaletto • struttura/structure/Struktur Gun Metal
FRISCO tavolino/small table/table/Couchtisch ø 50
 • 1FRITROT • Top 1 marmo/marble/marbre/Marmor Magic brown, Cat. X1 • Top 2 Mink brown • struttura/structure/structure/Struktur French Bronze
JAGGER tavolino/small table/table/Couchtisch ø50
 • 1JAGTL • Mink Brown

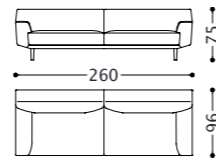

38

39

FEENIX divano/sofa/canapé/Sofa
 • 01FEEC1 (1FEEDORMSX+1FEED3MDX) • 6955 Sfalari sabbia, Cat. 6 • staffa/stirrup/étrier/Bügel Gun metal
FEENIX 1 TABLE tavolino/small table/table/Couchtisch 154x76
 • 1FE1TAVR • Top MDF impiallacciato eucalipto frisè e marmo Cream calacatta, Cat. X4/Top: veneer MDF eucalyptus frisè and marble Cream calacatta, Cat. X4/Plateau: MDF placage eucalyptus frisè et marbre Cream calacatta, Cat. X4/Top: Holz Eukalyptus Frisé und Marmor Cream calacatta, Cat. X4 • struttura/structure/Struktur Gun metal

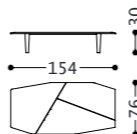
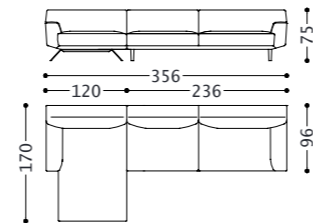

FREEDOM



46

47

FREEDOM composizione/composition/Komposition
 • 2FREEA200+2FREEC • 9C5 Sensation Avio, Cat. H
 • 1FRESCH5 + 1FRESCH3 (nr.2) • 7657 Arco Tempesta, Cat. 7
 • 1FREBR + 1FRECGC (nr.2) + 1FRECSS (nr.2) • 6C11 Calafee 25 Malachite, Cat. 6 • piede/foot/pied/Fuße Gun Metal
HONOLULU poltrona relax/relax armchair/fauteuil relax/Sessel relax
 • 02HONC3 (2HONPAGNONV+2HONPOUFFNONV) • 9N5 Ascott Fango, Cat. G • Struttura esterna/surface/structure exterieur/Aussere Struktur Noce/Walnut/noyer/Nußbaum • basamento/base/piétement/Basis nero verniciato/varnished black/noir verni/Schwarz lackiert
FLYNN 4 TABLE tavolino/small table/table/Couchtisch ø 110
 • 1FL4TROT110 • Top ceramica/Ceramic/Céramique/Keramik • struttura/structure/Struktur Gun Metal
FLYNN 4 TABLE tavolino/small table/table/Couchtisch ø 80
 • 1FL4TROT80 • Top ceramica/Ceramic/Céramique/Keramik • struttura/structure/Struktur Gun Metal
FLYNN 4 TABLE tavolino/small table/table/Couchtisch ø 60
 • 1FL4TROT60 • Top ceramica/Ceramic/Céramique/Keramik • struttura/structure/Struktur Gun Metal

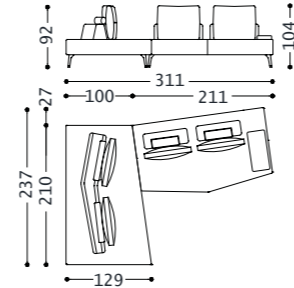

50

51



54

55

FREEDOM composizione/composition/Komposition
 • 01FREC19 (1FREEC+1FREEG+1FREEA220+1FRESCH5 (nr.2)+1FRECG (nr.4)) • 6C15 Cafalee 26 Sabbia, Cat. 6 • piede/foot/pied/Fuße Gun Metal
FREEDOM composizione/composition/Komposition
 • 01FREC18 (1FREEB+1FRESCH3+1FRECGC) • 6C15 Cafalee 26 Sabbia, Cat. 6 • piede/foot/pied/Fuße Gun Metal
JIMMY 3 tavolino/small table/table/Couchtisch 150X90
 • 1JI3TAVRM • Top Dark brown • struttura/structure/Struktur Gun Metal
JIMMY 3 tavolino/small table/table/Couchtisch 75X75
 • 1JI3TAVQ75H • Top Mist • struttura/structure/Struktur Gun Metal
JIMMY 3 consolle/console/Konsole 160x40
 • 1JI3CO160 • Top Ivory • struttura/structure/Struktur Gun Metal
PHIL tavolino/small table/table/Couchtisch
 • 1PHISER • marmo/marble/marbre/Marmor Cream Calacatta, Cat. X4 • struttura/structure/structure/Struktur Gun Metal

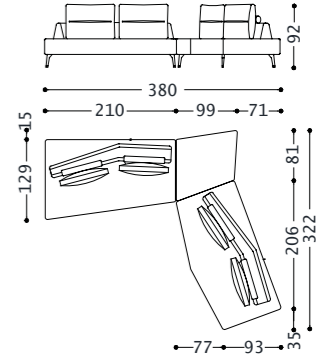

56

57

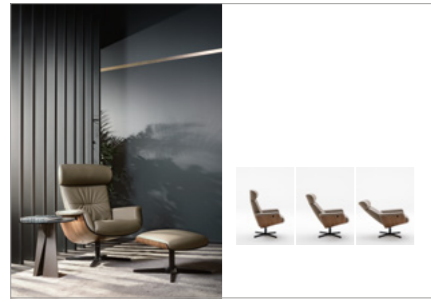
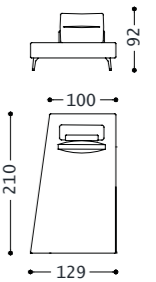

48

49

HONOLULU poltrona relax/relax armchair/fauteuil relax/Sessel relax
 • 02HONC3 (2HONPAGNONV+2HONPOUFFNONV) • 9N5 Ascott Fango, Cat. G • Struttura esterna/surface/structure exterieur/Aussere Struktur Noce/Walnut/noyer/Nußbaum • basamento/base/piétement/Basis nero verniciato/varnished black/noir verni/Schwarz lackiert

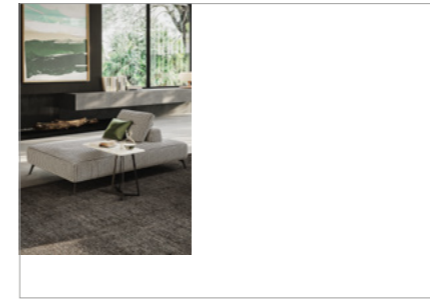
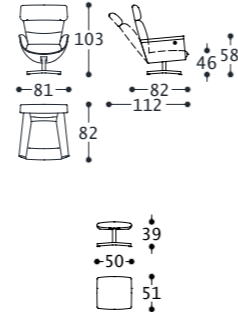

58

FREEDOM composizione/composition/Komposition
 • 01FREC18 (1FREEB+1FRESCH3+1FRECGC)
 • 7902 PDP Small B.co/Nero, Cat. 7 • piede/foot/pied/Fuße Gun Metal
PHIL tavolino/small table/table/Couchtisch
 • 1PHISER • marmo/marble/marbre/Marmor Cream Calacatta, Cat. X4 • struttura/structure/structure/Struktur Gun Metal

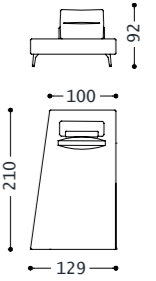

62

63

CECILE poltrona/armchair/fauteuil/Sessel
 • 2CECPW • 942 Fjord Dark brown, Cat. G • Struttura/structure/Struktur Dark Oak, Gun Metal
FRISCO tavolino/small table/table/Couchtisch ø 50
 • 1FRITROT • Top 1 marmo/marble/marbre/Marmor Calacatta white, Cat. X4 • Top 2 Dove Grey • struttura/structure/structure/Struktur Gun Metal

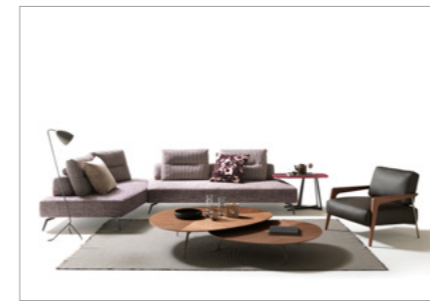
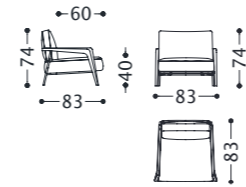

60

61

FREEDOM composizione/composition/Komposition
 • 01FREC16 (1FREEA200+1FREEB+1FRESCH3 (nr.2)+1FRESCH4+1FRECGC (nr. 4)
 • 1FREEA200+1FREEB+1FRESCH3 (nr.2)+1FRESCH4 • 6C03 Champ 12 Melanzana, Cat. 6 • piede/foot/pied/Fuße French Bronze
 • 1FRECGC (nr. 4) • 7903 PDP Small Melanzana, Cat. 7
CECILE poltrona/armchair/fauteuil/Sessel
 • 2CECPNC • 942 Fjord Dark brown, Cat. G • Struttura/structure/Struktur Noce Canaletto, French Bronze
ISLAND tavolino/small table/table/Couchtisch
 • 1ISNTMT30 • 1ISNTLT40 • Top Noce Canaletto • struttura/structure/Struktur French Bronze
JIMMY 3 tavolino/small table/table/Couchtisch
 • 1JI3SER • Top Burgundy • struttura/structure/Struktur Gun Metal

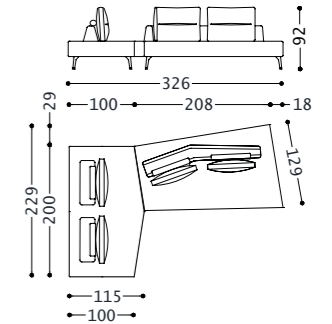

VALERY



66

- VALERY** divano/sofa/canapé/Sofa
 • 01VLRC31 (1VLRD3MSX+1VLRPFRR+1VLRTR2DX) • 8336 Gala 0702 moro, Cat. 8 • staffa/stirrup/étrier/Bügel Glossy Browned
VALERY day bed small
 • 2VLRDBS • 942 Fjord Dark Brown, Cat. G • staffa/stirrup/étrier/Bügel Glossy Browned
VERONIQUE 1 madia alta/high cupboard/buffet haut/hoher Schrank
 • 1VE1MAA • Top marmo/marble/marbre/Marmor Calacatta White, Cat. X4 • base/Basis: eucalipto frisé e laccato opaco colore "snow"/eucalyptus frisé and matt lacquered colour "snow"/eucalyptus frisé et laqué opaque couleur "snow"/Eukalyptus Frisé und matt lackiert Farbe "Snow" • struttura/structure/Struktur Glossy Browned
VALERY 1 TABLE tavolino/small table/table/Couchtisch 133x139
 • 1VL1TAV1 • Top marmo/marble/marbre/Marmor Calacatta White, Cat. X4 • struttura/structure/structure/Struktur Glossy Browned
VALERY 1 TABLE consolle/console/console/Konsole
 • 1VLRCONDX • Top 1 marmo/marble/marbre/Marmor Calacatta White, Cat. X4 • top 2 vetro gofrato/embossed glass/verre gaufré/Pressglas • struttura/structure/structure/Struktur Glossy Browned

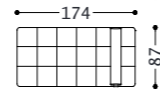
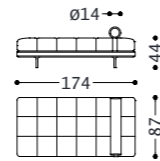
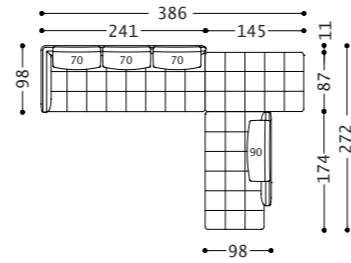

67



80

- VALERY** divano/sofa/canapé/Sofa
 • 01VLRC1 (1VLRD3MSX+1VLRPFRR+1VLRTR2DX+VLRDORMDX)
 • 8338 Gala col. 5667 Avio, Cat. 8 • staffa/stirrup/étrier/Bügel Glossy Browned
SWEET JANE poltrona/armchair/fauteuil/Sessel
 • 1SWJP • C008 Delice 11 Oceano, Cat. 12 • gambe/legs/jambes/Beine Glossy Browned
VERONIQUE 1 madia alta/high cupboard/buffet haut/hoher Schrank
 • 1VE1MAA • Top marmo/marble/marbre/Marmor Calacatta White, Cat. X4 • base/Basis: eucalipto frisé e laccato opaco colore "snow"/eucalyptus frisé and matt lacquered colour "snow"/eucalyptus frisé et laqué opaque couleur "snow"/Eukalyptus Frisé und matt lackiert Farbe "Snow" • struttura/structure/structure/Struktur Glossy Browned
VALERY 1 TABLE consolle/console/console/Konsole
 • 1VLRCONDX • Top 1 marmo/marble/marbre/Marmor Calacatta White, Cat. X4 • top 2 vetro gofrato/embossed glass/verre gaufré/Pressglas • struttura/structure/structure/Struktur Glossy Browned
VALERY 1 TABLE tavolino/small table/table/Couchtisch 133x139
 • 1VL1TAV1 • Top marmo/marble/marbre/Marmor Calacatta White, Cat. X4 • struttura/structure/structure/Struktur Glossy Browned
VALERY 3 TABLE tavolino/small table/table/Couchtisch ø70
 • 1VL3TAVROT70 • Top Mink brown • struttura/structure/structure/Struktur Glossy Browned

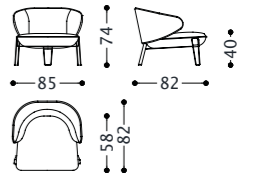
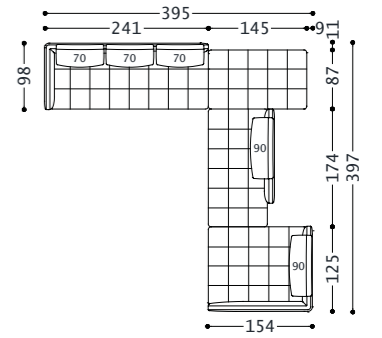

81



72

- VALERY** divano/sofa/canapé/Sofa
 • 01VLRC30 (1VLRD3MSX+1VLRDORMDX) • 8335 Gala 0518 talpa, Cat. 8 • staffa/stirrup/étrier/Bügel Glossy Browned
VERONIQUE 1 madia bassa/low cupboard/ buffet bas/niedriger Schrank
 • 1VE1MBB • Top marmo/marble/marbre/Marmor Calacatta White, Cat. X4 • base/Basis: eucalipto frisé e laccato opaco colore "snow"/eucalyptus frisé and matt lacquered colour "snow"/eucalyptus frisé et laqué opaque couleur "snow"/Eukalyptus Frisé und matt lackiert Farbe "Snow" • struttura/structure/structure/Struktur Glossy Browned
VALERY 1 TABLE tavolino/small table/table/Couchtisch 133x139
 • 1VL1TAV1 • Top marmo/marble/marbre/Marmor Calacatta White, Cat. X4 • struttura/structure/structure/Struktur Glossy Browned

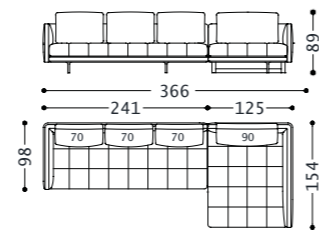

73



86

- VALERY** divano/sofa/canapé/Sofa
 • 03VLRC10 (2VLRMTTDX+1VLTAV) • 942 Fjord Dark Brown, Cat. G • staffa/stirrup/étrier/Bügel Glossy Browned • tavolino marmo/marble small table/table marbre/Marmor Cream Calacatta, Cat. X4
VALERY 3 TABLE tavolino/small table/table/Couchtisch ø70
 • 1VL3TAVROT70 • Top Mink brown • struttura/structure/structure/Struktur Glossy Browned

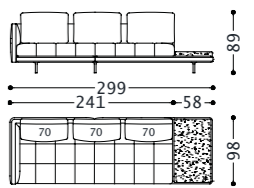

87

FINITURE • FINISHING



MARMO/MARBLE/MARBRE/MARMOR



Magic Brown • Cat. X1



Arabesque purple • Cat. X1



Daino Reale • Cat. X2



Verde Issorie • Cat. X4

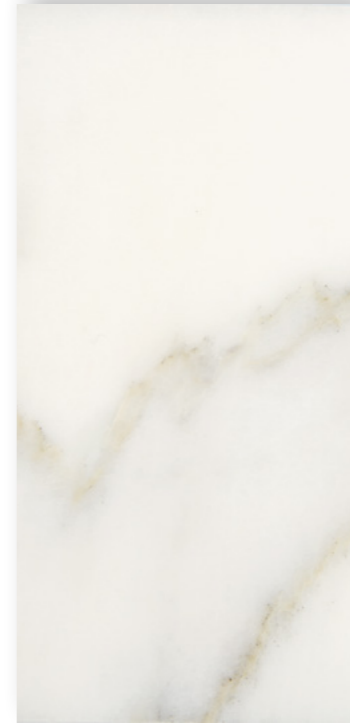

Calacatta White • Cat. X4



Cream Calacatta • Cat. X4



Marquina black • Cat. X2

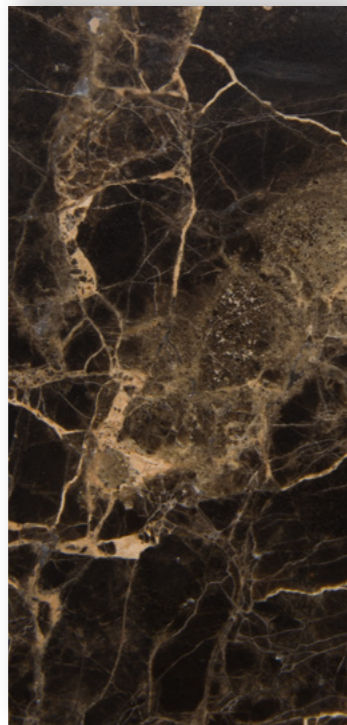

Emperador Brown • Cat. X3



Natural Travertino • Cat. X3

METALLO/METAL/MÉTAL/METALL

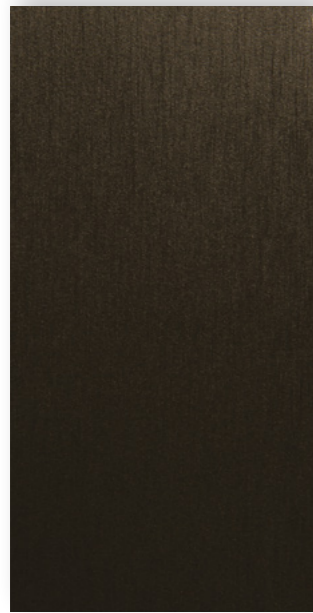

Gun Metal



French Bronze



Glossy browned

LEGNO/WOOD/BOIS/HOLZ



Noce Canaletto / Canaletto Walnut



Rovere Scuro / Dark Oak

LACCATI/LACQUERED/LAQUÉS/LACKIERT

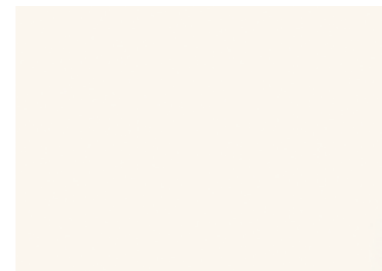

Ivory

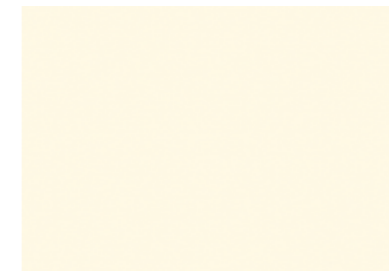

Cream

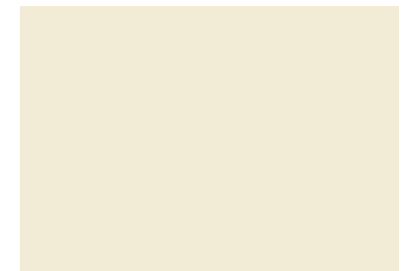

Snow



Mist



Grey



Dove Grey

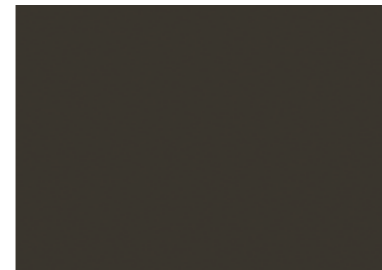

Mink Brown

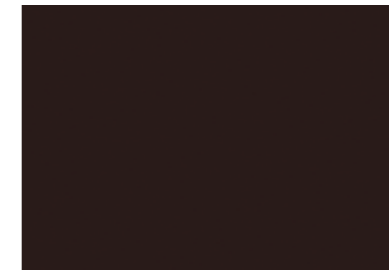

Dark brown



Green

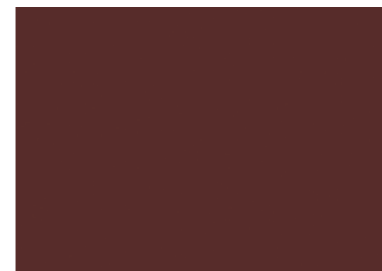

Bordeaux

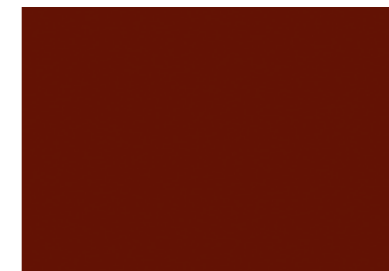

Rust

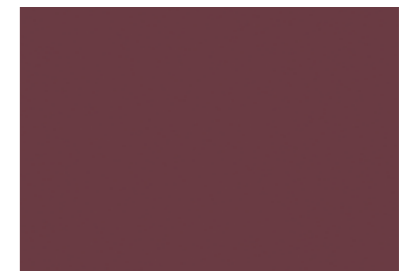

Burgundy



Blue

DATI TECNICI • TECHNICAL DATA

DIVANI • SOFAS

FLYNN	106
FEENIX	112
FREEDOM	114
VALERY	118

POLTRONE • ARMCHAIRS

CECILE	124
HONOLULU	111
SWEET JANE	125
JAMMIN	126
JAMMIN LARGE	127

POUFF • POUF

99	117
----------	-----

DATI TECNICI • TECHNICAL DATA

MOBILI • FURNITURE

VERONIQUE 1	123
-------------------	-----

TAVOLINI • SMALL TABLES

FEENIX 1 TABLE	128
VALERY 1 TABLE	130
VALERY 3 TABLE	131
FLYNN TABLES	129
ORIGAMI LUXURY GLASS	132
FRISCO	133
ISLAND	134
JIMMY 3	135
JAGGER	136
PHIL	137

FLYNN divano/sofa/canapé/Sofa
 elementi/elements/éléments/Elemente

Design by Maurizio Manzoni



Struttura portante: multistrato, massello di legno.
Imbottiture: cuscino di schienale in piuma d'oca. Cuscino di seduta e scocca in poliuretano espanso a densità differenziata con rivestimento in resinato.
Molle: cinghie elastiche in polipropilene e gomma.
Piedini: in metallo, h. 16 cm.

Main structure: multilayer and solid wood.
Upholstery: backrest cushion in goose feathers. Seat cushion and chassis in polyurethane foam with different densities covered with resinated.
Suspensions: elastic belts in polypropylene and rubber.
Feet: in metal, h. 16 cms.

Structure: multiplis et bois massif.
Rembourrage: coussin de dossier en plume d'oie. Coussin d'assise et chassis en mousse de polyuréthane en plusieurs densités revêtu de résine.
Suspension: sangles élastiques en polypropylène et mousse.
Pieds: en métal, h. 16 cm.

Struktur: vielschichtiges Massivholz.
Polsterung: Rückenlehne aus Gänsedaunen. Sitz und Chassis aus Polyurethanschaum in unterschiedlichen Dichte mit Resinat verkleidet.
Federung: elastische Gurte aus Gummi und Polypropylen.
Füße: aus Metall, H. 16 cm.

Cod. Tessuto/fabric/tissu/Stoff: 1/01
 Cod. Pelle/leather/cuir/Leder: 2/02

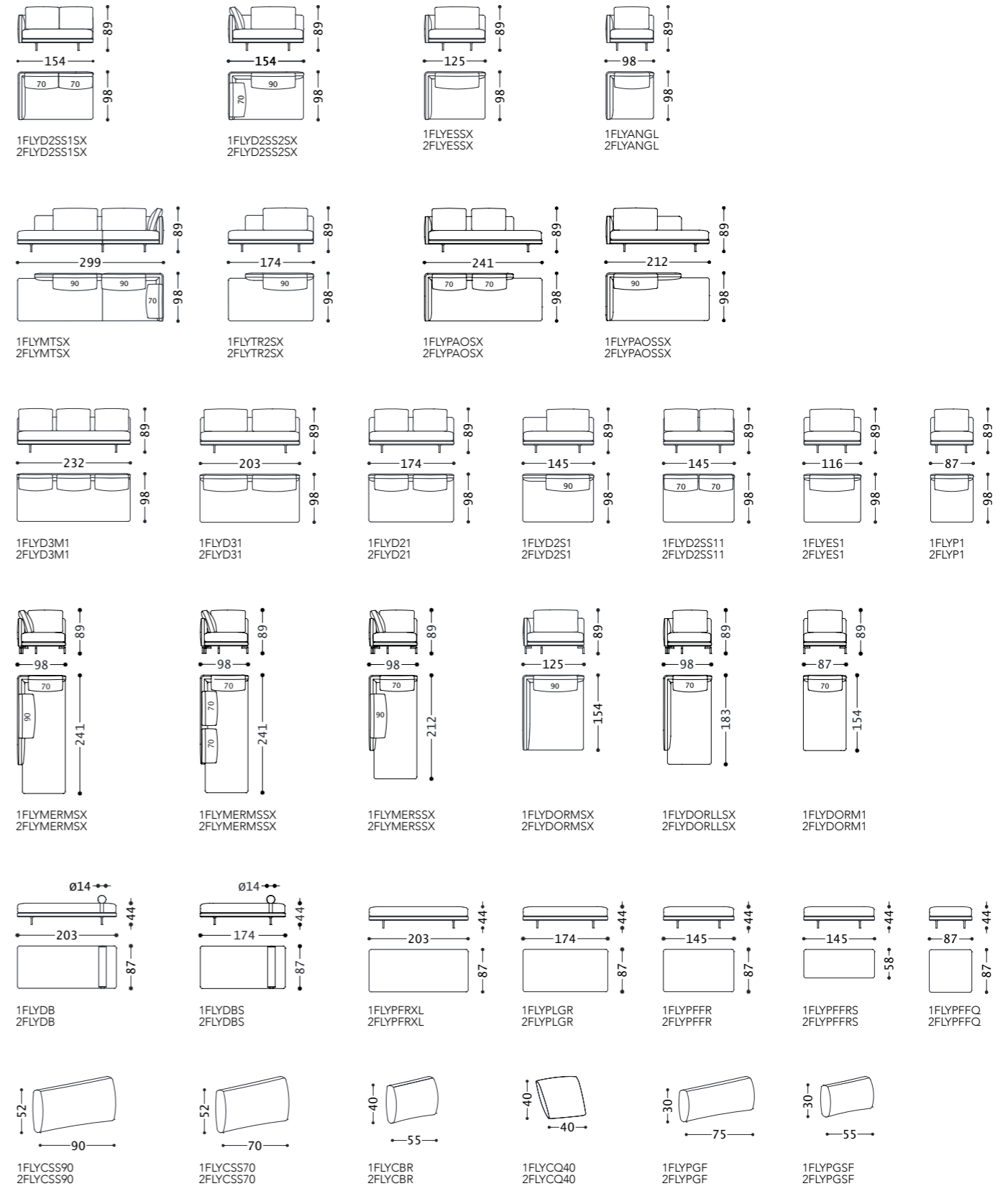
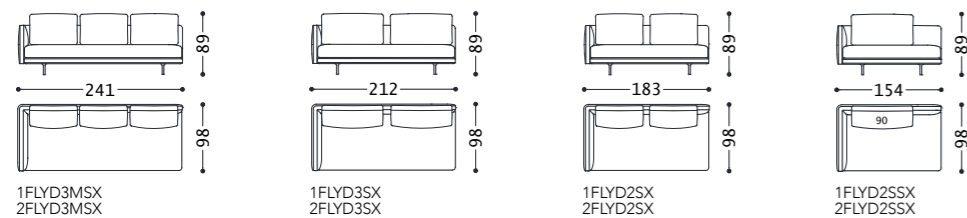
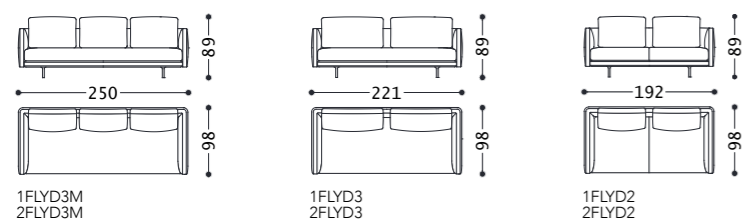
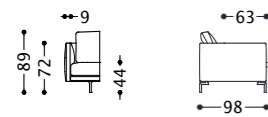

FLYNN divano/sofa/canapé/Sofa

elementi per tavolino/elements for small tables/éléments pour table/Elemente Für Couchtisch

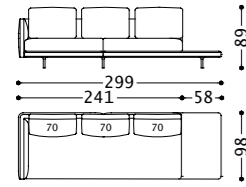

1FLYMTTDX
2FLYMTTDX

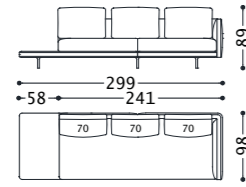

1FLYMTTSX
2FLYMTTSX

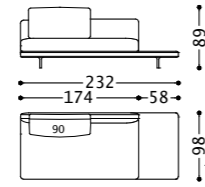

1FLYTR3TDX
2FLYTR3TDX

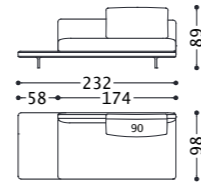

1FLYTR3TSX
2FLYTR3TSX

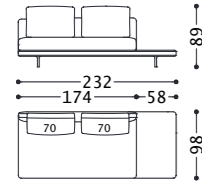

1FLYTR3STDx
2FLYTR3STDx

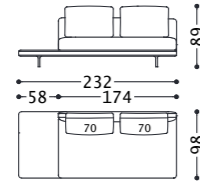

1FLYTR3STsX
2FLYTR3STsX

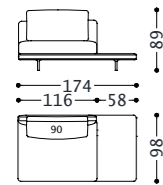

1FLYTR2STDx
2FLYTR2STDx

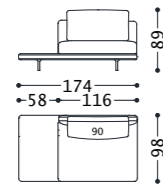

1FLYTR2STsX
2FLYTR2STsX

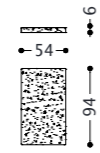

1FYTTAV

FLYNN divano/sofa/canapé/Sofa

composizioni/compositions/Kompositionen

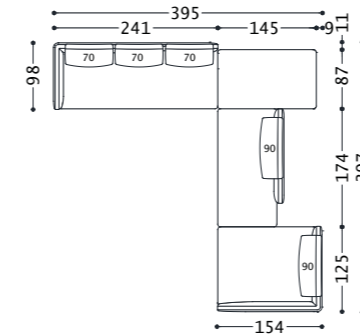

01FLYC1
(1FLYD3MSX+1FLYPFFR+1FLYTR2DX
+1FLYDORMDX)
02FLYC1
(2FLYD3MSX+2FLYPFFR+2FLYTR2DX
+2FLYDORMDX)

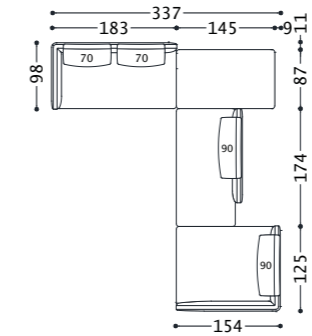

01FLYC2
(1FLYD2SX+1FLYPFFR+1FLYTR2DX
+1FLYDORMDX)
02FLYC2
(2FLYD2SX+2FLYPFFR+2FLYTR2DX
+2FLYDORMDX)

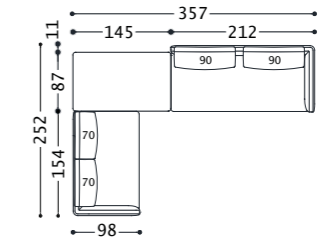

01FLYC27
(1FLYD2SS1SX+1FLYPFFR+1FLYD3DX)
02FLYC27
(2FLYD2SS1SX+2FLYPFFR+2FLYD3DX)

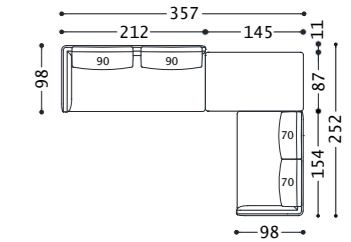

01FLYC28
(1FLYD3SX+1FLYPFFR+1FLYD2SS1DX)
02FLYC28
(2FLYD3SX+2FLYPFFR+2FLYD2SS1DX)

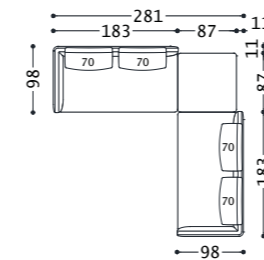

01FLYC9
(1FLYD2SX+1FLYPFFQ+1FLYD2DX)
02FLYC9
(2FLYD2SX+2FLYPFFQ+2FLYD2DX)

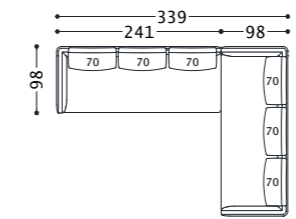

01FLYC8
(1FLYD3MSX+1FLYD3M)
02FLYC8
(2FLYD3MSX+2FLYD3M)

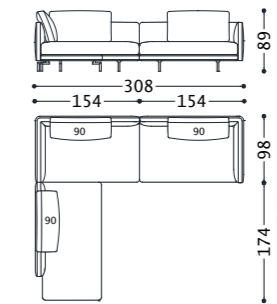

01FLYC3
(1FLYTR2SX+1FLYD2SSX+1FLYD2SDX)
02FLYC3
(2FLYTR2SX+2FLYD2SSX+2FLYD2SDX)

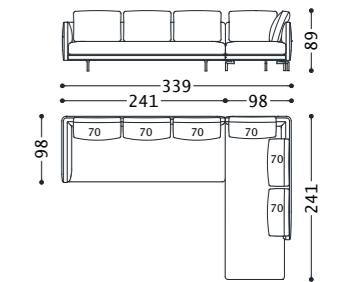

01FLYC5
(1FLYD3MSX+1FLYMERMSDX)
02FLYC5
(2FLYD3MSX+2FLYMERMSDX)

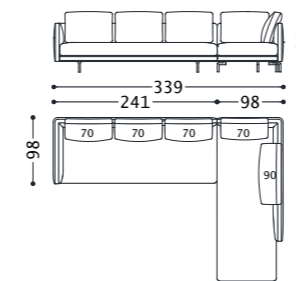

01FLYC6
(1FLYD3MSX+1FLYMERMSDX)
02FLYC6
(2FLYD3MSX+2FLYMERMSDX)

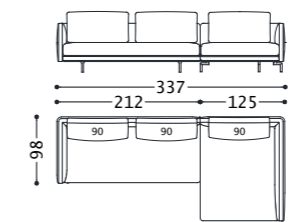

01FLYC4
(1FLYD3SX+1FLYDORMDX)
02FLYC4
(2FLYD3SX+2FLYDORMDX)

FLYNN divano/sofa/canapé/Sofa

composizioni con tavolino/compositions with small tables/compositions avec table/Kompositionen mit Couchtisch

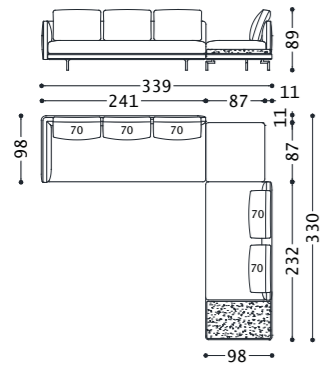

03FLYC24
(1FLYD3MSX+1FLYPFFQ+1FLYTR3STDx+1FYTTAV)
03FLYC25
(2FLYD3MSX+2FLYPFFQ+2FLYTR3STDx+1FYTTAV)

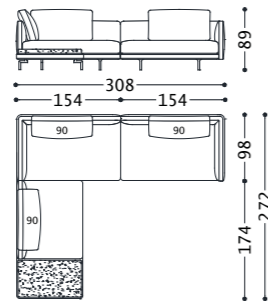

03FLYC20
(1FLYTR2STSx+1FYTTAV+1FLYD2SSx+1FLYD2SDx)
03FLYC21
(2FLYTR2STSx+1FYTTAV+2FLYD2SSx+2FLYD2SDx)

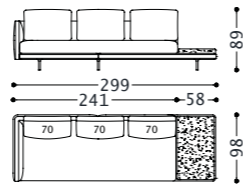

03FLYC11
(1FLYMTDX+1FYTTAV)
03FLYC10
(2FLYMTDX+1FYTTAV)

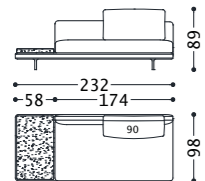

03FLYC15
(1FLYTR3TSx+1FYTTAV)
03FLYC18
(2FLYTR3TSx+1FYTTAV)

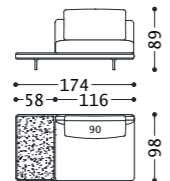

03FLYC14
(1FLYTR2STSx+1FYTTAV)
03FLYC17
(2FLYTR2STSx+1FYTTAV)

HONOLULU poltrona relax/relax armchair/fauteuil relax/Sessel relax

elementi/elements/éléments/Elemente

Design by Alberta Style Department



POLTRONA RELAX

Struttura portante: gabbia metallica.

Imbottiture: poliuretano espanso schiumato a freddo rivestito con resinato.

Struttura esterna: rivestita in multistrato impiallacciato a scelta: noce (Cod. 2HONPAGNO/2HONPAGNONV) o rovere naturale (Cod. 2HONPAGRN).

Meccanica: schienale reclinabile con comando manuale inserito all'interno del bracciolo. Poggiatesta regolabile. Meccanismo girevole con return memory.

Basamento per poltrona relax noce: 4 razze in alluminio lucido o nero verniciato.

Basamento per poltrona relax rovere naturale: 4 razze in alluminio lucido.

RELAX ARMCHAIR

Main structure: metal cage.

Upholstery: cold polyurethane foam covered with resinato.

Surface: covered in veneer-options: walnut (Cod. 2HONPAGNO/2HONPAGNONV) or natural oak (Cod. 2HONPAGRN).

Mechanics: reclining backrest with manual mechanism placed inside the armrest. Adjustable headrest. Swivel mechanism – return memory.

Base for relax armchair-walnut: 4 legged metal frame in glossy aluminum or varnished black.

Base for relax armchair-natural oak: 4 legged metal frame in glossy aluminum.

FAUTEUIL RELAX

Structure de support: cage métallique.

Rembourrage: mousse de polyuréthane à froid revêtu en résiné.

Structure extérieure: revêtu de placage de contreplaqué à choix: noyer (Cod. 2HONPAGNO/2HONPAGNONV), ou chêne naturel (Cod. 2HONPAGRN).

Mécanique: dossier réglable, avec commande manuelle disposé à l'intérieur de l'accoudoir. Appui-tête réglable. Mécanisme pivotant avec le retour.

Base pour fauteuil relax-noyer: 4 branches en aluminium poli ou noir verni.

Base pour fauteuil relax- chêne naturel: 4 branches en aluminium poli.

SESSEL RELAX

Hauptstruktur: Metallkäfig.

Polsterung: Kaltpolyurethanschaum mit Resinat bedeckt.

Außenstruktur: aus Schichtholz furniert-Auswahl: Nussbaum (Cod. 2HONPAGNO/2HONPAGNONV) oder Eiche (Cod. 2HONPAGRN).

Mechanik: Verstellbare Rückenlehne, mit manueller Steuerung mit Innern der Armlehne eingefügt. Verstellbare Kopfstütze. Drehmechanismus mit "Return Memory".

Basis für Sessel relax -Nussbaum: vierspeiche aus glänzendem Aluminium oder Schwarz lackiert.

Basis für Sessel relax -Eiche: vierspeiche aus glänzendem Aluminium.

POUFF

Struttura portante: multistrato.

Imbottitura: poliuretano espanso.

Struttura esterna: rivestita in multistrato impiallacciato a scelta: noce (Cod. 2HONPOUFFNO/2HONPOUFFNONV) o rovere naturale (Cod. 2HONPOUFFRN).

Basamento per pouff noce: 4 razze in alluminio lucido o nero verniciato.

Basamento per pouff rovere naturale: 4 razze in alluminio lucido.

POUE

Main structure: multilayer.

Upholstery: polyurethane foam.

Surface: covered with veneer multilayer wood: walnut (Cod. 2HONPOUFFNO/2HONPOUFFNONV) or natural oak (Cod. 2HONPOUFFRN).

Base for pouf-walnut: 4 legged metal frame in glossy aluminum or varnished black.

Base for pouf-natural oak: 4 legged metal frame in glossy aluminum.

POUF

Structure de support: multiplis.

Rembourrage: mousse de polyuréthane.

Structure extérieure: revêtu de placage de contreplaqué à choix: noyer (Cod. 2HONPOUFFNO/2HONPOUFFNONV), ou chêne naturel (Cod. 2HONPOUFFRN).

Base pour pouf-noyer: 4 branches en aluminium poli ou noir verni.

Base pour pouf- chêne naturel: 4 branches en aluminium poli.

HOCKER

Hauptstruktur: Massivholz.

Polsterung: Polyurethanschaum.

Außenstruktur: aus Schichtholz furniert-Auswahl: Nussbaum (Cod. 2HONPOUFFNO/2HONPOUFFNONV) oder Eiche (Cod. 2HONPOUFFRN).

Basis für Hocker-Nussbaum: vierspeiche aus glänzendem Aluminium oder Schwarz lackiert.

Basis für Hocker-Eiche: vierspeiche aus glänzendem Aluminium.

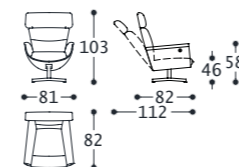

2HONPAGNO
2HONPAGNONV
2HONPAGRN

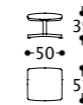

2HONPOUFFNO
2HONPOUFFNONV
2HONPOUFFRN

FEENIX divano/sofa/canapé/Sofa
elementi/elements/éléments/Elemente

Design by Maurizio Manzoni



Struttura portante: multistrato, massello di legno.
Imbottiture: schienale in poliuretano espanso a densità differenziata. Cuscino di seduta in poliuretano espanso a densità differenziata, rivestito in falda termolegata; imbottitura in piuma d'oca e fibra di poliestere con rivestimento in tela di cotone. Bracciolo in poliuretano espanso (densità 40 kg/mc). Scocca in poliuretano espanso a densità differenziata.
Molle: cinghie elastiche in polipropilene e gomma.
Base: staffa metallica, h. 15,5 cm.

Main structure: multilayer and solid wood.
Upholstery: backrest in polyurethane foam with different densities. Seat cushion in polyurethane foam with different densities, covered with heat-bonded layer; padding in goose feather and polyester fiber covered with cotton fabric. Armrest in polyurethane foam (density 40 kg/mc). Chassis in polyurethane foam with different densities.
Suspensions: elastic belts in polypropylene and rubber.
Base: metal stirrup, h. 15,5 cms.

Structure: multiplis et bois massif.
Rembourrage: dossier en mousse de polyuréthane en plusieurs densités. Coussin d'assise en mousse de polyuréthane en plusieurs densités, revêtu en fibre thermolée; rembourrage en plume d'oie et fibre de polyester sous housse de coton. Accoudoir en mousse de polyuréthane (densité 40 kg/mc). Chassis en mousse de polyuréthane en plusieurs densités.
Suspension: sangles élastiques en polypropylène et mousse.
Base: étrier en métal, h. 15,5 cm.

Hauptstruktur: vielschichtiges Massivholz.
Polsterung: Rückenlehne aus Polyurethanschaum in unterschiedlichen Dichte. Sitz aus Polyurethanschaum mit unterschiedlicher Dichte mit heiss geklebter Abdeckung; Polsterung aus Gänsedaunen und Polyesterfaser mit Baumwolle bezug verkleidet. Armlehne aus Polyurethanschaum (Dichte 40 kg/mc). Chassis aus Polyurethanschaum in unterschiedlichen Dichte.
Federung: elastische Gurte aus Gummi und Polypropylen.
Basis: Metallbügel, h.15,5 cm.

Cod. Tessuto/fabric/tissu/Stoff: 1/01
Cod. Pelle/leather/cuir/Leder: 2/02

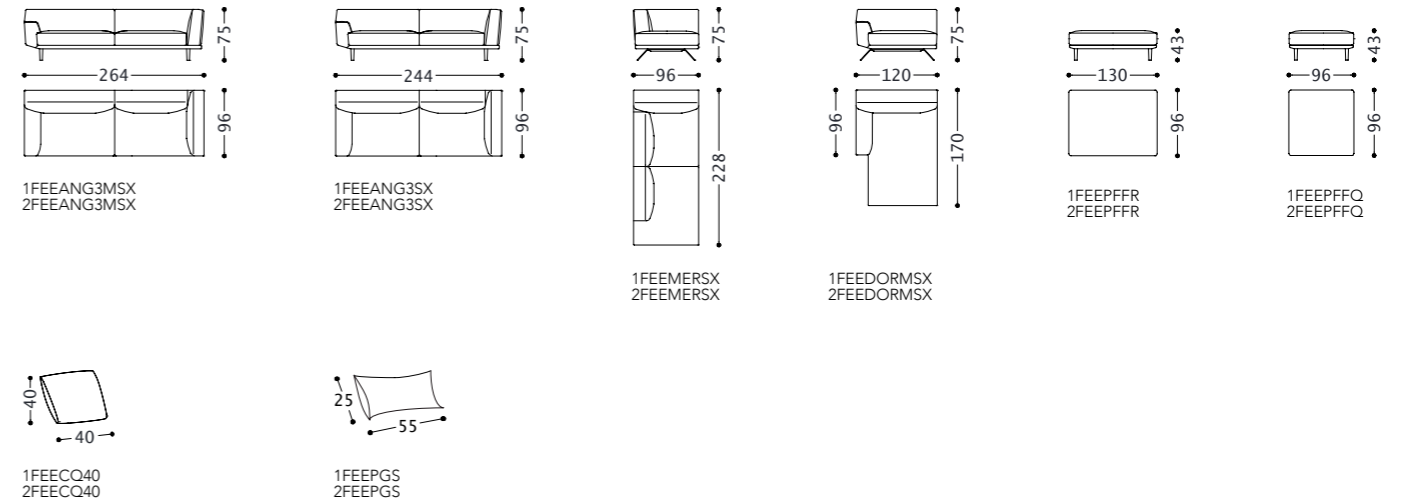
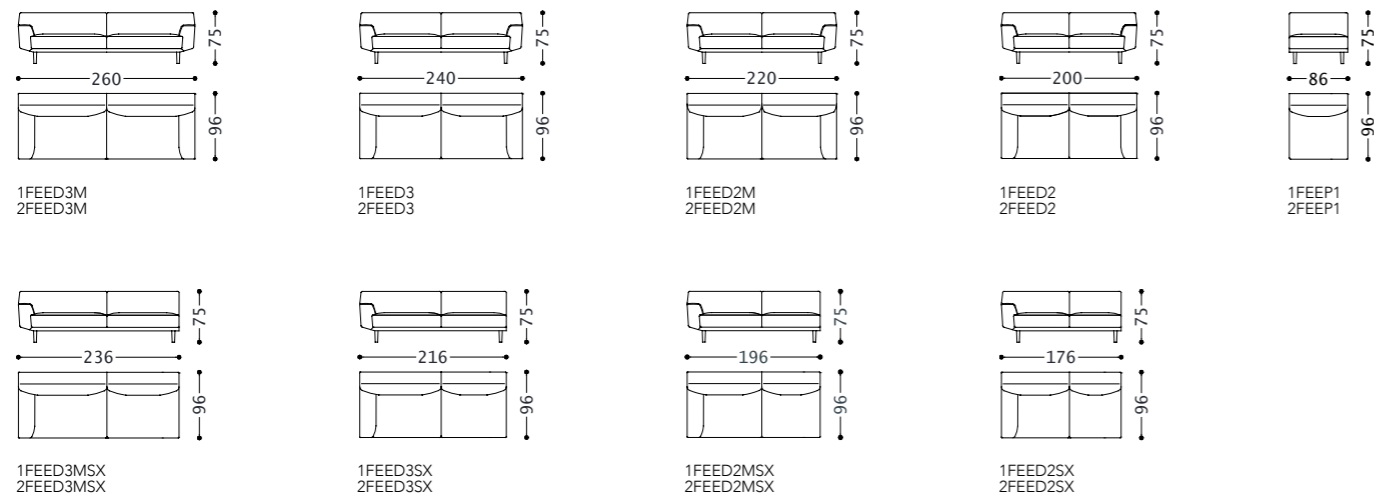
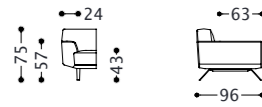

FEENIX divano/sofa/canapé/Sofa
composizioni/compositions/Kompositionen

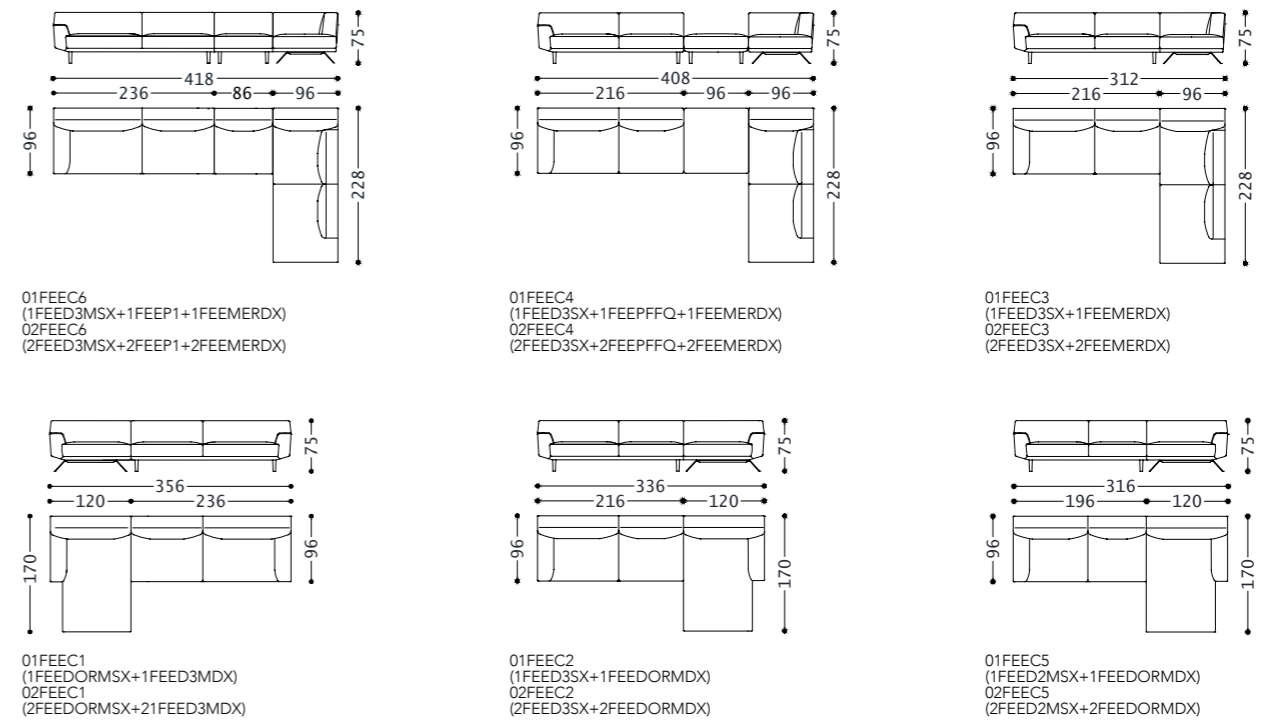

FREEDOM

divano/sofa/canapé/Sofa
elementi/elements/éléments/Elemente

Design by Alberta Style Department



Struttura portante: multistrato, massello di legno. Schiene in multistrato con rinforzo in metallo.
Imbottiture: schiene, sedute e bracciolo in poliuretano espanso a densità differenziata, rivestito in fibra di poliestere e resinato gr. 100. Cuscini optional in piuma d'oca e fibra di poliestere con rivestimento in tela di cotone.
Molleggio: cinghie elastiche in polipropilene e gomma.
Piedini: metallo, h. 15 cm.

Main structure: multilayer and solid wood. Backrests in multilayer with metal support.
Upholstery: backrests, seats and armrest in polyurethane foam with different densities covered with polyester fiber and resinated 100 grams. Optional pillows in goose feathers and polyester fiber covered with cotton fabric.
Suspensions: elastic belts in polypropylene and rubber.
Feet: metal, h. 15 cms.

Structure: multiplis et bois massif. Dossiers en multiplis et renforcement métallique.
Rembouillage: dossiers, assises et accoudoir en mousse de polyuréthane en plusieurs densités revêtus en fibre de polyester et résiné 100 gr. Coussins en plumes d'oie et fibre de polyester sous housse de coton.
Suspension: sangles élastiques en polypropylène et mousse.
Pieds: métal, h. 15 cm.

Hauptstruktur: vielschichtiges Massivholz. Rückenlehne aus vielschichtiges Massivholz mit Metallverstärkung.
Polsterung: Rückenlehne, Sitze und Armlehne aus Polyurethanschaum mit unterschiedlicher Dichte mit Polyesterfaser und Resinat 100 Gramm verkleidet. Kissen aus Gänsedaunen und Polyesterfaser mit Baumwollstoffe bedeckt.
Federung: elastische Gurte aus Gummi und Polypropylen.
Füße: Metall, h.15 cm.

Cod. Tessuto/fabric/tissu/Stoff: 1/01
Cod. Pelle/leather/cuir/Leder: 2/02

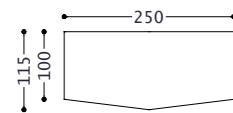
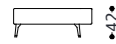

1FREEA250
2FREEA250

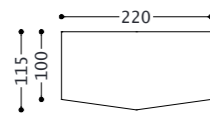

1FREEA220
2FREEA220

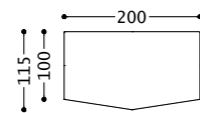

1FREEA200
2FREEA200

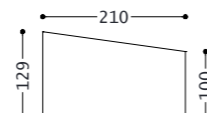

1FREEB
2FREEB

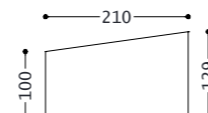

1FREEC
2FREEC

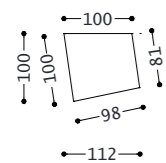

1FREED
2FREED

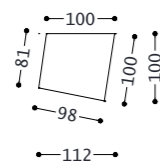

1FREEE
2FREEE

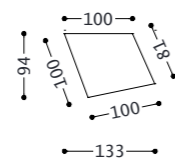

1FREEF
2FREEF

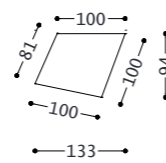

1FREEG
2FREEG

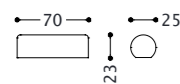

1FRESCH1
2FRESCH1

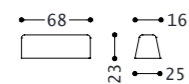

1FRESCH3
2FRESCH3

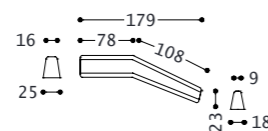

1FRESCH4
2FRESCH4

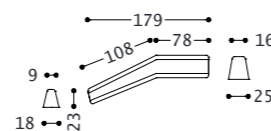

1FRESCH5
2FRESCH5

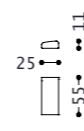

1FREBR
2FREBR

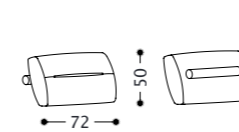

1FRECGC
2FRECGC

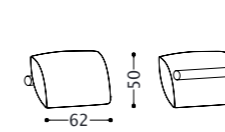

1FRECL
2FRECL

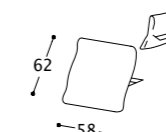

1FRECSS
2FRECSS

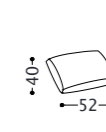

1FRECR
2FRECR

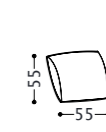

1FRECO55B
2FRECO55B

FREEDOM

divano/sofa/canapé/Sofa
composizioni/compositions/Kompositionen

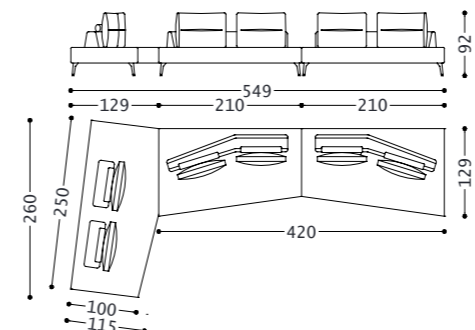

01FREC10
(1FREEA250+1FREEB+1FREEC+1FRESCH3 (nr.2)+1FRESCH5
+1FRESCH4+1FRECGC (nr.6))
02FREC10
(2FREEA250+2FREEB+2FREEC+2FRESCH3 (nr.2)+2FRESCH5
+2FRESCH4+2FRECGC (nr.6))

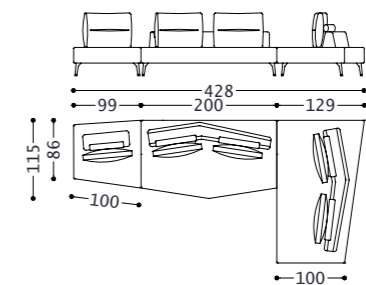

01FREC9
(1FREED+1FREEA200+1FREEB+1FRESCH3
+1FRESCH4 (nr.2)+1FRECGC (nr.5))
02FREC9
(2FREED+2FREEA200+2FREEB+2FRESCH3
+2FRESCH4 (nr.2)+2FRECGC (nr.5))

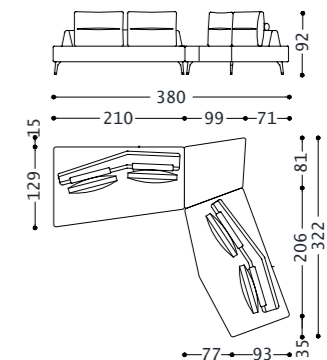

01FREC19
(1FREEC+1FREEG+1FREEA220+1FRESCH5
(nr.2)+1FRECGC (nr.4))
02FREC19
(2FREEC+2FREEG+2FREEA220+2FRESCH5
(nr.2)+2FRECGC (nr.4))

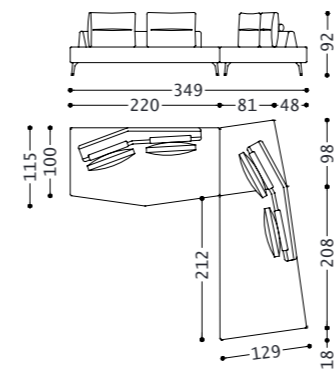

01FREC3
(1FREEA220+1FREED+1FREEB
+1FRESCH4 (nr.2)+1FRECGC (nr.4))
02FREC3
(2FREEA220+2FREED+2FREEB
+2FRESCH4 (nr.2)+2FRECGC (nr.4))

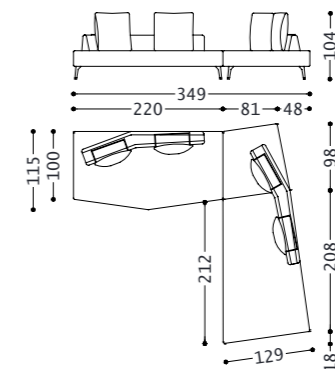

01FREC4
(1FREEA220+1FREED+1FREEB+1FRESCH4 (nr.2)
+1FRECSS (nr.4))
02FREC4
(2FREEA220+2FREED+2FREEB+2FRESCH4 (nr.2)
+2FRECSS (nr.4))

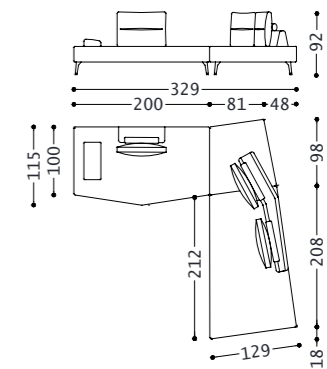

01FREC5
(1FREEA200+1FREED+1FREEB+1FRESCH3
+1FRESCH4+1FREBR+1FRECGC (nr.3))
02FREC5
(2FREEA200+2FREED+2FREEB+2FRESCH3
+2FRESCH4+2FREBR+2FRECGC (nr.3))

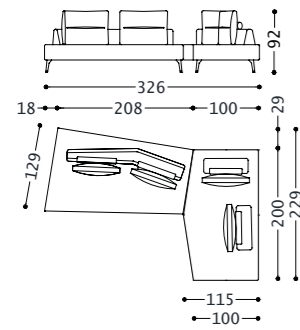

01FREC15
 (1FREEB+1FREEA200+1FRESCH5
 +1FRESCH3 (nr.2)+1FRECGC (nr.4))
 02FREC15
 (2FREEB+2FREEA200+2FRESCH5
 +2FRESCH3 (nr.2)+2FRECGC (nr.4))

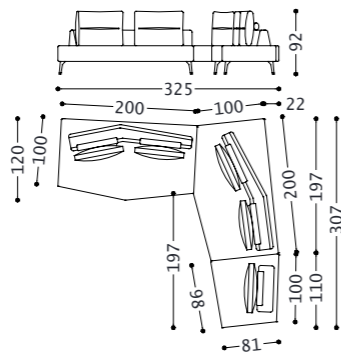

01FREC8
 (1FREEA200 (nr.2)+1FREED+1FRESCH5
 +1FRESCH4+1FRESCH3+1FRECGC (nr.5))
 02FREC8
 (2FREEA200 (nr.2)+2FREED+2FRESCH5
 +2FRESCH4+2FRESCH3+2FRECGC (nr.5))

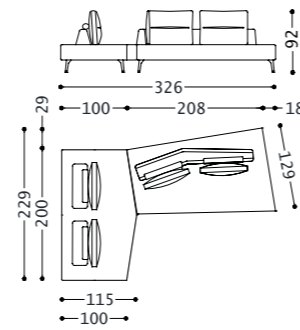

01FREC16
 (1FREEA200+1FREEB+1FRESCH3 (nr.2)
 +1FRESCH4+1FRECGC (nr.4))
 02FREC16
 (2FREEA200+2FREEB+2FRESCH3 (nr.2)
 +2FRESCH4+2FRECGC (nr.4))

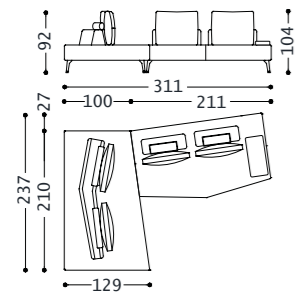

01FREC17
 (1FREEA200+1FREEC+1FRESCH5+1FRESCH3 (nr.2)
 +1FREBR+1FRECGC (nr.2)+1FRECSS (nr.2))
 02FREC17
 (2FREEA200+2FREEC+2FRESCH5+2FRESCH3 (nr.2)
 +2FREBR+2FRECGC (nr.2)+2FRECSS (nr.2))

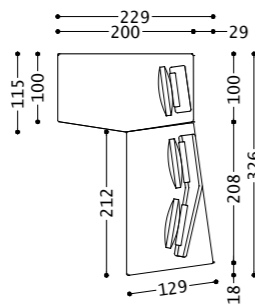

01FREC6
 (1FREEA200+1FREEB+1FRESCH3
 +1FRESCH4+1FRECGC (nr.3))
 02FREC6
 (2FREEA200+2FREEB+2FRESCH3
 +2FRESCH4+2FRECGC (nr.3))

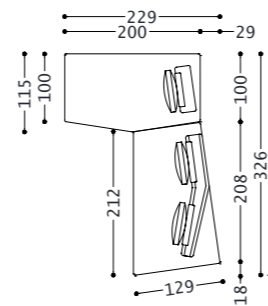

01FREC7
 (1FREEA200+1FREEB+1FRESCH3
 +1FRESCH4+1FRECL (nr.3))
 02FREC7
 (2FREEA200+2FREEB+2FRESCH3
 +2FRESCH4+2FRECL (nr.3))

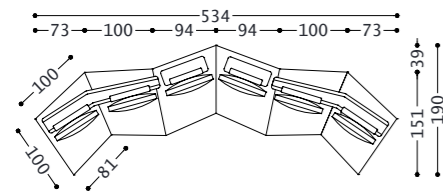

01FREC11
 (1FREEF (nr.3)+1FREEG (nr.3)+1FRESCH4
 +1FRESCH3 (nr.2)+1FRESCH5+1FRECGC (nr.6))
 02FREC11
 (2FREEF (nr.3)+2FREEG (nr.3)+2FRESCH4
 +2FRESCH3 (nr.2)+2FRESCH5+2FRECGC (nr.6))

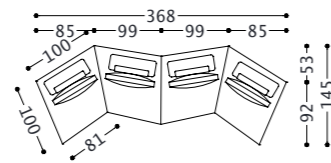

01FREC14
 (1FREEF (nr.2)+1FREEG (nr.2)
 +1FRESCH3 (nr.4)+1FRECGC (nr.4))
 02FREC14
 (2FREEF (nr.2)+2FREEG (nr.2)
 +2FRESCH3 (nr.4)+2FRECGC (nr.4))

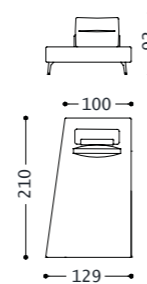

01FREC18
 (1FREEB+1FRESCH3+1FRECGC)
 02FREC18
 (2FREEB+2FRESCH3+2FRECGC)



Struttura portante: multistrato, massello di legno.
Imbottitura: poliuretano espanso a densità differenziata rivestito in resinato.
Piedini: in ABS

Main structure: multilayer and solid wood.
Upholstery: polyurethane foam with different densities covered with resinat.
Feet: ABS

Structure: multiplis et bois massif.
Rembourrage: mousse de polyuréthane en plusieurs densités revêtu de résine.
Pied: en ABS

Struktur: vielschichtiges Massivholz.
Polsterung: aus Polyurethanschaum in unterschiedlichen Dichte mit Resinat verkleidet.
FüÙe: ABS

Cod. Tessuto/fabric/tissu/Stoff: 1
 Cod. Pelle/leather/cuir/Leder: 2

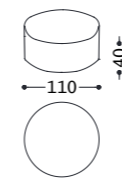

POUFFO99
 299PFFO



199POP
 299POP

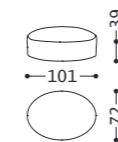

199PFFVG
 299PFFVG

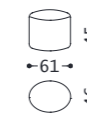

POUFFOV99
 299PFFV

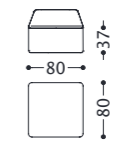

PFF8099
 299PFFQ

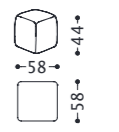

POUFFQB99
 299PFFB

VALERY divano/sofa/canapé/Sofa
elementi/elements/éléments/Elemente

Design by Maurizio Manzoni



Struttura portante: multistrato, massello di legno.
Imbottiture: cuscino di schienale in piuma d'oca. Cuscino di seduta e scocca in poliuretano espanso a densità differenziata con rivestimento in resinato.
Molle: cinghie elastiche in polipropilene e gomma.
Base: staffa metallica, h. 16 cm.

Main structure: multilayer and solid wood.
Upholstery: backrest cushion in goose feathers. Seat cushion and chassis in polyurethane foam with different densities covered with resinated.
Suspensions: elastic belts in polypropylene and rubber.
Base: metal stirrup, h. 16 cms.

Structure: multiplis et bois massif.
Rembourrage: coussin de dossier en plume d'oie. Coussin d'assise et chassis en mousse de polyuréthane en plusieurs densités revêtu de résine.
Suspension: sangles élastiques en polypropylène et mousse.
Base: étrier en métal, h. 16 cm.

Struktur: vielschichtiges Massivholz.
Polsterung: Rückenlehne aus Gänsedaunen. Sitz und Chassis aus Polyurethanschaum in unterschiedlichen Dichte mit Resinat verkleidet.
Federung: elastische Gurte aus Gummi und Polypropylen.
Basis: Metallbügel, H. 16 cm.

Cod. Tessuto/fabric/tissu/Stoff: 1/01
Cod. Pelle/leather/cuir/Leder: 2/02

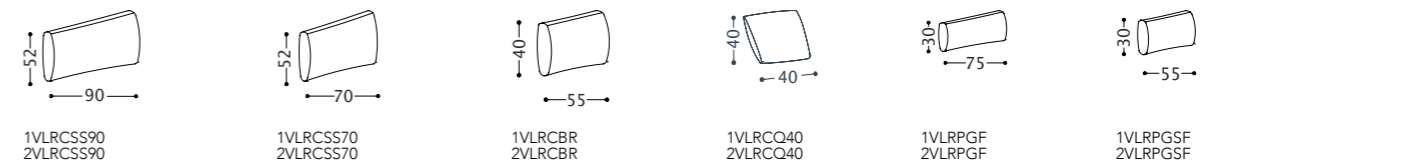
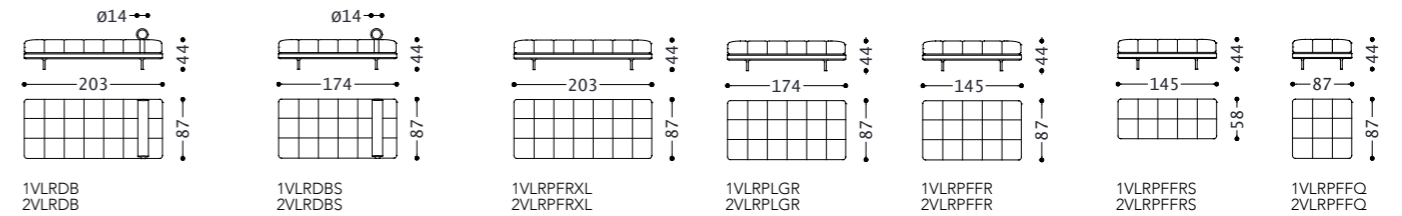
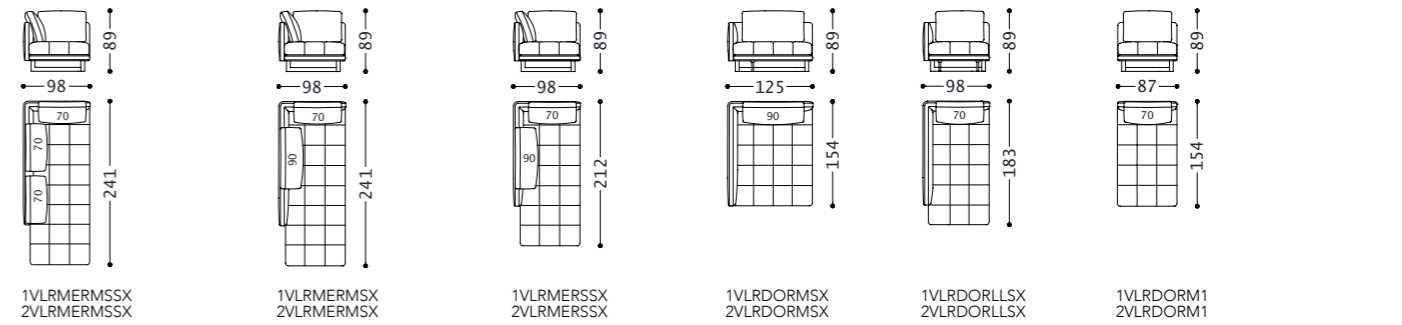
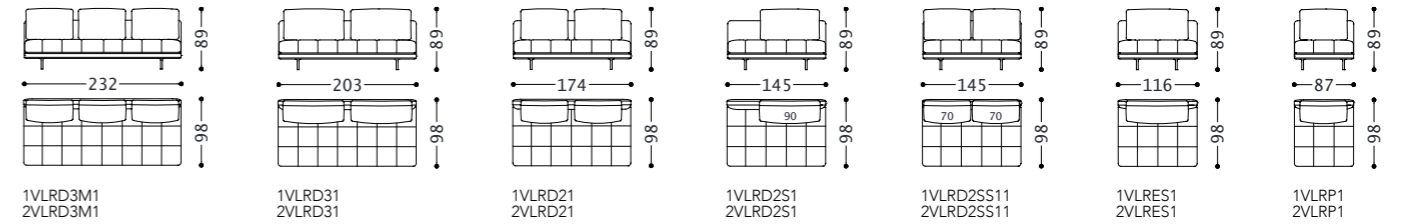
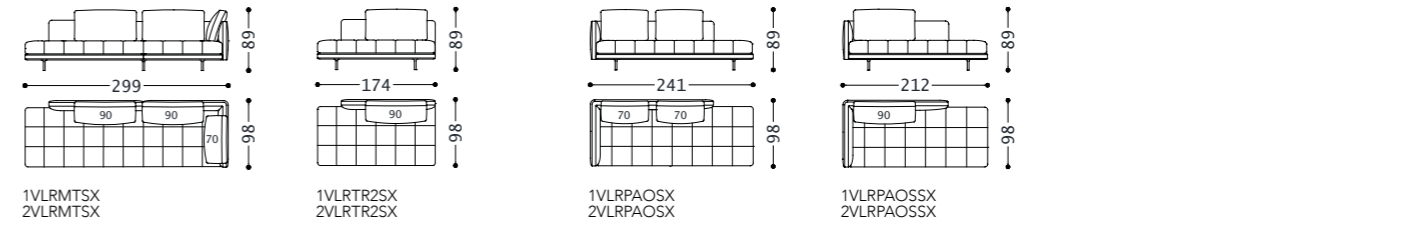
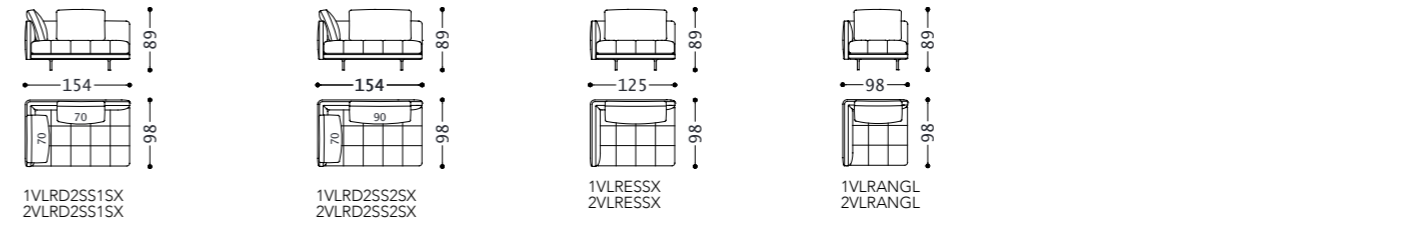
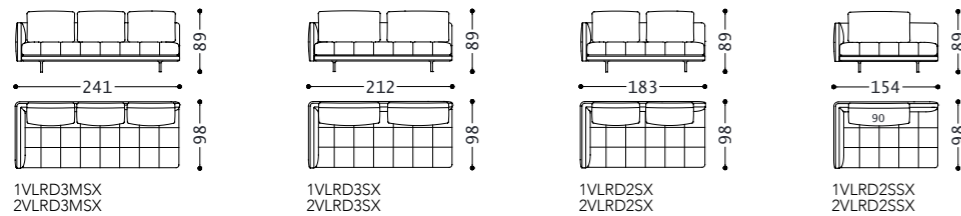
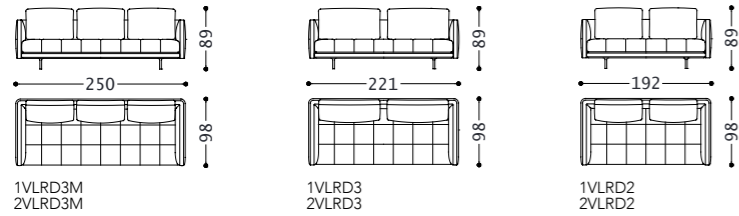
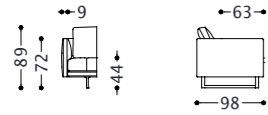

VALERY divano/sofa/canapé/Sofa

elementi per tavolino/elements for small tables/éléments pour table/Elemente für Couchtisch

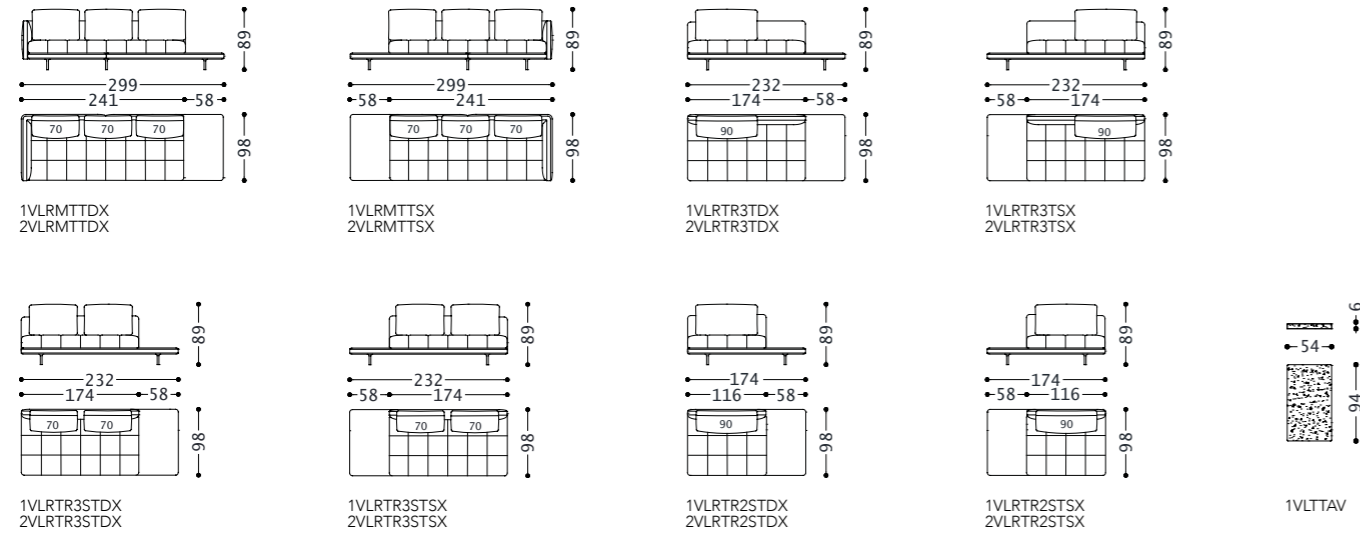

VALERY divano/sofa/canapé/Sofa

composizioni/compositions/Kompositionen

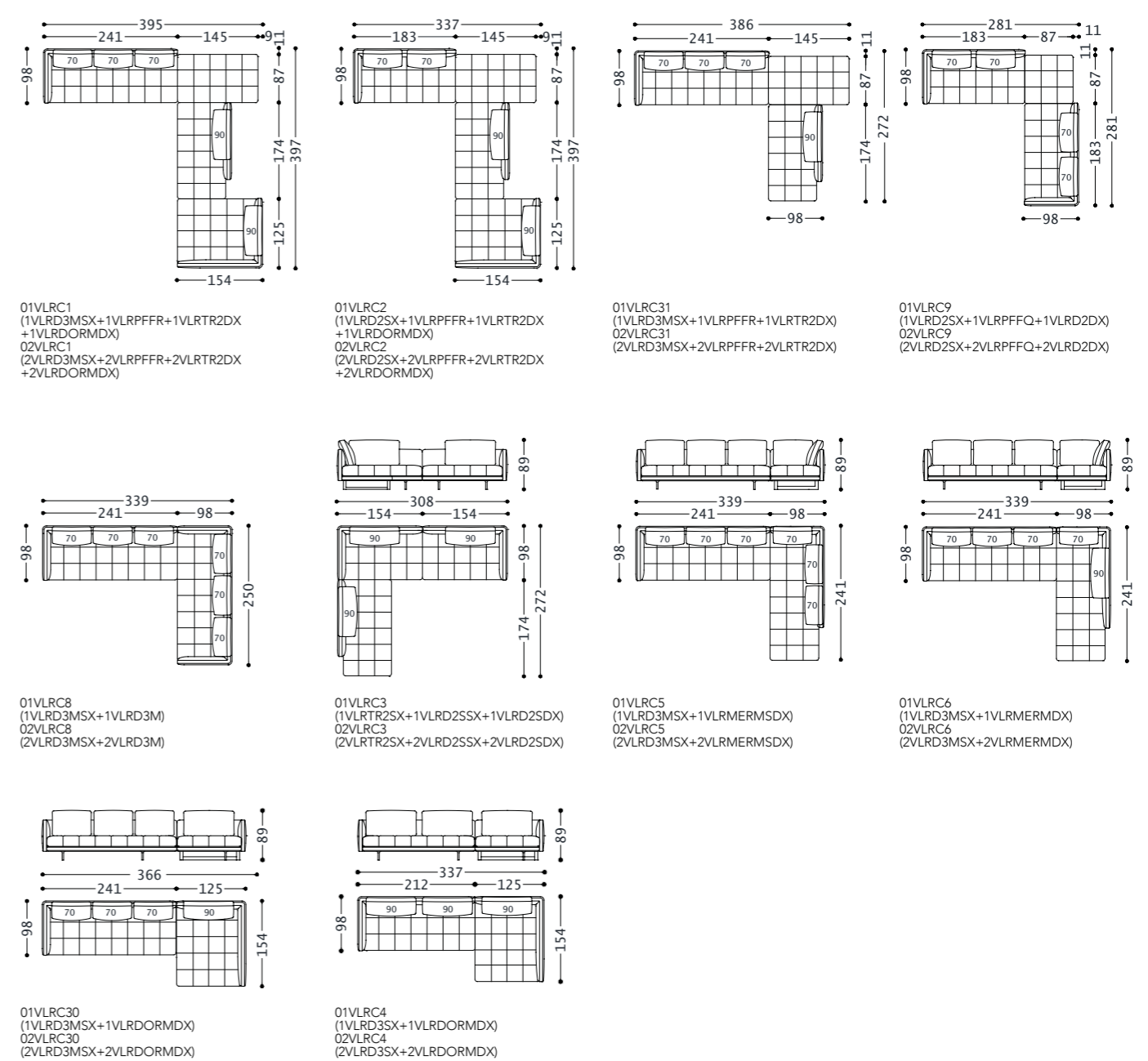

VALERY divano/sofa/canapé/Sofa

composizioni con tavolino/compositions with small tables/compositions avec table/Kompositionen mit Couchtisch

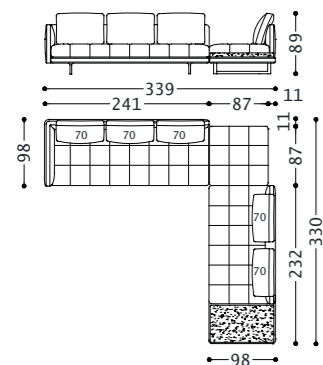

03VLRC24
(1VLRD3MSX+1VLRPFQ+1VLRTR3STDx+1VLTTAV)
03VLRC25
(2VLRD3MSX+2VLRPFQ+2VLRTR3STDx+1VLTTAV)

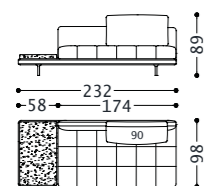

03VLRC15
(1VLRTR3TSX+1VLTTAV)
03VLRC18
(2VLRTR3TSX+1VLTTAV)

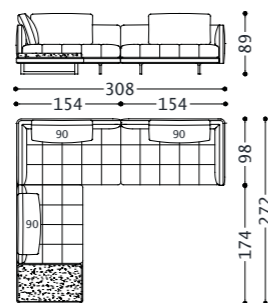

03VLRC20
(1VLRTR2STX+1VLRD2SSX+1VLRD2SDX+1VLTTAV)
03VLRC21
(2VLRTR2STX+2VLRD2SSX+2VLRD2SDX+1VLTTAV)

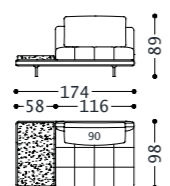

03VLRC14
(1VLRTR2STX+1VLTTAV)
03VLRC17
(2VLRTR2STX+1VLTTAV)

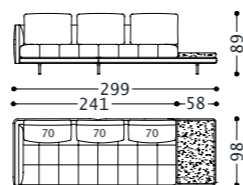

03VLRC11
(1VLRMTDX+1VLTTAV)
03VLRC10
(2VLRMTDX+1VLTTAV)

VERONIQUE 1 mobili/furniture/meubles/Möbel

elementi/elements/éléments/Elemente

Design by Maurizio Manzoni



Corpo esterno: MDF impiallacciato eucalipto frisè e laccato lucido (per mobile porta tv); MDF impiallacciato eucalipto frisè e laccato opaco (per madie)
Interno: MDF impiallacciato eucalipto frisè e laccato lucido (per mobile porta tv); MDF impiallacciato eucalipto frisè e laccato opaco (per madie)
Top: marmo e MDF laccato lucido (per mobile porta tv); marmo (per madie).
Base: metallo.

External structure: MDF veneer eucalyptus "frisè" and glossy lacquered (for tv cabinet); MDF veneer eucalyptus "frisè" and matt lacquered (for cupboards).
Internal-side: MDF veneer eucalyptus "frisè" and glossy lacquered (for tv cabinet); MDF veneer eucalyptus "frisè" and matt lacquered (for cupboards).
Plateau: marble and MDF glossy lacquered (for tv cabinet); marble (for cupboards).
Base: metal.

Structure extérieure: MDF placage eucalyptus frisè et laqué brillant (pour meuble tv); MDF placage eucalyptus frisè et laqué opaque (pour buffets).
Intérieur: MDF placage eucalyptus frisè et laqué brillant (pour meuble tv); MDF placage eucalyptus frisè et laqué opaque (pour buffets).
Plateau: marbre et MDF laqué brillant (pour meuble tv); marbre (pour buffets).
Base: métal.

Aussenstruktur: furniert MDF Eukalyptus Frisé und glänzend lackiert (für Fernsehschrank); furniert MDF Eukalyptus Frisé und matt lackiert (für Schränke).
Innenseite: furniert MDF Eukalyptus Frisé und glänzend lackiert (für Fernsehschrank); furniert MDF Eukalyptus Frisé und matt lackiert (für Schränke).
Top: Marmor und MDF glänzend lackiert (für Fernsehschrank); Marmor (für Schränke).
Basis: Metall.

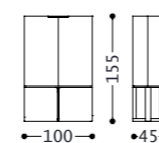

1VE1MAA

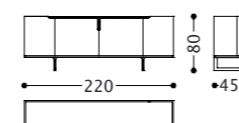

1VE1MBB

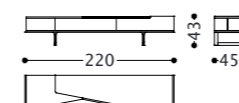

1VE1MOBTv

CECILE poltrona/armchair/fauteuil/Sessel

elementi/elements/éléments/Elemente

Design by Maurizio Manzoni



Struttura cuscino schiena: Pannello in multistrato.

Struttura portante: Legno/Metallo.

Imbottiture: Cuscino di schienale in piuma d'oca e fibra di poliestere con inserto in poliuretano espanso (densità 25 kg/mc) rivestito in tela di cotone. Cuscino di seduta in poliuretano espanso (densità 35 kg/mc), piuma d'oca e fibra di poliestere rivestito in tela di cotone.

Molle: Cinghie elastiche in polipropilene e gomma.

Back cushion structure: Multilayer panel.

Main structure: Wood/Metal.

Upholstery: Backrest in goose feathers and polyester fiber with internal padding in polyurethane foam (density 25 kg/mc) covered with cotton fabric. Seat cushion in polyurethane foam (density 35 kg/mc), goose feathers and polyester fiber, covered with cotton fabric.

Suspensions: Elastic belts in polypropylene and rubber.

Structure coussin de dossier: Panneau multiplis.

Structure: Bois/ Métal.

Rembourrage: Coussin de dossier en plumes d'oie et fibre de polyester avec insert en mousse de polyuréthane (densité 25 Kg/mc) sous housse de coton. Coussin d'assise en mousse de polyuréthane (densité 35 Kg/mc), plumes d'oie et fibre de polyester sous housse de coton.

Suspension: Sangles élastiques en polypropylène et mousse.

Rückenkissenstruktur: Schichtholz-Paneel.

Hauptstruktur: Holz/Metall.

Polsterung: Rückenkissen aus Gänsedaunen und Polyesterfaser mit Einsatz aus Polyurethanschaum (Dichte 25 kg/mc) mit Baumwolle bezug verkleidet. Sitz aus Polyurethanschaum (Dichte 35 kg/mc), Gänsedaunen und Polyesterfaser mit Baumwolle bezug verkleidet.

Federung: Elastische Gurte aus Gummi und Polypropylen.

Cod. Tessuto/fabric/tissu/Stoff: 1

Cod. Pelle/leather/cuir/Leder: 2

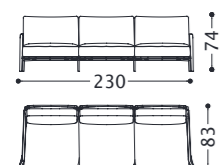
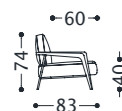

1CECD3NC
2CECD3NC

1CECD3W
2CECD3W

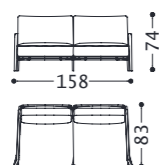

1CECD2NC
2CECD2NC

1CECD2W
2CECD2W



1CECPNC
2CECPNC

1CECPW
2CECPW

SWEET JANE poltrona/armchair/fauteuil/Sessel

elementi/elements/éléments/Elemente

Design by Maurizio Manzoni



Struttura portante: multistrato, massello di legno.

Struttura cuscino schienale: in metallo.

Imbottiture: schienale e seduta in poliuretano espanso a densità differenziata.

Molle: cinghie elastiche in polipropilene e gomma.

Gambe: in metallo.

Main structure: multilayer and solid wood.

Back cushion structure: in metal.

Upholstery: backrest and seat in polyurethane foam with different densities.

Suspensions: elastic belts in polypropylene and rubber.

Legs: in metal.

Structure: multiplis et bois massif.

Structure coussin de dossier: en métal.

Rembourrage: dossier et assise en mousse de polyuréthane en plusieurs densités.

Suspension: Sangles élastiques en polypropylène et mousse.

Jambes: en métal.

Struktur: vielschichtiges Massivholz.

Rückenkissenstruktur: aus Metall.

Polsterung: Rückenlehne und Sitz aus Polyurethanschaum in unterschiedlichen Dichte.

Federung: elastische Gurte aus Gummi und Polypropylen.

Beine: aus Metall.

Cod. Tessuto/fabric/tissu/Stoff: 1

Cod. Pelle/leather/cuir/Leder: 2

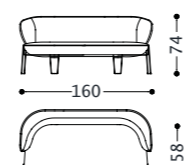
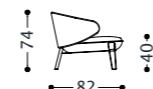

1SWJD2
2SWJD2

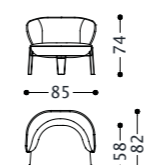

1SWJP
2SWJP

JAMMIN poltrona/armchair/fauteuil/Sessel
elementi/elements/éléments/Elemente

Design by Castello Lagravinese Studio



Struttura portante: multistrato, massello di legno.
Imbottiture: Schienale in poliuretano espanso (densità 21 Kg/mc). Seduta in piuma d'oca con inserto in poliuretano espanso (densità 40 Kg/mc).
Versione fissa: piede in metallo.
Versione girevole: basamento in metallo.

Main structure: Multilayer and solid wood.
Upholstery: Backrest in polyurethane foam (density 21 Kg/mc). Seat in goose feathers with internal padding in polyurethane foam (density 40 Kg/mc).
Fix version: metal feet.
Swivel version: metal base.

Structure: Multiplis et bois massif.
Rembourrage: Dossier en mousse de polyuréthane (densité 21 kg/mc). Assise en plume d'oie avec insert en mousse de polyuréthane (densité 40 kg/mc).
Version fixe: pied en métal.
Version tournante: piétement en métal.

Struktur: vielschichtiges Massivholz.
Polsterung: Rückenlehne aus Polyurethanschaum (Dichte 21 Kg/mc). Sitz aus Gänsedaunen mit Einsatz aus Polyurethanschaum (Dichte 40 Kg/mc).
Fest-Version: Fuß aus Metal.
Dreh-Version: Drehbasis aus Metall.

Cod. Tessuto/fabric/tissu/Stoff: 1
Cod. Pelle/leather/cuir/Leder: 2

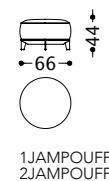
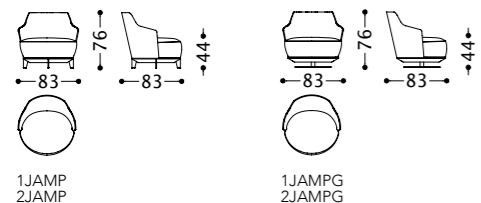

JAMMIN LARGE poltrona/armchair/fauteuil/Sessel
elementi/elements/éléments/Elemente

Design by Castello Lagravinese Studio



Struttura portante: multistrato, massello di legno.
Imbottiture: Schienale in poliuretano espanso (densità 21 Kg/mc). Seduta in piuma d'oca con inserto in poliuretano espanso (densità 40 Kg/mc).
Versione fissa: piede in metallo.
Versione girevole: basamento in metallo.

Main structure: Multilayer and solid wood.
Upholstery: Backrest in polyurethane foam (density 21 Kg/mc). Seat in goose feathers with internal padding in polyurethane foam (density 40 Kg/mc).
Fix version: metal feet.
Swivel version: metal base.

Structure: Multiplis et bois massif.
Rembourrage: Dossier en mousse de polyuréthane (densité 21 kg/mc). Assise en plume d'oie avec insert en mousse de polyuréthane (densité 40 kg/mc).
Version fixe: pied en métal.
Version tournante: piétement en métal.

Struktur: vielschichtiges Massivholz.
Polsterung: Rückenlehne aus Polyurethanschaum (Dichte 21 Kg/mc). Sitz aus Gänsedaunen mit Einsatz aus Polyurethanschaum (Dichte 40 Kg/mc).
Fest-Version: Fuß aus Metal.
Dreh-Version: Drehbasis aus Metall.

Cod. Tessuto/fabric/tissu/Stoff: 1
Cod. Pelle/leather/cuir/Leder: 2

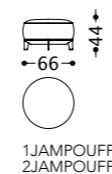
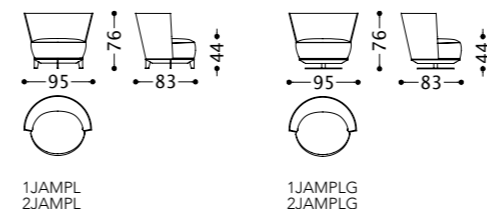

FEENIX 1 TABLE tavolino/small table/table/Couchtisch

elementi/elements/éléments/Elemente

Design by Maurizio Manzoni



Struttura: metallo.
Top: MDF impiallacciato eucalipto frisé e marmo.

Structure: metal.
Top: veneer MDF eucalyptus frisé and marble.

Structure: métal.
Plateau: MDF placage eucalyptus frisé et marbre.

Struktur: Metall.
Top: Holz Eukalyptus Frisé und Marmor.

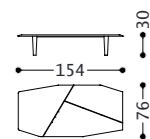

1FE1TAVR

FLYNN 1 • FLYNN 3 • FLYNN 4 • FLYNN 5 • FLYNN 6 tavolino/small table/table/Couchtisch

elementi/elements/éléments/Elemente

Design by Maurizio Manzoni



Struttura: Metallo
Top FLYNN 1: Marmo con sottopiano in MDF verniciato
Top FLYNN 3: MDF laccato
Top FLYNN 4: Ceramica con sottopiano in vetro fumé temperato
Top FLYNN 5: Vetro fumé temperato
Top FLYNN 6: Vetro temperato e serigrafato

Structure: Métal
Top FLYNN 1: Marble with under-top in varnished MDF
Top FLYNN 3: lacquered MDF
Top FLYNN 4: Ceramic with under-top in tempered fumé glass
Top FLYNN 5: Tempered fumé glass
Top FLYNN 6: Tempered serigraphic glass

Structure: Métal
Top FLYNN 1: Marbre avec sous-plateau en MDF verni
Top FLYNN 3: MDF laqué
Top FLYNN 4: Céramique avec sous-plateau en verre fumé tempré
Top FLYNN 5: Verre fumé tempré
Top FLYNN 6: Verre tempré et sérigraphié

Struktur: Metall
Top FLYNN 1: Marmor mit Stütze aus MDF (lackiert)
Top FLYNN 3: MDF (lackiert)
Top FLYNN 4: Keramik mit Stütze aus vorgespanntem Rauchglas
Top FLYNN 5: Vorgespanntes Rauchglas
Top FLYNN 6: Vorgespanntes Glas mit Siebdruck

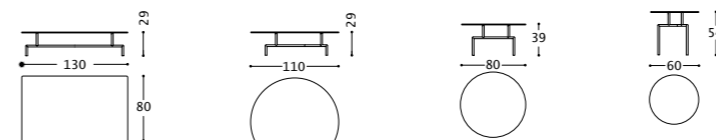

1FL1TAVR
1FL3TAVR
1FL4TAVR
1FL5TAVR
1FL6TAVR

1FL1TROT110
1FL3TROT110
1FL4TROT110
1FL5TROT110
1FL6TROT110

1FL1TROT80
1FL3TROT80
1FL4TROT80
1FL5TROT80
1FL6TROT80

1FL1TROT60
1FL3TROT60
1FL4TROT60
1FL5TROT60
1FL6TROT60

VALERY 1 TABLE tavolino/small table/table/Couchtisch
 elementi/elements/éléments/Elemente

Design by Maurizio Manzoni



Struttura: metallo.
Top: marmo (per tavolino centrale e tavolino rotondo).
Top: marmo e vetro goffrato 10 mm temperato (per consolle).

Structure: metal.
Top: marble (for central small table and round small table).
Top: marble and embossed tempered glass 10 mm (for console).

Structure: métal.
Plateau: marbre (pour table basse centrale et table basse ronde).
Plateau: marbre et verre gaufré 10 mm tempéré (pour consolle).

Struktur: Metall.
Top: Marmor (für zentraler Couchtisch und Rundtisch).
Top: Marmor und vorgespanntem Pressglas 10 mm (für Konsole).

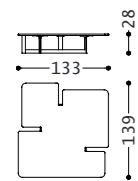

1VL1TAV1

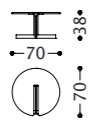

1VL1TROT70

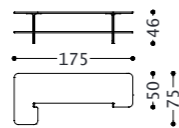

1VL1CONSX

VALERY 3 TABLE tavolino/small table/table/Couchtisch
 elementi/elements/éléments/Elemente

Design by Maurizio Manzoni



Struttura: metallo.
Top: MDF laccato.

Structure: metal.
Top: lacquered MDF.

Structure: métal.
Plateau: MDF laqué.

Struktur: Metall.
Top: MDF lackiert.

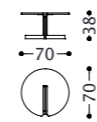

1VL3TAVROT70

ORIGAMI LUXURY GLASS

tavolino/small table/table/Couchtisch

elementi/elements/éléments/Elemente

Design by Maurizio Manzoni



Struttura: metallo.
Top: vetro gofrato 10 mm temperato.

Structure: metal.
Top: embossed tempered glass 10 mm.

Structure: métal.
Plateau: verre gaufré 10 mm tempéré.

Struktur: Metall.
Top: vorgespanntem Pressglas 10 mm.

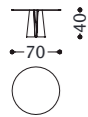

1OL5TAV70

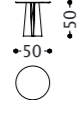

1OL5TAV50

FRISCO

tavolino/small table/table/Couchtisch

elementi/elements/éléments/Elemente

Design by Castello Lagravinese Studio



Struttura: metallica.
Top alto (1): marmo o MDF (laccato).
Top basso (2): MDF (laccato).

Structure: in metal.
Top high (1): marble or MDF (lacquered).
Top low (2): MDF (lacquered).

Structure: en métal.
Plateau haut (1): marbre ou MDF (laqué).
Plateau bas (2): MDF (laqué).

Struktur: aus Metall.
Hoher Top (1): Marmor oder MDF (lackiert).
Niedriger Top (2): MDF (lackiert).



1FRITROT
1FRITROT L



1FRITAVQA
1FRITAVQAL

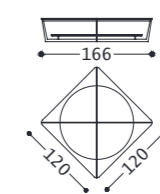

1FRITAVQB
1FRITAVQBL



1FRITAVR
1FRITAVRL

ISLAND tavolino/small table/table/Couchtisch
 elementi/elements/éléments/Elemente

Design by Castello Lagravinese Studio



Struttura: Metallo.
Top: MDF impiallacciato.

Structure: Metal.
Top: Veneer MDF.

Structure: Métal.
Plateau: MDF placage.

Struktur: Metall.
Top: Furniert MDF.

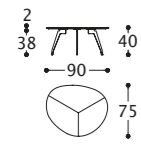

1ISNTSTS40

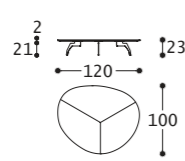

1ISNTMTS23

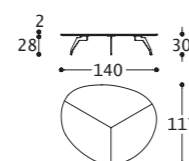

1ISNTLTS30

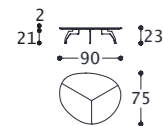

1ISNTST23

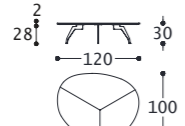

1ISNTMT30

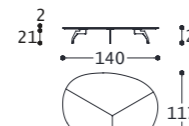

1ISNTLT23

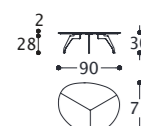

1ISNTST30

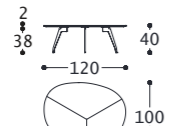

1ISNTMT40

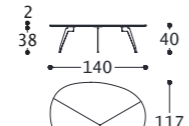

1ISNTLT40

JIMMY 3 tavolino/small table/table/Couchtisch
 elementi/elements/éléments/Elemente

Design by Castello Lagravinese Studio



Struttura: metallica.
Top: MDF (laccato).

Structure: in metal.
Top: MDF (lacquered).

Structure: en métal.
Plateau: MDF (laqué).

Struktur: aus Metall.
Top: MDF (lackiert).

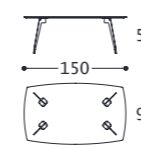

1JI3TAVRH

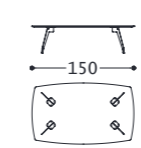

1JI3TAVRM

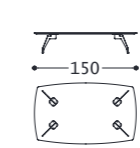

1JI3TAVRL

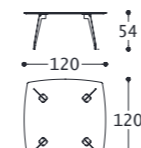

1JI3TAVQ120H

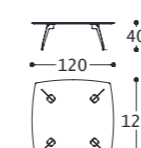

1JI3TAVQ120M

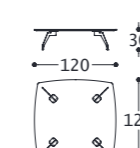

1JI3TAVQ120L

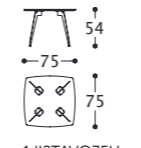

1JI3TAVQ75H

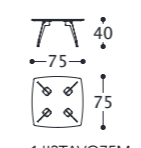

1JI3TAVQ75M

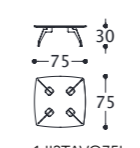

1JI3TAVQ75L



1JI3TAVQ55H



1JI3TAVQ55M



1JI3TAVQ55L

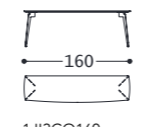

1JI3CO160

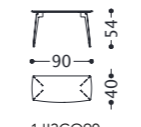

1JI3CO90

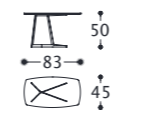

1JI3SER

JAGGER tavolino/small table/table/Couchtisch
elementi/elements/éléments/Elemente

Design by Castello Lagravinese Studio



Struttura: metallica a 5 gambe.
Finitura struttura: laccato.
Top: MDF.
Finitura top: laccato.

Structure: in metal with 5 legs.
Structure finishing: lacquered.
Top: MDF.
Top finishing: lacquered.

Structure: en métal avec 5 jambes.
Finition de la structure: laqué.
Plateau: MDF.
Finition du plateau: laqué.

Struktur: aus Metall mit 5 Beine.
Strukturbearbeitung: lackiert.
Top: MDF.
Topbearbeitung: lackiert.

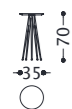

1JAGTH



1JAGTL

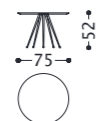

1JAGTM

PHIL tavolino/small table/table/Couchtisch
elementi/elements/éléments/Elemente

Design by Castello Lagravinese Studio



Struttura: metallica.
Top: in marmo o MDF (laccato).

Structure: in metal.
Top: marble or MDF (laquered).

Structure: en métal.
Plateau: marbre ou MDF (laqué).

Struktur: aus Metall.
Top: Marmor oder MDF (lackiert).



1PHISER
1PHISERL





Maurizio Manzoni for:
FLYNN sofa - FEENIX sofa - VALERY sofa
CECILE armchair - SWEET JANE armchair
FEENIX 1 table - FLYNN tables - ORIGAMI LUXURY GLASS table - VALERY tables
VERONIQUE furniture

Castello Lagravinese Studio for:
JAMMIN - JAMMIN LARGE armchair
FRISCO - ISLAND - JAGGER - JIMMY 3 - PHIL tables

Alberta Style Department for:
FREEDOM Sofa
HONOLULU relax armchair
99 pouff



Photography
Emozioni.com
Thomas Pagani

Rendering
Eido

Styling
Luigina Pilloni
Sissi Valassina

Graphic Assistant
Bplus marketing

Special thanks to
Sartori rugs

alberta

via Toniolo 41
31028 Vazzola (TV) - ITALY
T +39 0438 440440
F +39 0438 441555
www.alberta.it

alberta

via Toniolo 41, 31028 Vazzola (TV) - ITALY
www.alberta.it