

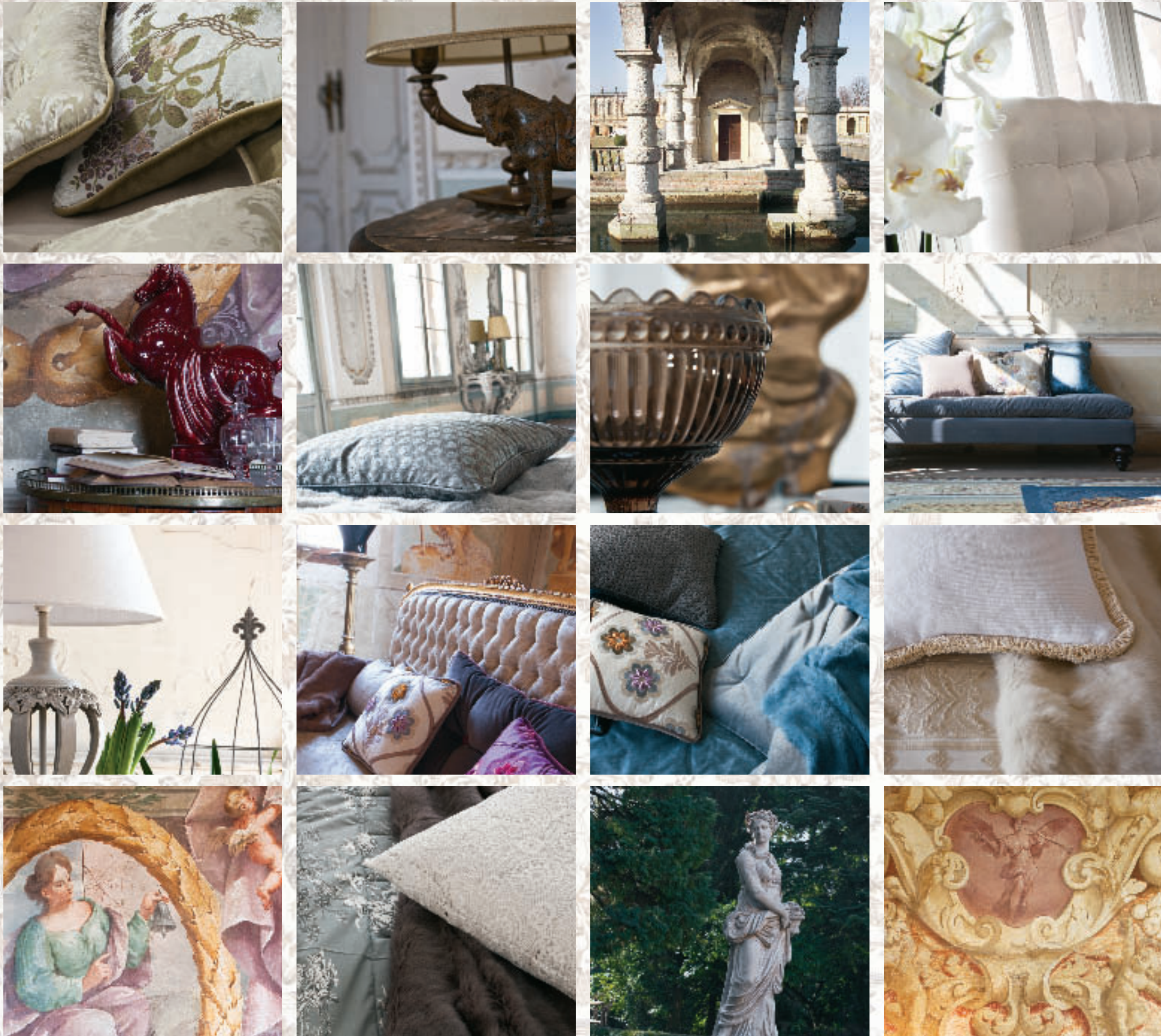

NEW CLASSIC COLLECTION





Twils®

"NEW CLASSIC COLLECTION"

L'AMORE E' LA POESIA DEI SENSI.
O E' SUBLIME O NON C'E'.
QUANDO ESISTE, ESISTE PER SEMPRE E AUMENTA OGNI VOLTA DI PIU'.
HONORE DE BALZAC

CELINE CON GONNA	05	CAMILLE CAPITONNE' ALTO H.28	81
CELINE H.28	09	CAMILLE CON GONNA	85
GIULIETTA H.28	15	GISELLE CON GONNA	93
GIULIETTA FREE H.28	19	GISELLE CON GONNA	97
TOMMY CAPITONNE' CON GONNA	23	MEDEA H.22	99
TOMMY CAPITONNE' H.28	27	ANASTASIA H.28	103
TOMMY CAPITONNE' H.28	29	ANASTASIA CON GONNA	107
GRAND HOTEL H.28	35	MARLENE BOISERIE CON CORNICE	115
DORIAN H.28	39	MARLENE BOISERIE CON CORNICE	117
DORIAN H.28	43	CHOCOLAT H.28	121
GRACE H.28	47	CHOCOLAT H.28	125
GRACE BARRE' H.28	51	LUDWIG H.28	131
GRACE BARRE' H.28	55		
MAX CAPITONNE' CLASSIC BASSO H.28	61		
MAX CAPITONNE' SOFT BASSO H.28	65		
MATISSE H.28	71		
MATISSE H.28	77		



Celine

Design Silvia Prevedello



Twils





Twils



Celine

Design Silvia Prevedello



Romantic World

*Nulla può curare l'anima se non i sensi,
come nulla può curare i sensi se non l'anima*

Oscar Wilde







*Losa è l'amore? ...
È la stella del mattino e
quella della sera.*





Giulietta Lee
Design Antonella Scarpitta



Twils



Tommy capitonné







Tommy capitonné





A CHANGE
TO BE
ROMANTIC

CONSERVA L'AMORE NEL TUO CUORE.
UNA VITA SENZA AMORE
COME UN GIARDINO SENZA SOLE
DOVE I FIORI SONO MORTI.
LA COSCIENZA DI AMARE ED ESSERE AMATI
REGALANO TALE CALORE E RICCHEZZA ALLA VITA
CHE NIENT'ALTRO PUO' PORTARE.

OSCAR WILDE

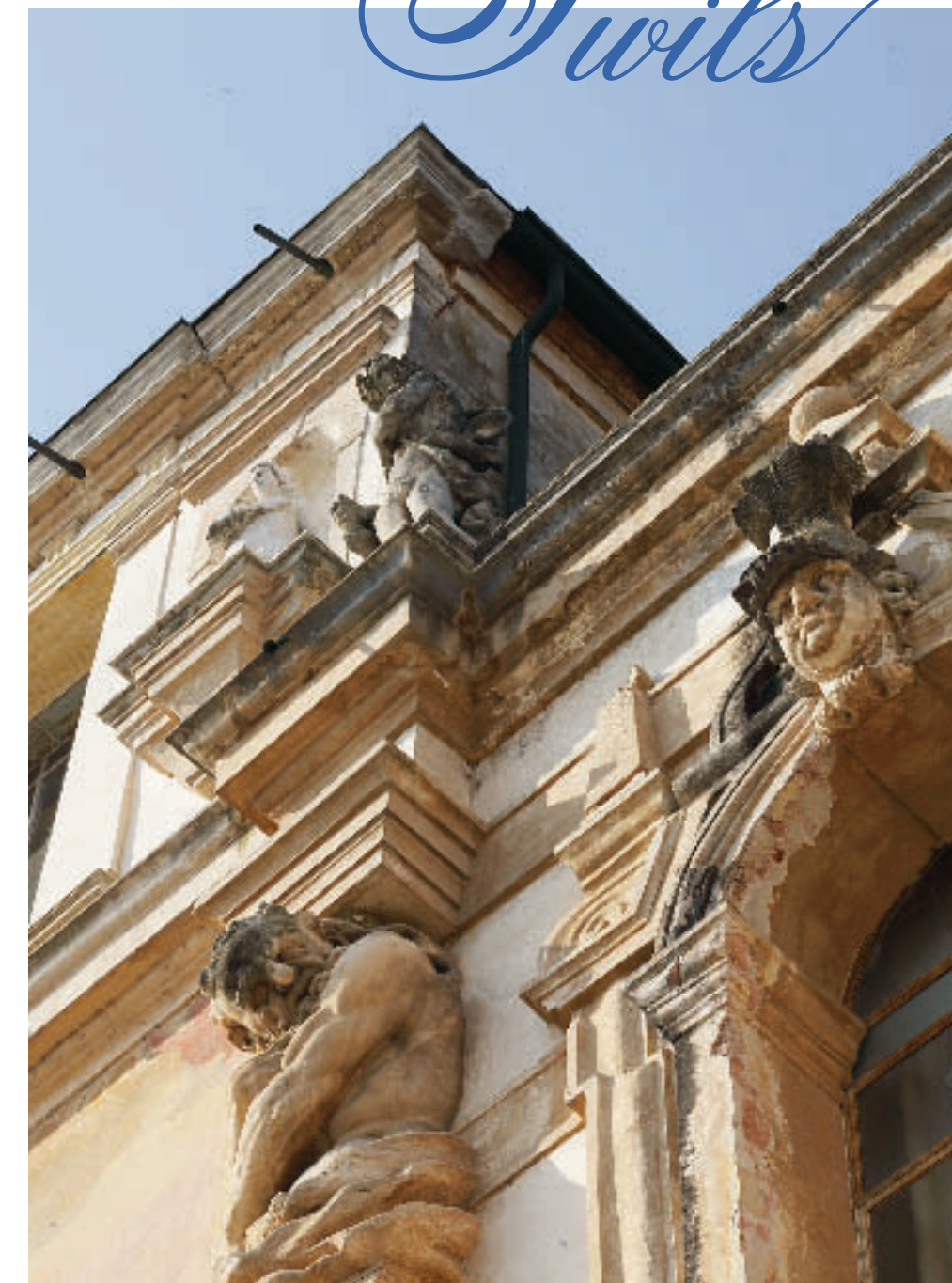
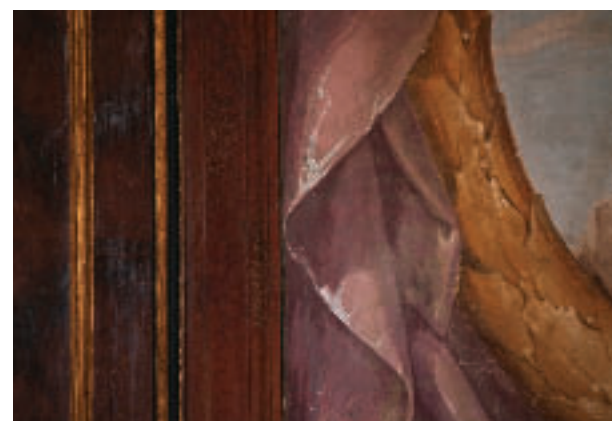

Grand hotel

Design Studio Balutto Associati







Doriana

Design Studio Balutto Associati





Design Studio Balutto Associati

Twils

Doriana





Grace

Design Studio Balutto Associati







Grace latte

Twils



Design Studio Balutto Associati

51



Twils



23

Grace Latté

Design Studio Balutto Associati

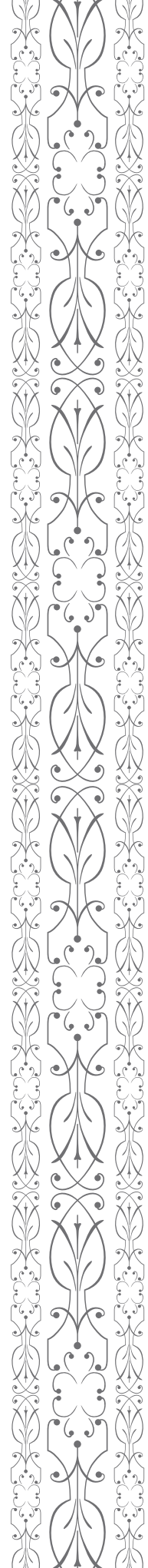









Max capitonné









Matisse











Camille capitonne

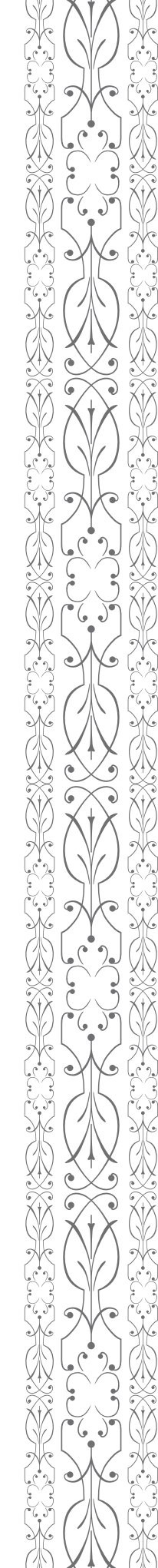







Camille



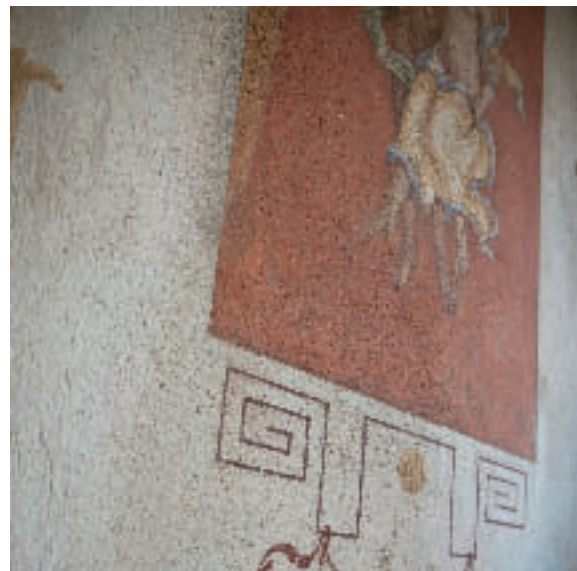

Twils

Sensation and emotion

*I colori, come i lineamenti,
seguono i cambiamenti delle emozioni.*

Pablo Picasso



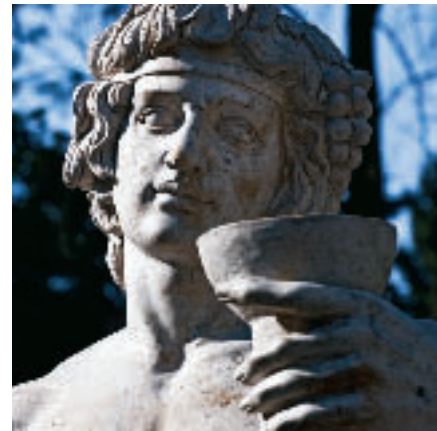

Loveley

*Nulla può curare l'anima se non i sensi
come nulla può curare i sensi se non l'anima*
Oscar Wilde

Giselle



*Époque
classique*



Medea









Romantic feeling
"Amor che nella mente mi ragiona
cominciò egli a dir si dolcemente che
la dolcezza ancor dentro mi suona."

Dante Alighieri





Anastasia



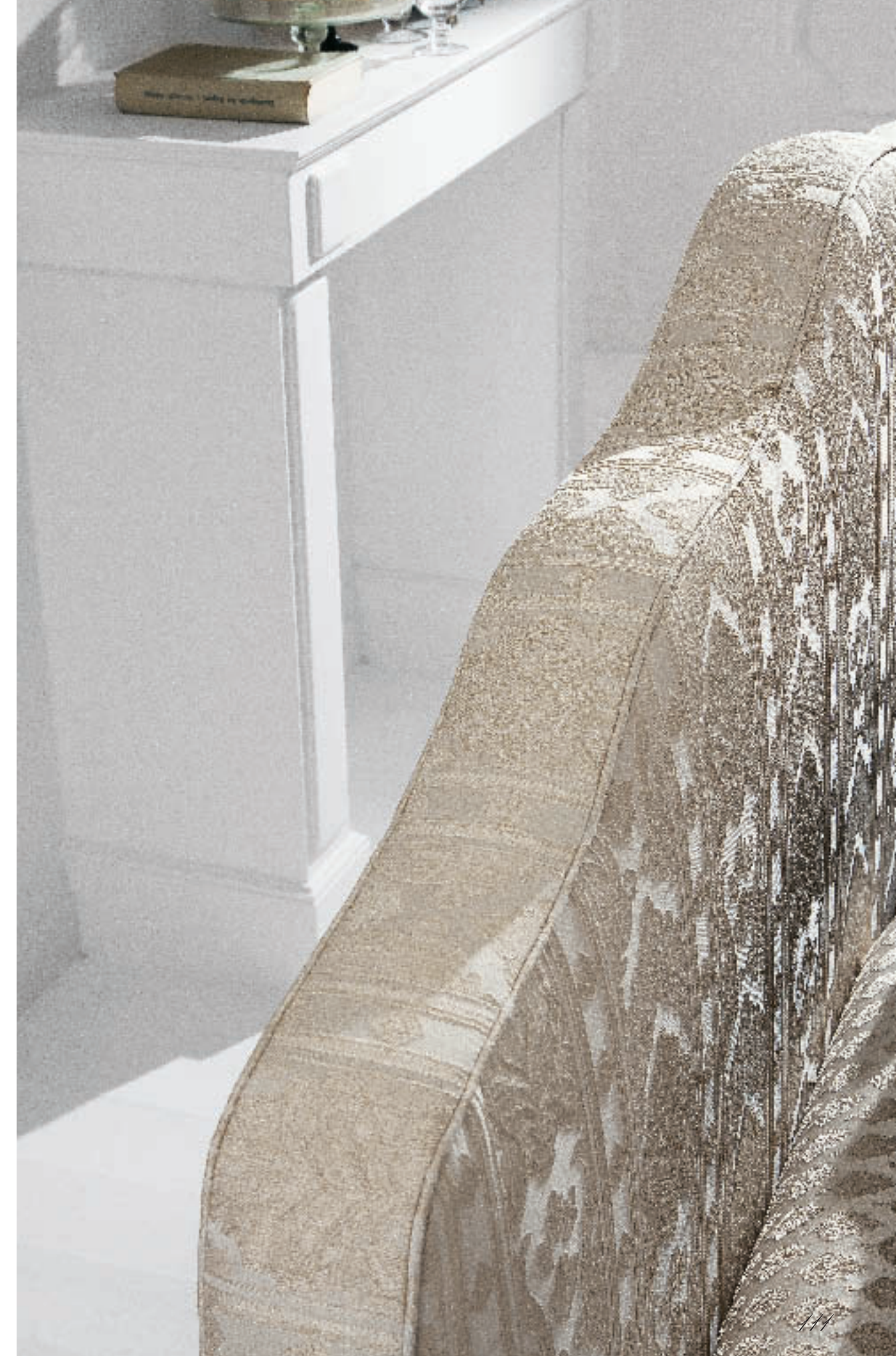





Twils



Marlene Loiserio

Design Silvia Prevedello





Twils





Chocolat















Twils®

TECHNICAL SECTION



Celine con gonna

Pag 5

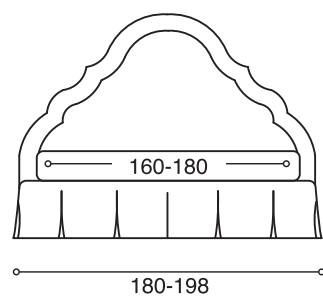
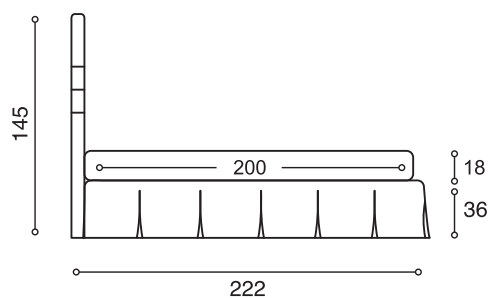

Celine con gonna

- 1 Letto Celine matrimoniale 160x200 c./gonna a faldoni art. A64/002 Cat. Must
- 2 Rollo' con bottone da 80 cm art. A64/001 Cat. Must
- 1 Completo lenzuola matrimoniale da 160 cm art. 990/023 Cat. Raso
- 2 Coprifedera con lacci art. A64/002 Cat. Must
- 1 Piumotto 160x140 cm art. 969/001 Cat. Must
- 1 Piumotto 160x140 cm art. B47/001 Cat. Must
- 1 Plaid pelliccia Lapin 120x180 cm art. 905/040 Cat. E
- 2 Cuscini 50x50 cm mod. T art. 969/001 Cat. Must
- 1 Cuscino 50x30 cm mod. T art. A64/002 Cat. Must
- 1 Cuscino 50x50 cm mod. L art. A64/002 Cat. Must
- 1 Cuscino 50x50 cm mod. Q art. B47/001 Cat. Must
- 1 Poltroncina Zoe art. A64/001 Cat. Must

Celine with skirt

- 1 Double bed Celine 160x200 w/inverted-pleat skirt art. A64/002 Cat. Must
- 2 Roll cushions with button 80 cm art. A64/001 Cat. Must
- 1 Double bed sheet + pillowcase set 160 cm art. 990/023 Cat. Raso
- 2 Pillowcase with laces art. A64/002 Cat. Must
- 1 Duvet 160x140 cm art. 969/001 Cat. Must
- 1 Duvet 160x140 cm art. B47/001 Cat. Must
- 1 Blanket in Lapin fur 120x180 cm art. 905/040 Cat. E
- 2 Cushions 50x50 cm mod. T art. 969/001 Cat. Must
- 1 Cushion 50x30 cm mod. T art. A64/002 Cat. Must
- 1 Cushion 50x50 cm mod. L art. A64/002 Cat. Must
- 1 Cushion 50x50 cm mod. Q art. B47/001 Cat. Must
- 1 Armchair Zoe art. A64/001 Cat. Must

Celine mit Volant

- 1 Doppelbett Celine 160x200 mit Fallenvolant art. A64/002 Cat. Must
- 2 Nackenrollen con Knöpfen 80 cm art. A64/001 Cat. Must
- 1 Bettwäsche-Garnitur für Doppelbett 160 cm art. 990/023 Cat. Raso
- 2 Kissenbezüge mit Bindebändchen art. A64/002 Cat. Must
- 1 Daunendecke 160x140 cm art. 969/001 Cat. Must
- 1 Daunendecke 160x140 cm art. B47/001 Cat. Must
- 1 Plaid aus Kaninfell 120x180 cm art. 905/040 Cat. E
- 2 Kissen 50x50 cm mod. T art. 969/001 Cat. Must
- 1 Kissen 50x30 cm mod. T art. A64/002 Cat. Must
- 1 Kissen 50x50 cm mod. L art. A64/002 Cat. Must
- 1 Kissen 50x50 cm mod. Q art. B47/001 Cat. Must
- 1 Sessel Zoe art. A64/001 Cat. Must

Celine avec cache-sommier

- 1 Lit Celine deux-places 160x200 avec cache-sommier à bords art. A64/002 Cat. Must
- 2 Traversin avec bouton de 80 cm art. A64/001 Cat. Must
- 1 Parure draps lit deux-places de 160 cm art. 990/023 Cat. Raso
- 2 Taie d'oreiller avec lacets art. A64/002 Cat. Must
- 1 Couette 160x140 cm art. 969/001 Cat. Must
- 1 Couette 160x140 cm art. B47/001 Cat. Must
- 1 Plaid peau Lapin 120x180 cm art. 905/040 Cat. E
- 2 Oreillers 50x50 cm mod. T art. 969/001 Cat. Must
- 1 Oreiller 50x30 cm mod. T art. A64/002 Cat. Must
- 1 Oreiller 50x50 cm mod. L art. A64/002 Cat. Must
- 1 Oreiller 50x50 cm mod. Q art. B47/001 Cat. Must
- 1 Fauteuil Zoe art. A64/001 Cat. Must



Celine h.28

Pag 9

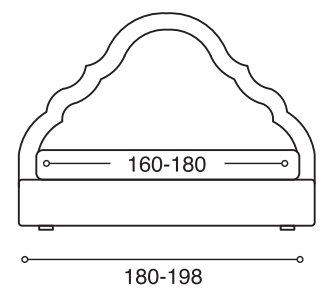
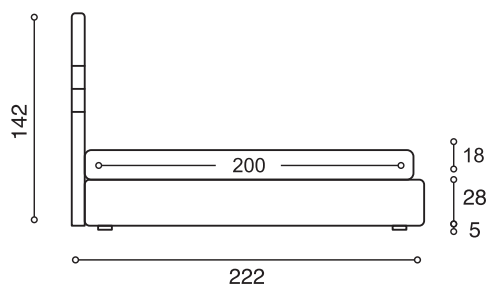

Celine h.28

- 1 Letto Celine matrimoniale 180x200 h.28 Pannello piede PIE2PA art. A64/019 Cat. Must
- 1 Completo lenzuola matrimoniale da 180 cm art. B46/005 Cat. Must
- 1 Copriletto liscio matrimoniale da 180 cm art. 990/012 Cat. Raso
- 1 Quilt trapuntato 30x30 matrimoniale da 180 cm art. A85/003 Cat. Giudecca
- 2 Rollo' c./cerniera e bordo rivestito da 90 cm art. B46/005 Cat. Must
- 1 Plaid pelliccia Lapin 120x180 cm art. 969/054 Cat. Must
- 1 Cuscino 70x40 cm mod. B con bottoni bordo e bottoni art. 905/037 Cat. E
- 1 Cuscino 70x40 cm mod. B con bottoni bordo e bottoni art. 969/054 Cat. Must
- 1 Cuscino 70x40 cm mod. B con bottoni bordo e bottoni art. B43/007 Cat. Must
- 1 Cuscino 45x45 cm mod. B art. B43/007 Cat. Must
- 1 Cuscino 60x60 cm mod. B art. B46/005 Cat. Must
- 1 Pouf rotondo Ø 70 cm art. B52/011 Cat. E
- 1 Cuscino 70x40 cm mod. B con bottoni bordo e bottoni art. 969/054 Cat. Must
- 1 Cuscino 70x40 cm mod. B con bottoni bordo e bottoni art. B43/007 Cat. Must
- 1 Cuscino 45x45 cm mod. B art. B46/005 Cat. Must
- 1 Cuscino 60x60 cm mod. B art. B52/011 Cat. E
- 1 Round pouf Ø 70 cm art. 969/062 Cat. Must

Celine h.28

- 1 Double bed Celine 180x200 h.28 Panel foot PIE2PA art. A64/019 Cat. Must
- 1 Double bed sheet + pillowcase set 180 cm art. B46/005 Cat. Must
- 1 Plain double bedspread 180 cm art. 990/012 Cat. Raso
- 1 Quilt trapuntato 30x30 matrimoniale da 180 cm art. A85/003 Cat. Giudecca
- 2 Roll cushions with zipper and double-pleat edge 90 cm art. B46/005 Cat. Must
- 1 Blanket in Lapin fur 120x180 cm art. 969/054 Cat. Must
- 1 Cushion 70x40 cm mod. B with buttons Edge and buttons art. 905/037 Cat. E
- 1 Cushion 70x40 cm mod. B with buttons Edge and buttons art. 969/054 Cat. Must
- 1 Cushion 70x40 cm mod. B with buttons Edge and buttons art. B43/007 Cat. Must
- 1 Cushion 45x45 cm mod. B art. B43/007 Cat. Must
- 1 Cushion 60x60 cm mod. B art. B46/005 Cat. Must
- 1 Round pouf Ø 70 cm art. B52/011 Cat. E

Celine h.28

- 1 Doppelbett Celine 180x200 h.28 Paneel Fuß PIE2PA art. A64/019 Cat. Must
- 1 Glatte Tagesdecke für Doppelbett 180 cm art. B46/005 Cat. Must
- 1 Gestepppter Quilt 30x30 für Doppelbett 180 cm art. 969/054 Cat. Must
- 2 Nackenrollen mit Reißverschluss und mit bezogenem Rand 90 cm art. 905/037 Cat. E
- 1 Plaid aus Kaninfell 120x180 cm art. 969/054 Cat. Must
- 1 Kissen 70x40 cm mod. B mit Knöpfen Rand und Knöpfen art. B43/007 Cat. Must
- 1 Kissen 70x40 cm mod. B mit Knöpfen Rand und Knöpfen art. B43/007 Cat. Must
- 1 Kissen 45x45 cm mod. B art. 969/054 Cat. Must
- 1 Kissen 60x60 cm mod. B art. B46/005 Cat. Must
- 1 Runde Pouf Ø 70 cm art. B52/011 Cat. E

Celine h.28

- 1 Lit Celine deux-places 180x200 h.28 Panneau Pied PIE2PA art. A64/019 Cat. Must
- 1 Couvre-lit lisse deux-places de 180 cm art. B46/005 Cat. Must
- 1 Quilt surpiqué 30x30 lit deux-places de 180 cm art. 990/012 Cat. Raso
- 2 Traversin avec fermeture éclair et bord revêtu de 90 cm art. A85/003 Cat. Giudecca
- 1 Plaid peau Lapin 120x180 cm art. B46/005 Cat. Must
- 1 Oreiller 70x40 cm mod. B avec boutons bord et boutons art. 905/037 Cat. E
- 1 Oreiller 70x40 cm mod. B avec boutons bord et boutons art. 969/054 Cat. Must
- 1 Oreiller 45x45 cm mod. B art. B43/007 Cat. Must
- 1 Oreiller 60x60 cm mod. B art. 969/054 Cat. Must
- 1 Pouf rond Ø 70 cm art. B46/005 Cat. Must



Giulietta h.28

Pag 15

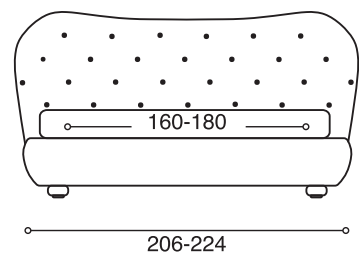
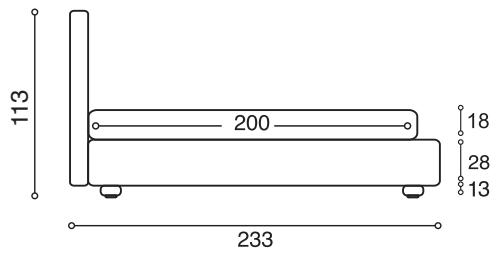

Giulietta h.28

- 1 Letto Giulietta 160x200 h.28 bordo e bottoni piede PIE4BV art. 969/062 Cat. Must
- 1 Copriletto liscio matrimoniale da 160 cm art. 969/062 Cat. Must
- 1 Piumotto 160x140 cm art. 969/054 Cat. Must
- 1 Plaid pelliccia Lapin 120x180 cm art. 905/018 Cat. E
- 1 Plaid pelliccia Lapin 120x180 cm art. 905/037 Cat. E
- 1 Cuscino 70x40 cm mod. T c./bottoni art. 969/054 Cat. Must
- 1 Cuscino 45x45 cm mod. B art. 969/010 Cat. Must
- 1 Cuscino 50x30 cm mod. B art. 969/010 Cat. Must
- 1 Cuscino 45x45 cm mod. B art. 969/053 Cat. Must
- 1 Cuscino 50x50 cm mod. B art. B43/007 Cat. Must
- 1 Sedia Coco' gonna lunga e fiocco art. 969/027 Cat. Must

Giulietta h.28

- 1 Double bed Giulietta 160x200 h.28 Edge and buttons footPIE4BV art. 969/062 Cat. Must
- 1 Plain double bedspread 160 cm art. 969/062 Cat. Must
- 1 Duvet 160x140 cm art. 969/054 Cat. Must
- 1 Blanket in Lapin fur 120x180 cm art. 905/018 Cat. E
- 1 Blanket in Lapin fur 120x180 cm art. 905/037 Cat. E
- 1 Cushion 70x40 cm mod. T w./buttons art. 969/054 Cat. Must
- 1 Cushion 45x45 cm mod. B art. 969/010 Cat. Must
- 1 Cushion 50x30 cm mod. B art. 969/010 Cat. Must
- 1 Cushion 45x45 cm mod. B art. 969/053 Cat. Must
- 1 Cushion 50x50 cm mod. B art. B43/007 Cat. Must
- 1 Chair Coco' long skirt and ribbon art. 969/027 Cat. Must

Giulietta h.28

- 1 Bett Giulietta 160x200 h.28 Rand und Knöpfe Fuß PIE4BV art. 969/062 Cat. Must
- 1 Glatte Tagesdecke für Doppelbett 160 cm art. 969/062 Cat. Must
- 1 Daunendecke 160x140 cm art. 969/054 Cat. Must
- 1 Plaid aus Kaninfell 120x180 cm art. 905/018 Cat. E
- 1 Plaid aus Kaninfell 120x180 cm art. 905/037 Cat. E
- 1 Kissen 70x40 cm mod. T m./Knöpfen art. 969/054 Cat. Must
- 1 Kissen 45x45 cm mod. B art. 969/010 Cat. Must
- 1 Kissen 50x30 cm mod. B art. 969/010 Cat. Must
- 1 Kissen 45x45 cm mod. B art. 969/053 Cat. Must
- 1 Kissen 50x50 cm mod. B art. B43/007 Cat. Must
- 1 Stuhl Coco' mit langem Volant und Schleife art. 969/027 Cat. Must

Giulietta h.28

- 1 Lit Giulietta 160x200 h.28 bord et boutons Pied PIE4BV art. 969/062 Cat. Must
- 1 Couvre-lit lisse deux-places de 160 cm art. 969/062 Cat. Must
- 1 Couette 160x140 cm art. 969/054 Cat. Must
- 1 Plaid peau Lapin 120x180 cm art. 905/018 Cat. E
- 1 Plaid peau Lapin 120x180 cm art. 905/037 Cat. E
- 1 Oreiller 70x40 cm mod. T c./boutons art. 969/054 Cat. Must
- 1 Oreiller 45x45 cm mod. B art. 969/010 Cat. Must
- 1 Oreiller 50x30 cm mod. B art. 969/010 Cat. Must
- 1 Oreiller 45x45 cm mod. B art. 969/053 Cat. Must
- 1 Oreiller 50x50 cm mod. B art. B43/007 Cat. Must
- 1 Chaise Coco' couvre-sommier long et noué art. 969/027 Cat. Must



Giulietta Free h.28

Pag 19

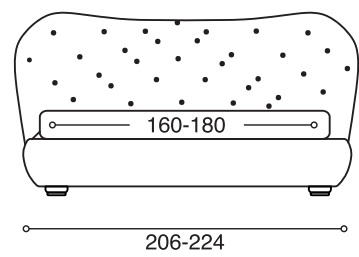
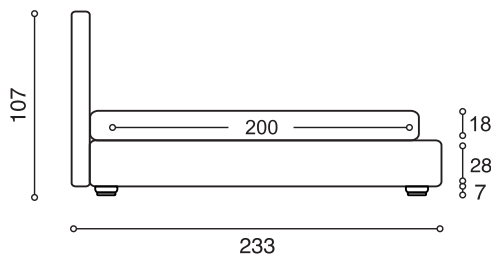

Giulietta Free h.28

- 1 Letto Giulietta Free matrimoniale 160x200 h.28 box piede PIE29O art. 969/003 Cat. Must
- 2 Rollo con cerniera e bordo rivestito da 80 cm art. 969/054 Cat. Must
- 1 Copriletto liscio matrimoniale da 160 cm art. B43/003 Cat. Must
- 1 Quilt trapuntato 15x15 matrimoniale da 160 cm art. B49/001 Cat. Must
- 1 Piumotto 160x140 cm art. 969/054 Cat. Must
- 1 Cuscino 60x60 cm mod. T art. 900/002 Cat. Must
- 1 Cuscino 60x60 cm mod. B art. 969/003 Cat. Must
- 1 Cuscino 50x30 cm mod. B art. 969/004 Cat. Must
- 1 Cuscino Tondo Super con bottone art. B43/002 Cat. Must
- 1 Poltrona Kondi aperta art. 969/054 Cat. Must

Giulietta Free h.28

- 1 Double bed Giulietta Free 160x200 h.28 box foot PIE29O art. 969/003 Cat. Must
- 2 Roll cushions with zipper and double-pleat edge 80 cm art. 969/054 Cat. Must
- 1 Plain double bedspread 160 cm art. B43/003 Cat. Must
- 1 Double quilt 15x15 160 cm art. B49/001 Cat. Must
- 1 Duvet 160x140 cm art. 969/054 Cat. Must
- 1 Cushion 60x60 cm mod. T art. 900/002 Cat. Must
- 1 Cushion 60x60 cm mod. B art. 969/003 Cat. Must
- 1 Cushion 50x30 cm mod. B art. 969/004 Cat. Must
- 1 Round cushion Super with button art. B43/002 Cat. Must
- 1 Armchair Kondi open art. 969/054 Cat. Must

Giulietta Free h.28

- 1 Doppelbett Giulietta Free 160x200 h.28 box Fuß PIE29O art. 969/003 Cat. Must
- 2 Nackenrollen mit Reißverschluss und mit bezogenem Rand da 80 cm art. 969/054 Cat. Must
- 1 Glatte Tagesdecke für Doppelbett 160 cm art. B43/003 Cat. Must
- 1 Gestepppter Quilt 15x15 für Doppelbett 160 cm art. B49/001 Cat. Must
- 1 Daunendecke 160x140 cm art. 969/054 Cat. Must
- 1 Kissen 60x60 cm mod. T art. 900/002 Cat. Must
- 1 Kissen 60x60 cm mod. B art. 969/003 Cat. Must
- 1 Kissen 50x30 cm mod. B art. 969/004 Cat. Must
- 1 Runde Kissen Super mit Knopf art. B43/002 Cat. Must
- 1 Offener Sessel Kondi art. 969/054 Cat. Must

Giulietta Free h.28

- 1 Lit Giulietta Free deux-places 160x200 h.28 box Pied PIE29O art. 969/003 Cat. Must
- 2 Traversin avec fermeture éclair et bord revêtu de 80 cm art. 969/054 Cat. Must
- 1 Couvre-lit lisse deux-places de 160 cm art. B43/003 Cat. Must
- 1 Quilt surpiqué 15x15 deux-places de 160 cm art. B49/001 Cat. Must
- 1 Couette 160x140 cm art. 969/054 Cat. Must
- 1 Oreiller 60x60 cm mod. T art. 900/002 Cat. Must
- 1 Oreiller 60x60 cm mod. B art. 969/003 Cat. Must
- 1 Oreiller 50x30 cm mod. B art. 969/004 Cat. Must
- 1 Oreiller Rond Super avec bouton art. B43/002 Cat. Must
- 1 Fauteuil Kondi ouvert art. 969/054 Cat. Must



Tommy Capitoné con gonna

Pag 23

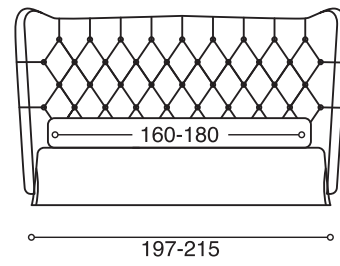
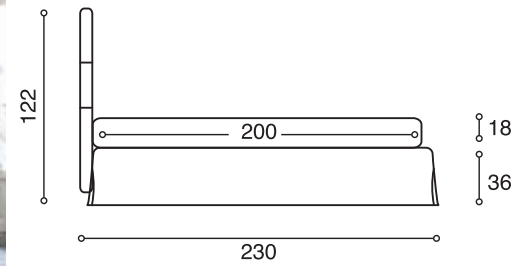

Tommy Capitoné con gonna

- | | | |
|---|--------------|-------------|
| 1 Letto Tommy Capitoné matrimoniale 160x200 con gonna | art. 843/002 | Cat. E Plus |
| 2 Rollò con cerniera da 80 cm | art. 843/002 | Cat. E Plus |
| 1 Trapunta matrimoniale da 160 cm trapuntata baguette | art. 843/011 | Cat. Must |
| 1 Copriletto liscio matrimoniale da 160 cm | art. 843/002 | Cat. Must |
| 1 Plaid pelliccia Lapin 120x180 cm | art. 905/015 | Cat. E |
| 1 Cuscino 60x60 cm mod. T | art. 900/002 | Cat. Must |
| 1 Cuscino 60x60 cm mod. Q | art. 849/001 | Cat. Must |
| 1 Cuscino 50x30 cm mod. Q | art. 969/003 | Cat. Must |
| 1 Cuscino 50x30 cm mod. B | art. 843/011 | Cat. Must |
| 1 Cuscino 50x30 cm mod. B con bottoni | art. A38/027 | Cat. C |
| bordo rivestito e bottoni | art. 969/033 | Cat. Must |
| 1 Table habillé' | art. 969/028 | Cat. Must |
| 1 Poltrona Velvet | art. 969/028 | Cat. Must |
| bordo rivestito | art. 969/033 | Cat. Must |

Tommy Capitoné with skirt

- | | | |
|--|--------------|-------------|
| 1 Doubl ebed Tommy Capitoné 160x200 with skirt | art. 843/002 | Cat. E Plus |
| 2 Roll cushions with zipper da 80 cm | art. 843/002 | Cat. E Plus |
| 1 Double-bed quilt 160 cm baguette quilting | art. B43/011 | Cat. Must |
| 1 Plain double bedspread 160 cm | art. B43/002 | Cat. Must |
| 1 Blanket in Lapin fur 120x180 cm | art. 905/015 | Cat. E |
| 1 Cushion 60x60 cm mod. T | art. 900/002 | Cat. Must |
| 1 Cushion 60x60 cm mod. Q | art. B49/001 | Cat. Must |
| 1 Cushion 50x30 cm mod. Q | art. 969/003 | Cat. Must |
| 1 Cushion 50x30 cm mod. B | art. B43/011 | Cat. Must |
| 1 Cushion 50x30 cm mod. B with buttons | art. A38/027 | Cat. C |
| with double-pleat edge and buttons | art. 969/033 | Cat. Must |
| 1 Table habillé' | art. 969/028 | Cat. Must |
| 1 Armchair Velvet | art. 969/028 | Cat. Must |
| with double-pleat edge | art. 969/033 | Cat. Must |

Tommy Capitoné mit Volant

- | | | |
|---|--------------|-------------|
| 1 Doppelbett Tommy Capitoné 160x200 mit Volant | art. 843/002 | Cat. E Plus |
| 2 Nackenrollen mit Reißverschluss 80 cm | art. 843/002 | Cat. E Plus |
| 1 Steppdecke für Doppelbett 160 cm Doppelnahtsteppung | art. B43/011 | Cat. Must |
| 1 Glatte Tagesdecke für Doppelbett 160 cm | art. 843/002 | Cat. Must |
| 1 Plaid aus Kaninfell 120x180 cm | art. 905/015 | Cat. E |
| 1 Kissen 60x60 cm mod. T | art. 900/002 | Cat. Must |
| 1 Kissen 60x60 cm mod. Q | art. B49/001 | Cat. Must |
| 1 Kissen 50x30 cm mod. Q | art. 969/003 | Cat. Must |
| 1 Kissen 50x30 cm mod. B | art. B43/011 | Cat. Must |
| 1 Kissen 50x30 cm mod. B mit Knöpfen | art. A38/027 | Cat. C |
| mit bezogenem Rand und Knöpfen | art. 969/033 | Cat. Must |
| 1 Table habillé' | art. 969/028 | Cat. Must |
| 1 Sessel Velvet | art. 969/028 | Cat. Must |
| mit bezogenem Rand | art. 969/033 | Cat. Must |

Tommy Capitoné avec couvre-sommier

- | | | |
|--|--------------|-------------|
| 1 Lit Tommy Capitoné deux-places 160x200 avec couvre-sommier | art. 843/002 | Cat. E Plus |
| 2 Traversin avec fermeture éclair de 80 cm | art. 843/002 | Cat. E Plus |
| 1 Courtrepointe deux-places de 160 cm surpiquée baguette | art. B43/011 | Cat. Must |
| 1 Couvre-lit lisse deux-places de 160 cm | art. 843/002 | Cat. Must |
| 1 Plaid peau Lapin 120x180 cm | art. 905/015 | Cat. E |
| 1 Oreiller 60x60 cm mod. T | art. 900/002 | Cat. Must |
| 1 Oreiller 60x60 cm mod. Q | art. B49/001 | Cat. Must |
| 1 Oreiller 50x30 cm mod. Q | art. 969/003 | Cat. Must |
| 1 Oreiller 50x30 cm mod. B | art. B43/011 | Cat. Must |
| 1 Oreiller 50x30 cm mod. B avec boutons | art. A38/027 | Cat. C |
| bord revêtu et boutons | art. 969/033 | Cat. Must |
| 1 Table habillée' | art. 969/028 | Cat. Must |
| 1 Fauteuil Velvet | art. 969/028 | Cat. Must |
| bord revêtu | art. 969/033 | Cat. Must |



Tommy Capitoné h.28

Pag 27

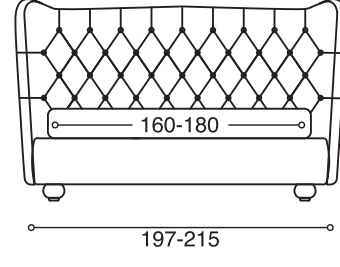
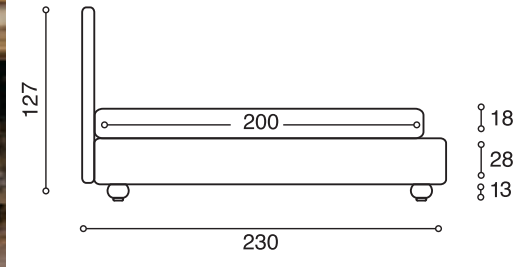

Tommy Capitoné h.28

- | | | |
|---|--------------|-------------|
| 1 Letto Tommy Capitoné matrimoniale 160x200 h.28 piedi PIE48V | art. 843/002 | Cat. E Plus |
| 2 Rollò con cerniera da 80 cm | art. 843/002 | Cat. E Plus |
| 1 Completo lenzuola matrimoniale da 160 cm | art. 990/012 | Cat. Raso |
| 1 Piumotto 140x160 cm | art. 969/028 | Cat. Must |
| 1 Plaid pelliccia Lapin 120x180 cm | art. 905/016 | Cat. E |
| 1 Copriletto liscio matrimoniale da 160 cm | art. 969/062 | Cat. Must |
| 1 Cuscino 70x40 cm mod. B con bottoni | art. 969/054 | Cat. Must |
| bordo rivestito e bottoni | art. B43/007 | Cat. Must |
| 1 Cuscino 50x30 cm mod. Q | art. 969/003 | Cat. Must |

Tommy Capitoné h.28

- | | | |
|--|--------------|-------------|
| 1 Double bed Tommy Capitoné 160x200 h.28 feet PIE48V | art. 843/002 | Cat. E Plus |
| 2 Roll cushions with zipper da 80 cm | art. 843/002 | Cat. E Plus |
| 1 Double bed sheet + pillowcase set 160 cm | art. 990/012 | Cat. Raso |
| 1 Duvet 140x160 cm | art. 969/028 | Cat. Must |
| 1 Blanket in Lapin fur 120x180 cm | art. 905/016 | Cat. E |
| 1 Plain double bedspread 160 cm | art. 969/062 | Cat. Must |
| 1 Cushion 70x40 cm mod. B with buttons | art. 969/054 | Cat. Must |
| with double-pleat edge and buttons | art. B43/007 | Cat. Must |
| 1 Cushion 50x30 cm mod. Q | art. 969/003 | Cat. Must |

Tommy Capitoné h.28

- | | | |
|--|--------------|-------------|
| 1 Doppelbett Tommy Capitoné 160x200 h.28 FüÙe PIE48V | art. 843/002 | Cat. E Plus |
| 2 Nackenrollen mit Reißverschluss 80 cm | art. 843/002 | Cat. E Plus |
| 1 BettwäÙche-Garnitur für Doppelbett 160 cm | art. 990/012 | Cat. Raso |
| 1 Daunendecke 140x160 cm | art. 969/028 | Cat. Must |
| 1 Plaid aus Kaninfell 120x180 cm | art. 905/016 | Cat. E |
| 1 Glatte Tagesdecke für Doppelbett 160 cm | art. 969/062 | Cat. Must |
| 1 Kissen 70x40 cm mod. B mit Knöpfen | art. 969/054 | Cat. Must |
| mit bezogenem Rand und Knöpfen | art. B43/007 | Cat. Must |
| 1 Kissen 50x30 cm mod. Q | art. 969/003 | Cat. Must |

Tommy Capitoné h.28

- | | | |
|--|--------------|-------------|
| 1 Lit Tommy Capitoné deux-places 160x200 h.28 pieds PIE48V | art. 843/002 | Cat. E Plus |
| 2 Traversin avec fermeture éclair de 80 cm | art. 843/002 | Cat. E Plus |
| 1 Parure draps deux-places de 160 cm | art. 990/012 | Cat. Raso |
| 1 Couette 140x160 cm | art. 969/028 | Cat. Must |
| 1 Plaid peau Lapin 120x180 cm | art. 905/016 | Cat. E |
| 1 Couvre-lit lisse deux-places de 160 cm | art. 969/062 | Cat. Must |
| 1 Oreiller 70x40 cm mod. B avec boutons | art. 969/054 | Cat. Must |
| bord revêtu et boutons | art. B43/007 | Cat. Must |
| 1 Oreiller 50x30 cm mod. Q | art. 969/003 | Cat. Must |



Tommy Capitoné h.28

Pag 29

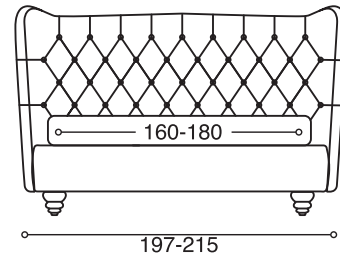
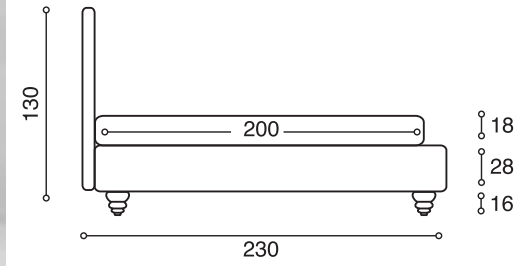

Tommy Capitoné h.28

- | | | |
|---|--------------|-----------|
| 1 Letto Tommy Capitoné matrimoniale 160x200 h.28 bottoni piedi PIE64V | art. 969/028 | Cat. Must |
| 2 Rollò con cerniera e bordo rivestito da 80 cm | art. 969/033 | Cat. Must |
| 1 Completo copripiumino matrimoniale da 160 cm | art. 990/023 | Cat. Raso |
| 1 Piumotto 140x160 cm | art. 969/028 | Cat. Must |
| 1 Piumotto 140x160 cm | art. 969/051 | Cat. Must |
| 1 Plaid pelliccia Lapin 120x180 cm | art. 905/020 | Cat. E |
| 1 Cuscino 70x40 cm mod. B | art. B43/010 | Cat. Must |
| 1 Cuscino 50x50 cm mod. B | art. 969/010 | Cat. Must |
| 1 Cuscino 50x30 cm mod. B | art. 969/031 | Cat. Must |
| 1 Cuscino 50x50 cm mod. B | art. 969/028 | Cat. Must |
| bordo rivestito | art. 969/033 | Cat. Must |
| 1 Pouf rotondo ø 60 cm | art. 969/027 | Cat. Must |
| 1 Pouf rotondo ø 60 cm | art. B45/003 | Cat. E |

Tommy Capitoné h.28

- | | | |
|--|--------------|-----------|
| 1 Double bed Tommy Capitoné 160x200 h.28 buttons feet PIE64V | art. 969/028 | Cat. Must |
| 2 Roll cushions with zipper and double-pleat edge 80 cm | art. 969/033 | Cat. Must |
| 1 Duvet cover + 2 pillowcases 160 cm | art. 990/023 | Cat. Raso |
| 1 Duvet 140x160 cm | art. 969/028 | Cat. Must |
| 1 Duvet 140x160 cm | art. 969/051 | Cat. Must |
| 1 Blanket in Lapin fur 120x180 cm | art. 905/020 | Cat. E |
| 1 Cushion 70x40 cm mod. B | art. B43/010 | Cat. Must |
| 1 Cushion 50x50 cm mod. B | art. 969/010 | Cat. Must |
| 1 Cushion 50x30 cm mod. B | art. 969/031 | Cat. Must |
| 1 Cushion 50x50 cm mod. B | art. 969/028 | Cat. Must |
| with double-pleat edge | art. 969/033 | Cat. Must |
| 1 Round pouf ø 60 cm | art. 969/027 | Cat. Must |
| 1 Round pouf ø 60 cm | art. B45/003 | Cat. E |

Tommy Capitoné h.28

- | | | |
|--|--------------|-----------|
| 1 Doppelbett Tommy Capitoné 160x200 h.28 Knöpfen FüÙe PIE64V | art. 969/028 | Cat. Must |
| 2 Nackenrollen mit Reißverschluss und bezogenem Rand 80 cm | art. 969/033 | Cat. Must |
| 1 Garnitur mit Federbettbezügen für Doppelbett 160 cm | art. 990/023 | Cat. Raso |
| 1 Daunendecke 140x160 cm | art. 969/028 | Cat. Must |
| 1 Daunendecke 140x160 cm | art. 969/051 | Cat. Must |
| 1 Plaid aus Kaninfell 120x180 cm | art. 905/020 | Cat. E |
| 1 Kissen 70x40 cm mod. B | art. B43/010 | Cat. Must |
| 1 Kissen 50x50 cm mod. B | art. 969/010 | Cat. Must |
| 1 Kissen 50x30 cm mod. B | art. 969/031 | Cat. Must |
| 1 Kissen 50x50 cm mod. B | art. 969/028 | Cat. Must |
| mit bezogenem Rand | art. 969/033 | Cat. Must |
| 1 Runder Pouf ø 60 cm | art. 969/027 | Cat. Must |
| 1 Runder Pouf ø 60 cm | art. B45/003 | Cat. E |

Tommy Capitoné h.28

- | | | |
|--|--------------|-----------|
| 1 Lit Tommy Capitoné deux-places 160x200 h.28 boutons pieds PIE64V | art. 969/028 | Cat. Must |
| 2 Traversin avec fermeture éclair et bord revêtu de 80 cm | art. 969/033 | Cat. Must |
| 1 Parure housse de couette deux-places de 160 cm | art. 990/023 | Cat. Raso |
| 1 Couette 140x160 cm | art. 969/028 | Cat. Must |
| 1 Couette 140x160 cm | art. 969/051 | Cat. Must |
| 1 Plaid peau Lapin 120x180 cm | art. 905/020 | Cat. E |
| 1 Oreiller 70x40 cm mod. B | art. B43/010 | Cat. Must |
| 1 Oreiller 50x50 cm mod. B | art. 969/010 | Cat. Must |
| 1 Oreiller 50x30 cm mod. B | art. 969/031 | Cat. Must |
| 1 Oreiller 50x50 cm mod. B | art. 969/028 | Cat. Must |
| bord revêtu | art. 969/033 | Cat. Must |
| 1 Pouf rond ø 60 cm | art. 969/027 | Cat. Must |
| 1 Pouf rond ø 60 cm | art. B45/003 | Cat. E |



Grand Hotel h.22

Pag 35

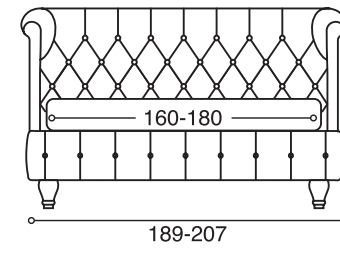
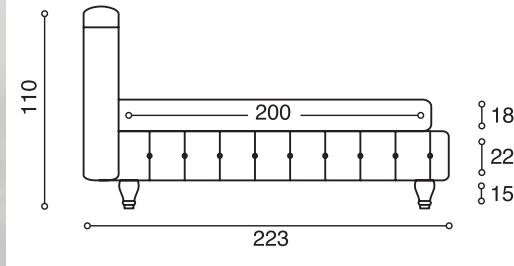

Grand Hotel h.22

- | | | |
|--|--------------|-------------|
| 1 Letto Grand Hotel matrimoniale 160x200 h.22 capitonné piedi PIE50W | art. 832/001 | Cat. E |
| 1 Completo lenzuola matrimoniale da 160 cm | art. 786/034 | Cat. Raso |
| 1 Copriletto liscio matrimoniale da 160 cm | art. 900/004 | Cat. Must |
| 1 Quilt matrimoniale da 160 cm trapuntato 5x5 | art. 969/033 | Cat. Must |
| 1 Cuscino Tondo Super | art. 969/051 | Cat. Must |
| 1 Cuscino 50x50 cm mod. Q | art. 900/004 | Cat. Must |
| 1 Cuscino 50x30 cm mod. B con bottoni | art. 900/004 | Cat. Must |
| bordo e bottoni | art. 969/055 | Cat. Must |
| 1 Cuscini 70x40 cm mod. B | art. B59/003 | Cat. E Plus |
| bordo rivestito e retro | art. 969/055 | Cat. Must |
| 1 Cuscino 50x50 cm mod. B | art. 969/055 | Cat. Must |

Grand Hotel h.22

- | | | |
|---|--------------|-------------|
| 1 Double bed Grand Hotel 160x200 h.22 capitonné feet PIE50W | art. 832/001 | Cat. E |
| 1 Double bed sheet + pillowcase set 160 cm | art. 786/034 | Cat. Raso |
| 1 Plain double bedspread 160 cm | art. 900/004 | Cat. Must |
| 1 Double quilt 5x5 160 cm | art. 969/033 | Cat. Must |
| 1 Round cushion Super | art. 969/051 | Cat. Must |
| 1 Cushion 50x50 cm mod. Q | art. 900/004 | Cat. Must |
| 1 Cushion 50x30 cm mod. B with buttons | art. 900/004 | Cat. Must |
| edge and buttons | art. 969/055 | Cat. Must |
| 2 Cushions 70x40 cm mod. B | art. B59/003 | Cat. E Plus |
| with double-pleat edge and back | art. 969/055 | Cat. Must |
| 1 Cushion 50x50 cm mod. B | art. 969/055 | Cat. Must |

Grand Hotel h.22

- | | | |
|---|--------------|-------------|
| 1 Doppelbett Grand Hotel 160x200 h.22 capitonné FüÙe PIE50W | art. 832/001 | Cat. E |
| 1 BettwäÙche-Garnitur für Doppelbett 160 cm | art. 786/034 | Cat. Raso |
| 1 Glatte Tagesdecke für Doppelbett 160 cm | art. 900/004 | Cat. Must |
| 1 Gestepppter Quilt 5x5 für Doppelbett 160 cm | art. 969/033 | Cat. Must |
| 1 Rundes Kissen Super | art. 969/051 | Cat. Must |
| 1 Kissen 50x50 cm mod. Q | art. 900/004 | Cat. Must |
| 1 Kissen 50x30 cm mod. B | art. 900/004 | Cat. Must |
| 1 Kissen 50x30 cm mod. B mit Knöpfen | art. 900/004 | Cat. Must |
| Rand und Knöpfen | art. 969/055 | Cat. Must |
| 2 Kissen 70x40 cm mod. B | art. B59/003 | Cat. E Plus |
| mit bezogenem Rand und Rückseite | art. 969/055 | Cat. Must |
| 1 Kissen 50x50 cm mod. B | art. 969/055 | Cat. Must |

Grand Hotel h.22

- | | | |
|---|--------------|-------------|
| 1 Lit Grand Hotel deux-places 160x200 h.22 capitonné pieds PIE50W | art. 832/001 | Cat. E |
| 1 Parure drap deux-places de 160 cm | art. 786/034 | Cat. Raso |
| 1 Couvre-lit lisse deux-places de 160 cm | art. 900/004 | Cat. Must |
| 1 Quilt deux-places de 160 cm surpiqué 5x5 | art. 969/033 | Cat. Must |
| 1 Oreiller Rond Super | art. 969/051 | Cat. Must |
| 1 Oreiller 50x50 cm mod. Q | art. 900/004 | Cat. Must |
| 1 Oreiller 50x30 cm mod. B | art. 900/004 | Cat. Must |
| 1 Oreiller 50x30 cm mod. B avec boutons | art. 900/004 | Cat. Must |
| bord et boutons | art. 969/055 | Cat. Must |
| 2 Oreillers 70x40 cm mod. B | art. B59/003 | Cat. E Plus |
| bord revêtu et arrière | art. 969/055 | Cat. Must |
| 1 Oreiller 50x50 cm mod. B | art. 969/055 | Cat. Must |



Dorian h.28

Pag 39

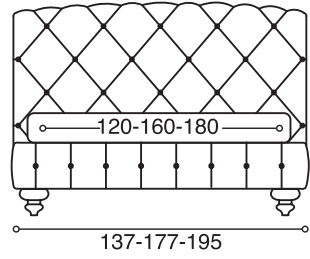
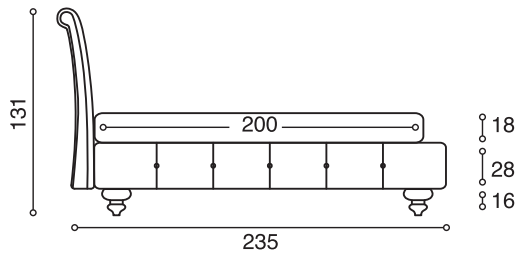

Dorian h.28

- 1 Letto Dorian matrimoniale 160x200 h.28 capitonné piede PIE64V art. 831 / 190 Cat. E Plus
- 2 Rollò con cerniera e bordo rivestito da 80 cm art. 969/001 Cat. Must
- 1 Completo lenzuola matrimoniale da 160 cm art. 990/012 Cat. Raso
- 1 Trapunta matrimoniale da 160 cm art. 843/001 Cat. Must
- 1 Trapuntatura baguette con angoli stondati art. 969/052 Cat. Must
- 1 Piumotto 160x140 cm art. 905/017 Cat. E
- 1 Plaid pelliccia Lapin 120x180 cm art. 740/008 Cat. D
- 1 Cuscino 50x50 cm mod. B con bottone art. 969/026 Cat. Must
- 1 Cuscino 50x50 cm mod. B art. 842/001 Cat. E Plus
- 1 Cuscino 50x30 cm mod. B art. 853/001 Cat. Must
- 1 Cuscino 60x60 cm mod. B art. 969/033 Cat. Must
- 1 Cuscino 50x30 cm mod. B art. 969/001 Cat. Must

Dorian h.28

- 1 Double bed Dorian 160x200 h.28 capitonné foot PIE64V art. 831 / 190 Cat. E Plus
- 2 Roll cushions with zipper and doublepleat edge da 80 cm art. 969/001 Cat. Must
- 1 Double bed sheet + pillowcase set 160 cm art. 990/012 Cat. Raso
- 1 Double-bed quilt 160 cm baguette quilting with rounded corners art. 843/001 Cat. Must
- 1 Duvet 160x140 cm art. 969/052 Cat. Must
- 1 Blanket in Lapin fur 120x180 cm art. 905/017 Cat. E
- 1 Cushion 50x50 cm mod. B con button art. 740/008 Cat. D
- 1 Cushion 50x50 cm mod. B art. 969/026 Cat. Must
- 1 Cushion 50x30 cm mod. B art. 842/001 Cat. E Plus
- 1 Cushion 50x30 cm mod. B art. 853/001 Cat. Must
- 1 Cushion 60x60 cm mod. B art. 969/033 Cat. Must
- 1 Cushion 50x30 cm mod. B art. 969/001 Cat. Must

Dorian h.28

- 1 Doppelbett Dorian 160x200 h.28 capitonné Fuß PIE64V art. 831 / 190 Cat. E Plus
- 2 Nackenrollen mit Reißverschluss und mit bezogenem Rand 80 cm art. 969/001 Cat. Must
- 1 Bettwäsche-Garnitur für Doppelbett 160 cm art. 990/012 Cat. Raso
- 1 Steppdecke für Doppelbett 160 cm Doppelnahtsteppung mit abgerundeten Ecken art. 843/001 Cat. Must
- 1 Daunendecke 160x140 cm art. 969/052 Cat. Must
- 1 Plaid aus Kaninfell 120x180 cm art. 905/017 Cat. E
- 1 Kissen 50x50 cm mod. B mit Knopf art. 740/008 Cat. D
- 1 Kissen 50x50 cm mod. B art. 969/026 Cat. Must
- 1 Kissen 50x30 cm mod. B art. 842/001 Cat. E Plus
- 1 Kissen 50x30 cm mod. B art. 853/001 Cat. Must
- 1 Kissen 60x60 cm mod. B art. 969/033 Cat. Must
- 1 Kissen 50x30 cm mod. B art. 969/001 Cat. Must

Dorian h.28

- 1 Lit Dorian deux-places 160x200 h.28 capitonné pied PIE64V art. 831 / 190 Cat. E Plus
- 2 Traversin avec fermeture éclair et bord revêtu de 80 cm art. 969/001 Cat. Must
- 1 Parure draps deux-places de 160 cm art. 990/012 Cat. Raso
- 1 Courtrepointe deux-places de 160 cm art. 843/001 Cat. Must
- 1 Couette 160x140 cm art. 969/052 Cat. Must
- 1 Plaid peau Lapin 120x180 cm art. 905/017 Cat. E
- 1 Oreiller 50x50 cm mod. B avec bouton art. 740/008 Cat. D
- 1 Oreiller 50x50 cm mod. B art. 969/026 Cat. Must
- 1 Oreiller 50x30 cm mod. B art. 842/001 Cat. E Plus
- 1 Oreiller 50x30 cm mod. B art. 853/001 Cat. Must
- 1 Oreiller 60x60 cm mod. B art. 969/033 Cat. Must
- 1 Oreiller 50x30 cm mod. B art. 969/001 Cat. Must



Dorian h.28

Pag 43

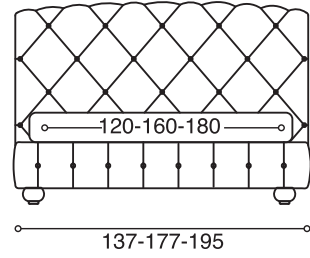
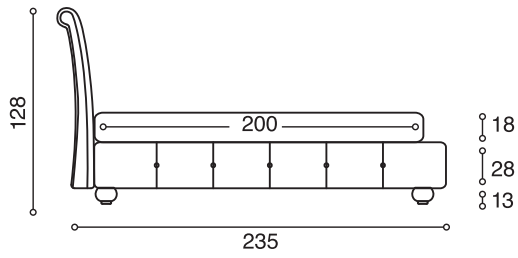

Dorian h.28

- 1 Letto Dorian matrimoniale 160x200 h.28 capitonné piede PIE48V art. 831 / 066 Cat. E Plus
- 1 Completo copripiumino da 160 cm art. 786/010 Cat. Raso
- 2 Rollò con cerniera da 80 cm art. 831 / 066 Cat. E Plus
- 1 Plaid pelliccia Lapin 120x180 cm art. 905/041 Cat. E
- 1 Plaid pelliccia Lapin 120x180 cm art. 905/016 Cat. E
- 1 Plaid pelliccia Lapin 120x180 cm art. 905/020 Cat. E
- 1 Cuscino 50x30 cm mod. B art. 969/031 Cat. Must
- 1 Cuscino 50x50 cm mod. B art. 969/010 Cat. Must
- 1 Cuscino 45x45 cm mod. B art. 843/006 Cat. Must
- 1 Cuscino 45x45 cm mod. B art. 843/005 Cat. Must
- 1 Cuscino 45x45 cm mod. B art. 843/006 Cat. Must
- 1 Cuscino 60x60 cm mod. B art. 843/005 Cat. Must
- 1 Cuscino 60x60 cm mod. B art. 857/002 Cat. E Plus
- 1 Cuscino 50x30 cm mod. B art. 831 / 066 Cat. E Plus
- 1 Poltrona Kondi aperta art. 969/031 Cat. Must

Dorian h.28

- 1 Double bed Dorian 160x200 h.28 capitonné foot PIE48V art. 831 / 066 Cat. E Plus
- 1 Duvet cover + 2 pillowcases 160 cm art. 786/010 Cat. Raso
- 2 Roll cushions with button and doublepleat edge 80 cm art. 831 / 066 Cat. E Plus
- 1 Blanket in Lapin fur 120x180 cm art. 905/041 Cat. E
- 1 Blanket in Lapin fur 120x180 cm art. 905/016 Cat. E
- 1 Blanket in Lapin fur 120x180 cm art. 905/020 Cat. E
- 1 Cushion 50x30 cm mod. B art. 969/031 Cat. Must
- 1 Cushion 50x50 cm mod. B art. 969/010 Cat. Must
- 1 Cushion 45x45 cm mod. B art. 843/006 Cat. Must
- 1 Cushion 45x45 cm mod. B with double-pleat edge art. 843/005 Cat. Must
- 1 Cushion 45x45 cm mod. B with double-pleat edge art. 843/006 Cat. Must
- 1 Cushion 60x60 cm mod. B art. 843/005 Cat. Must
- 1 Cushion 60x60 cm mod. B with double-pleat edge art. 857/002 Cat. E Plus
- 1 Armchair Kondi open art. 831 / 066 Cat. E Plus
- 1 Armchair Kondi art. 969/031 Cat. Must

Dorian h.28

- 1 Doppelbett Dorian 160x200 h.28 capitonné Fuß PIE48V art. 831 / 066 Cat. E Plus
- 1 Garnitur mit Federbettbezügen 160 cm art. 786/010 Cat. Raso
- 2 Nackenrollen mit Reißverschluss 80 cm art. 831 / 066 Cat. E Plus
- 1 Plaid aus Kaninfell 120x180 cm art. 905/041 Cat. E
- 1 Plaid aus Kaninfell 120x180 cm art. 905/016 Cat. E
- 1 Plaid aus Kaninfell 120x180 cm art. 905/020 Cat. E
- 1 Kissen 50x30 cm mod. B art. 969/031 Cat. Must
- 1 Kissen 50x50 cm mod. B art. 969/010 Cat. Must
- 1 Kissen 45x45 cm mod. B art. 843/006 Cat. Must
- 1 Kissen 45x45 cm mod. B mit bezogenem Rand art. 843/005 Cat. Must
- 1 Kissen 45x45 cm mod. B mit bezogenem Rand art. 843/006 Cat. Must
- 1 Kissen 60x60 cm mod. B art. 843/005 Cat. Must
- 1 Kissen 60x60 cm mod. B mit bezogenem Rand art. 857/002 Cat. E Plus
- 1 Offener sessel Kondi art. 831 / 066 Cat. E Plus

Dorian h.28

- 1 Lit Dorian deux-places 160x200 h.28 capitonné Pied PIE48V art. 831 / 066 Cat. E Plus
- 1 Parure housse de couette de 160 cm art. 786/010 Cat. Raso
- 2 Traversin avec fermeture éclair de 80 cm art. 831 / 066 Cat. E Plus
- 1 Plaid peau Lapin 120x180 cm art. 905/041 Cat. E
- 1 Plaid peau Lapin 120x180 cm art. 905/016 Cat. E
- 1 Plaid peau Lapin 120x180 cm art. 905/020 Cat. E
- 1 Oreiller 50x30 cm mod. B art. 969/031 Cat. Must
- 1 Oreiller 50x50 cm mod. B art. 969/010 Cat. Must
- 1 Oreiller 45x45 cm mod. B art. 843/006 Cat. Must
- 1 Oreiller 45x45 cm mod. B art. 843/005 Cat. Must
- 1 Oreiller 45x45 cm mod. B art. 843/006 Cat. Must
- 1 Oreiller 60x60 cm mod. B art. 857/002 Cat. E Plus
- 1 Oreiller 50x30 cm mod. B art. 831 / 066 Cat. E Plus
- 1 Fauteuil Kondi ouvert art. 969/031 Cat. Must



Grace h.28

Pag 47

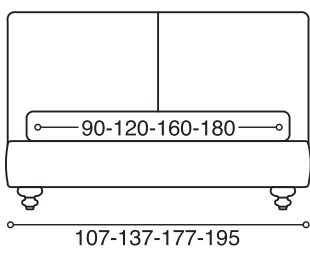
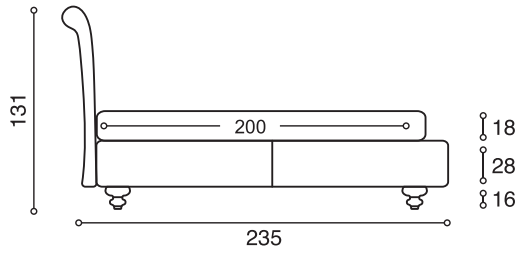

Grace h.28

- 1 Letto Grace matrimoniale 160x200 h.28 piede PIE64V art. 850/005 Cat. E Plus
- 1 Completo copripiumino matrimoniale da 160 cm art. 855/002 Cat. B
- 2 Rollo' con bottone e bordo rivestito da 80 cm art. 969/053 Cat. Must
- 1 Quilt trapuntato 5x5 matrimoniale da 160 cm art. 969/027 Cat. Must
- 1 Plaid pelliccia Lapin 120x180 cm art. 905/021 Cat. E
- 1 Cuscino 70x40 cm mod. B art. 969/053 Cat. Must
- 1 Cuscino 50x50 cm mod. B art. 969/027 Cat. Must
- 1 Cuscino 50x50 cm mod. B art. 969/027 Cat. Must
- 1 Cuscino 70x40 cm mod. B con bottoni art. 969/051 Cat. Must
- 1 Cuscino 50x30 cm mod. B art. 969/053 Cat. Must
- 1 Cuscino 50x30 cm mod. B con bottoni art. 969/027 Cat. Must
- 1 Cuscino 60x60 cm mod. B art. 969/053 Cat. Must
- 1 Cuscino 60x60 cm mod. B art. 969/054 Cat. Must
- 1 Cuscino 50x50 cm mod. B art. 969/054 Cat. Must

Grace h.28

- 1 Double bed Grace 160x200 h.28 foot PIE64V art. 850/005 Cat. E Plus
- 1 Duvet cover + 2 pillowcases 160 cm art. 855/002 Cat. B
- 2 Roll cushions with button and doublepleat edge 80 cm art. 969/053 Cat. Must
- 1 Double quilt 5x5 160 cm art. 969/027 Cat. Must
- 1 Blanket in Lapin fur 120x180 cm art. 905/021 Cat. E
- 1 Cushion 70x40 cm mod. B art. 969/053 Cat. Must
- 1 Cushion 50x50 cm mod. B art. 969/027 Cat. Must
- 1 Cushion 50x50 cm mod. B art. 969/027 Cat. Must
- 1 Cushion 70x40 cm mod. B with buttons art. 969/051 Cat. Must
- 1 Cushion 50x30 cm mod. B art. 969/053 Cat. Cat.
- 1 Cushion 50x30 cm mod. B with buttons art. 969/027 Cat. Must
- 1 Cushion 60x60 cm mod. B art. 969/053 Cat. Cat.
- 1 Cushion 60x60 cm mod. B art. 969/054 Cat. Must
- 1 Cushion 50x50 cm mod. B art. 969/054 Cat. Must

Grace h.28

- 1 Doppelbett Grace 160x200 h.28 Fuß PIE64V art. 850/005 Cat. E Plus
- 1 Garnitur mit Federbettbezügen für Doppelbett 160 cm art. 855/002 Cat. B
- 2 Nackenrollen mit Knopf und bezogenem Rand 80 cm art. 969/053 Cat. Must
- 1 Gesteppter Quilt 5x5 für Doppelbett 160 cm art. 969/027 Cat. Must
- 1 Plaid aus Kaninfell 120x180 cm art. 905/021 Cat. E
- 1 Kissen 70x40 cm mod. B art. 969/053 Cat. Must
- 1 Kissen 50x50 cm mod. B mit bezogenem Rand art. 969/027 Cat. Must
- 1 Kissen 50x50 cm mod. B mit bezogenem Rand art. 969/051 Cat. Must
- 1 Kissen 70x40 cm mod. B mit Knöpfen art. 969/051 Cat. Must
- 1 Kissen 50x30 cm mod. B mit Knöpfen art. 969/053 Cat. Must
- 1 Kissen 50x30 cm mod. B mit Knöpfen art. 969/027 Cat. Must
- 1 Kissen 60x60 cm mod. B art. 969/053 Cat. Must
- 1 Kissen 50x50 cm mod. B art. 969/054 Cat. Must

Grace h.28

- 1 Lit Grace deux-places 160x200 h.28 Pied PIE64V art. 850/005 Cat. E Plus
- 1 Parure housse de couette deux-places de 160 cm art. 855/002 Cat. B
- 2 Traversin avec bouton et bord revêtu de 80 cm art. 969/053 Cat. Must
- 1 Quilt surpiqué 5x5 deux-places de 160 cm art. 969/027 Cat. Must
- 1 Plaid peau Lapin 120x180 cm art. 905/021 Cat. E
- 1 Oreiller 70x40 cm mod. B art. 969/053 Cat. Must
- 1 Oreiller 50x50 cm mod. B art. 969/027 Cat. Must
- 1 Oreiller 50x50 cm mod. B art. 969/051 Cat. Must
- 1 Oreiller 70x40 cm mod. B avec boutons art. 969/051 Cat. Must
- 1 Oreiller 50x30 cm mod. B avec boutons art. 969/053 Cat. Must
- 1 Oreiller 50x30 cm mod. B avec boutons art. 969/027 Cat. Must
- 1 Oreiller 60x60 cm mod. B art. 969/053 Cat. Must
- 1 Oreiller 50x50 cm mod. B art. 969/054 Cat. Must



Grace Barrè h.28

Pag 51

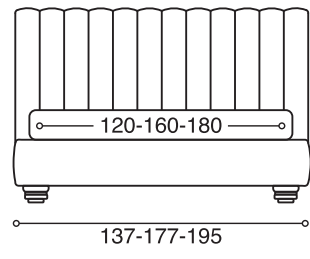
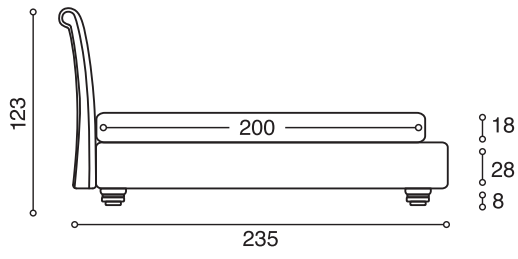

Grace Barrè h.28

- 1 Letto Grace Barre' matrimoniale 160x200 h.28 piede PIE28N art. 820/010 Cat. Must
- 1 Completo lenzuola matrimoniale da 160 cm art. 990/020 Cat. Raso
- 1 Quilt trapuntato 30x30 matrimoniale da 160 cm con angoli stondati art. 849/004 Cat. Must
- 2 Coprifedera con bordo rivestito art. 969/033 Cat. Must
- 1 Piumotto 160x140 cm art. 969/051 Cat. Must
- 1 Plaid pelliccia Lapin 120x180 cm art. 905/020 Cat. E
- 1 Cuscino 60x60 cm mod. B art. 847/004 Cat. Must
- 1 Cuscino 70x40 cm mod. B art. 849/004 Cat. Must
- 1 Cuscino 60x60 cm mod. B art. 969/051 Cat. Must
- 1 Cuscino 50x50 cm mod. B art. 969/033 Cat. Must
- 1 Cuscino 50x30 cm mod. B art. 900/005 Cat. Must
- 1 Cuscino 50x30 cm mod. B art. 969/003 Cat. Must

Grace Barrè h.28

- 1 Double bed Grace Barre' 160x200 h.28 foot PIE28N art. 820/010 Cat. Must
- 1 Double bed sheet + pillowcase set 160 cm art. 990/020 Cat. Raso
- 1 Double quilt 30x30 160 cm with rounded corners art. 849/004 Cat. Must
- 2 Pillow covers with double-pleat edge art. 969/033 Cat. Must
- 1 Duvet 160x140 cm art. 969/051 Cat. Must
- 1 Blanket in Lapin fur 120x180 cm art. 905/020 Cat. E
- 1 Cushion 60x60 cm mod. B art. 847/004 Cat. Must
- 1 Cushion 70x40 cm mod. B art. 849/004 Cat. Must
- 1 Cushion 60x60 cm mod. B art. 969/051 Cat. Must
- 1 Cushion 50x50 cm mod. B art. 969/033 Cat. Must
- 1 Cushion 50x30 cm mod. B art. 900/005 Cat. Must
- 1 Cushion 50x30 cm mod. B with double-pleat edge art. 969/003 Cat. Must

Grace Barrè h.28

- 1 Doppelbett Grace Barre' 160x200 h.28 Fuß PIE28N art. 820/010 Cat. Must
- 1 Bettwäsche-Garnitur für Doppelbett 160 cm art. 990/020 Cat. Raso
- 1 Gesteppter Quilt 30x30 für Doppelbett 160 cm art. 849/004 Cat. Must
- 2 Kissenbezüge mit bezogenem Rand art. 969/033 Cat. Must
- 1 Daunendecke 160x140 cm art. 969/051 Cat. Must
- 1 Plaid aus Kaninfell 120x180 cm art. 905/020 Cat. E
- 1 Kissen 60x60 cm mod. B art. 847/004 Cat. Must
- 1 Kissen 70x40 cm mod. B art. 849/004 Cat. Must
- 1 Kissen 60x60 cm mod. B art. 969/051 Cat. Must
- 1 Kissen 50x50 cm mod. B art. 969/033 Cat. Must
- 1 Kissen 50x30 cm mod. B art. 900/005 Cat. Must
- 1 Kissen 50x30 cm mod. B mit bezogenem Rand art. 969/003 Cat. Must

Grace Barrè h.28

- 1 Lit Grace Barre' deux-places 160x200 h.28 pied PIE28N art. 820/010 Cat. Must
- 1 Parure draps deux-places de 160 cm art. 990/020 Cat. Raso
- 1 Quilt surpiqué 30x30 deux-places de 160 cm avec angles arrondis art. 849/004 Cat. Must
- 2 Taie d'oreiller avec bord revêtu art. 969/033 Cat. Must
- 1 Couette 160x140 cm art. 969/051 Cat. Must
- 1 Plaid peau Lapin 120x180 cm art. 905/020 Cat. E
- 1 Oreiller 60x60 cm mod. B art. 847/004 Cat. Must
- 1 Oreiller 70x40 cm mod. B art. 849/004 Cat. Must
- 1 Oreiller 60x60 cm mod. B art. 969/051 Cat. Must
- 1 Oreiller 50x50 cm mod. B art. 969/033 Cat. Must
- 1 Oreiller 50x30 cm mod. B art. 900/005 Cat. Must
- 1 Oreiller 50x30 cm mod. B art. 969/003 Cat. Must



Grace Barrè h.28

Pag 55

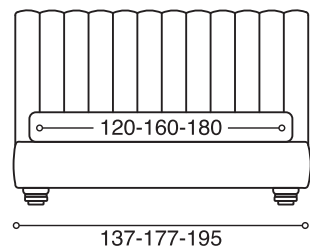
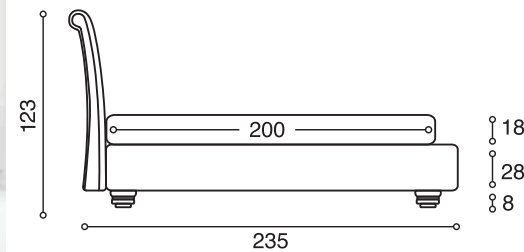

Grace Barrè con bordo rivestito h.28

1 Letto Grace Barrè con bordo rivestito matrimoniale 160x200 h. 28 box piede PIE28T	art. 969/054	Cat. Must
1 Completo lenzuola matrimoniale da 160 cm	art. 990/020	Cat. Raso
1 Quilt trapuntato 30x30 matrimoniale da 160 cm con angoli stondati	art. 847/004	Cat. Must
1 Piumotto 160x140 cm	art. 969/051	Cat. Must
1 Plaid pelliccia Lapin 120x180 cm	art. 905/020	Cat. E
1 Cuscino 70x40 cm mod. B bordo rivestito	art. 847/004	Cat. Must
1 Cuscino 70x40 cm mod. B	art. 969/054	Cat. Must
1 Cuscino 70x40 cm mod. B	art. 969/054	Cat. Must
1 Cuscino 50x30 mod. B	art. 843/007	Cat. Must
1 Cuscino 50x30 mod. B	art. 969/033	Cat. Must
1 Cuscino 50x30 mod. B	art. 900/005	Cat. Must
1 Cuscino 50x30 mod. B	art. 969/003	Cat. Must
1 Cuscino 50x30 mod. T	art. 849/004	Cat. Must
1 Pouf rotondo Ø 60 cm	art. 969/051	Cat. Must
1 Panchetta Carmen	art. 969/033	Cat. Must
1 Panchetta Carmen	art. 969/028	Cat. Must

Grace Barrè with double-pleat edge h.28

1 Double bed Grace Barrè with double-pleat edge 160x200 h. 28 box footPIE28T	art. 969/054	Cat. Must
1 Double bed sheet + pillowcase set 160 cm	art. 990/020	Cat. Raso
1 Doble quilt 30x30 160 cm with rounded corners	art. 847/004	Cat. Must
1 Duvet 160x140 cm	art. 969/051	Cat. Must
1 Blanket in Lapin fur 120x180 cm	art. 905/020	Cat. E
1 Cushion 70x40 cm mod. B	art. 847/004	Cat. Must
1 Cushion 70x40 cm mod. B	art. 969/054	Cat. Must
1 Cushion 70x40 cm mod. B	art. 969/054	Cat. Must
1 Cushion 50x30 mod. B	art. 843/007	Cat. Must
1 Cushion 50x30 mod. B	art. 969/033	Cat. Must
1 Cushion 50x30 mod. B	art. 900/005	Cat. Must
1 Cushion 50x30 mod. B	art. 969/003	Cat. Must
1 Cushion 50x30 mod. T	art. 849/004	Cat. Must
1 Round pouf Ø 60 cm	art. 969/051	Cat. Must
1 Bench Carmen	art. 969/033	Cat. Must
1 Bench Carmen	art. 969/028	Cat. Must

Grace Barrè mit bezogenem Rand h.28

1 Doppelbett Grace Barrè mit bezogenem Rand 160x200 h. 28 box Fuß PIE28T	art. 969/054	Cat. Must
1 Bettwäsche-Garnitur für Doppelbett 160 cm	art. 990/020	Cat. Raso
1 Gesteppter Quilt 30x30 für Doppelbett 160 cm mit abgerundeten Ecken	art. 847/004	Cat. Must
1 Daunendecke 160x140 cm	art. 969/051	Cat. Must
1 Plaid aus Kaninfell 120x180 cm	art. 905/020	Cat. E
1 Kissen 70x40 cm mod. B	art. 847/004	Cat. Must
1 Kissen 70x40 cm mod. B	art. 969/054	Cat. Must
1 Kissen 70x40 cm mod. B	art. 969/054	Cat. Must
1 Kissen 50x30 mod. B	art. 843/007	Cat. Must
1 Kissen 50x30 mod. B	art. 969/033	Cat. Must
1 Kissen 50x30 mod. B	art. 900/005	Cat. Must
1 Kissen 50x30 mod. B	art. 969/003	Cat. Must
1 Kissen 50x30 mod. T	art. 849/004	Cat. Must
1 Runde Pouf Ø 60 cm	art. 969/051	Cat. Must
1 Sitzbank Carmen	art. 969/033	Cat. Must
1 Sitzbank Carmen	art. 969/028	Cat. Must

Grace Barrè avec bord revêtu h.28

1 Lit Grace Barrè avec bord revêtu deux-places 160x200 h. 28 box Pied PIE28T	art. 969/054	Cat. Must
1 Parure drap deux-places de 160 cm	art. 990/020	Cat. Raso
1 Quilt surpiqué 30x30 deux-places de 160 cm avec angles arrondis	art. 847/004	Cat. Must
1 Couette 160x140 cm	art. 969/051	Cat. Must
1 Plaid peau Lapin 120x180 cm	art. 905/020	Cat. E
1 Oreiller 70x40 cm mod. B	art. 847/004	Cat. Must
1 Oreiller 70x40 cm mod. B	art. 969/054	Cat. Must
1 Oreiller 70x40 cm mod. B	art. 969/054	Cat. Must
1 Oreiller 50x30 mod. B	art. 843/007	Cat. Must
1 Oreiller 50x30 mod. B	art. 969/033	Cat. Must
1 Oreiller 50x30 mod. B	art. 900/005	Cat. Must
1 Oreiller 50x30 mod. B	art. 969/003	Cat. Must
1 Oreiller 50x30 mod. T	art. 849/004	Cat. Must
1 Pouf rond Ø 60 cm	art. 969/051	Cat. Must
1 Banquette Carmen	art. 969/033	Cat. Must
1 Banquette Carmen	art. 969/028	Cat. Must



Max Capitonè Classic h.28 box

Pag 61

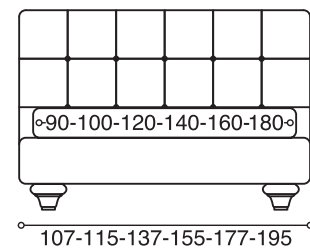
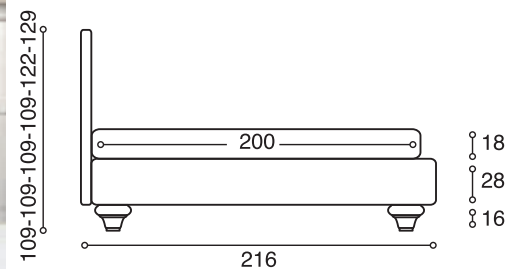

Max Capitonè Classic basso h.28 box

1 Letto Max Capitonè' Classic basso matrimoniale 160x200 h.28 box piede PIE51W	art. 832/001	Cat. E
2 Rollò con cerniera e bordo rivestito da 80 cm	art. 969/001	Cat. D
1 Completo lenzuola matrimoniale da 160 cm	art. 786/010	Cat. Raso
1 Copriletto liscio matrimoniale da 160 cm	art. A85/001	Cat. Giudecca
1 Quilt trapuntato 15x15 matrimoniale da 160 cm	art. B54/003	Cat. B
1 Plaid pelliccia Lapin 120x180 cm	art. 905/019	Cat. E
2 Cuscini 60x60 cm doppiati	art. B19/001	Cat. E Plus
1 Cuscino 60x60 cm mod. B	art. 786/010	Cat. Raso
1 Cuscino 50x30 cm mod. B	art. 969/001	Cat. Must
1 Cuscino 70x40 cm mod. B	art. 969/001	Cat. Must
1 Cuscino 70x40 cm mod. B	art. B54/003	Cat. B
1 Cuscino 70x40 cm mod. B	art. 969/001	Cat. Must
1 Poltrona Kondi chiusa	art. A07/012	Cat. Must
1 Panchetta Grace	art. 832/001	Cat. E

Max Capitonè Classic low h.28 box

1 Double bed Max Capitonè Classic Low 160x200 h.28 box piede PIE51W	art. 832/001	Cat. E
2 Roll cushions with zipper and doublepleat edge da 80 cm	art. 969/001	Cat. D
1 Double bed sheet + pillowcase set 160 cm	art. 786/010	Cat. Raso
1 Plain double bedspread 160 cm	art. A85/001	Cat. Giudecca
1 Double quilt 15x15 160 cm	art. B54/003	Cat. B
1 Blanket in Lapin fur 120x180 cm	art. 905/019	Cat. E
2 Cushions 60x60 cm double	art. B19/001	Cat. E Plus
1 Cushion 60x60 cm mod. B	art. 786/010	Cat. Raso
1 Cushion 50x30 cm mod. B	art. 969/001	Cat. Must
1 Cushion 70x40 cm mod. B	art. 969/001	Cat. Must
1 Cushion 70x40 cm mod. B	art. B54/003	Cat. B
1 Cushion 70x40 cm mod. B	art. 969/001	Cat. Must
1 Armchair Kondi closed	art. A07/012	Cat. Must
1 Bench Grace	art. 832/001	Cat. E

Max Capitonè Classic Niedrig h.28 box

1 Doppelbett Max Capitonè' Classic Niedrig 160x200 h.28 box Fuß PIE51W	art. 832/001	Cat. E
2 Nackenrollen mit Reißverschluss und bezogenem Rand 80 cm	art. 969/001	Cat. D
1 Bettwäsche-Garnitur für Doppelbett 160 cm	art. 786/010	Cat. Raso
1 Glatte Tagesdecke für Doppelbett 160 cm	art. A85/001	Cat. B
1 Gesteppter Quilt 15x15 für Doppelbett 160 cm	art. B54/003	Cat. B
1 Plaid aus Kaninfell 120x180 cm	art. 905/019	Cat. E
2 Kissen 60x60 cm doppelt	art. B19/001	Cat. E Plus
1 Kissen 60x60 cm mod. B	art. 786/010	Cat. Raso
1 Kissen 50x30 cm mod. B	art. 969/001	Cat. Must
1 Kissen 70x40 cm mod. B	art. 969/001	Cat. Must
1 Kissen 70x40 cm mod. B	art. B54/003	Cat. B
1 Kissen 70x40 cm mod. B	art. 969/001	Cat. Must
1 Sessel Kondi geschlossen	art. A07/012	Cat. Must
1 Sitzbank Grace	art. 832/001	Cat. E

Max Capitonè Classic bas h.28 box

1 Lit Max Capitonè Classic Bas deux-places 160x200 h.28 box Pied PIE51W	art. 832/001	Cat. E
2 Traversin avec fermeture éclair et bord revêtu de 80 cm	art. 969/001	Cat. D
1 Parure draps deux-places de 160 cm	art. 786/010	Cat. Raso
1 Couvre-lit lisse deux-places de 160 cm	art. A85/001	Cat. Giudecca
1 Quilt surpiqué 15x15 deux-places de 160 cm	art. B54/003	Cat. B
1 Plaid peau Lapin 120x180 cm	art. 905/019	Cat. E
2 Oreillers 60x60 cm doublés	art. B19/001	Cat. E Plus
1 Oreiller 60x60 cm mod. B	art. 786/010	Cat. Raso
1 Oreiller 50x30 cm mod. B	art. 969/001	Cat. Must
1 Oreiller 70x40 cm mod. B	art. 969/001	Cat. Must
1 Oreiller 70x40 cm mod. B	art. B54/003	Cat. B
1 Oreiller 70x40 cm mod. B	art. 969/001	Cat. Must
1 Fauteuil Kondi fermé	art. A07/012	Cat. Must
1 Banquette Grace	art. 832/001	Cat. E



Max Capitonè Soft h.28

Pag 65

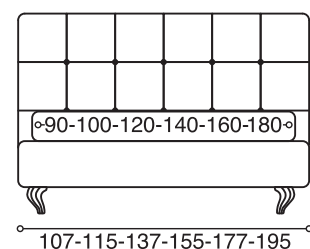
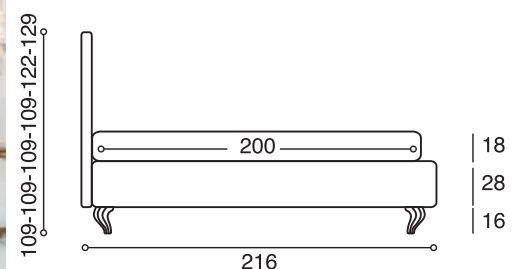

Max Capitonè Soft basso h.28

1 Letto Max Capitonè' Soft basso 180x200 h. 28 cm chiodato con bottoni Swarovsky piede PIE65S	art. 832/480	Cat. E
2 Rollò con bottoni da 90 cm	art. B43/002	Cat. Must
1 Quilt trapuntato 15x15 matrimoniale da 180 cm	art. B52/003	Cat. E
1 Piumotto 180x140 cm	art. B43/002	Cat. Must
1 Piumotto 180x140 cm	art. 969/033	Cat. Must
1 Cuscino Tondo Super con bottone	art. B43/002	Cat. Must
1 Cuscino 50x30 cm mod. T con bottoni Swarovsky	art. B48/001	Cat. Must
1 Cuscino 50x50 cm mod. T	art. 969/033	Cat. Must
1 Cuscino 50x50 cm mod. B	art. B48/001	Cat. Must
1 Cuscino 60x60 cm mod. Q	art. 969/033	Cat. Must
1 Cuscino 60x60 cm mod. T	art. B49/001	Cat. Must
1 Cuscino 50x50 cm mod. T	art. 900/002	Cat. Must
1 Cuscino 50x50 cm mod. T	art. B43/002	Cat. Must

Max Capitonè Soft low h.28

1 Double bed Max Capitonè' Soft low 180x200 h. 28 cm nailed with Swarovsky buttons foot PIE65S	art. 832/480	Cat. E
2 Roll cushions with buttons 90 cm	art. B43/002	Cat. Must
1 Double quilt 15x15 180 cm	art. B52/003	Cat. E
1 Duvet 180x140 cm	art. B43/002	Cat. Must
1 Duvet 180x140 cm	art. 969/033	Cat. Must
1 Round cushion Super with button	art. B43/002	Cat. Must
1 Cushion 50x30 cm mod. T with Swarovsky buttons	art. B48/001	Cat. Must
1 Cushion 50x50 cm mod. T	art. 969/033	Cat. Must
1 Cushion 50x50 cm mod. B	art. B48/001	Cat. Must
1 Cushion 60x60 cm mod. Q	art. 969/033	Cat. Must
1 Cushion 60x60 cm mod. T	art. B49/001	Cat. Must
1 Cushion 50x50 cm mod. T	art. 900/002	Cat. Must
1 Cushion 50x50 cm mod. T	art. B43/002	Cat. Must

Max Capitonè Soft Niedrig h.28

1 Bett Max Capitonè' Soft Niedrig 180x200 h. 28 cm genietet mit Knöpfen Swarovsky Fuß PIE65S	art. 832/480	Cat. E
2 Nackenrollen mit Knöpfen 90 cm	art. B43/002	Cat. Must
1 Gesteppter Quilt 15x15 für Doppelbett 180 cm	art. B52/003	Cat. E
1 Daunendecke 180x140 cm	art. B43/002	Cat. Must
1 Daunendecke 180x140 cm	art. 969/033	Cat. Must
1 Rundes Kissen Super mit Knopf	art. B43/002	Cat. Must
1 Kissen 50x30 cm mod. T mit Knöpfen Swarovsky	art. B48/001	Cat. Must
1 Kissen 50x50 cm mod. T	art. 969/033	Cat. Must
1 Kissen 50x50 cm mod. B	art. B48/001	Cat. Must
1 Kissen 60x60 cm mod. Q	art. 969/033	Cat. Must
1 Kissen 60x60 cm mod. T	art. B49/001	Cat. Must
1 Kissen 50x50 cm mod. T	art. 900/002	Cat. Must
1 Kissen 50x50 cm mod. T	art. B43/002	Cat. Must

Max Capitonè Soft bas h.28

1 Lit Max Capitonè Soft bas 180x200 h. 28 cm cloué avec boutons Swarovsky pied PIE65S	art. 832/480	Cat. E
2 Traversin avec boutons de 90 cm	art. B43/002	Cat. Must
1 Couvre-lit matelassé 15x15 deux-places de 180 cm	art. B52/003	Cat. E
1 Couette 180x140 cm	art. B43/002	Cat. Must
1 Couette 180x140 cm	art. 969/033	Cat. Must
1 Oreiller rond Super avec bouton	art. B43/002	Cat. Must
1 Oreiller 50x30 cm mod. T avec boutons Swarovsky	art. B48/001	Cat. Must
1 Oreiller 50x50 cm mod. T	art. 969/033	Cat. Must
1 Oreiller 50x50 cm mod. B	art. B48/001	Cat. Must
1 Oreiller 60x60 cm mod. Q	art. 969/033	Cat. Must
1 Oreiller 60x60 cm mod. T	art. B49/001	Cat. Must
1 Oreiller 50x50 cm mod. T	art. 900/002	Cat. Must
1 Oreiller 50x50 cm mod. T	art. B43/002	Cat. Must



Matisse h.28

Pag 71

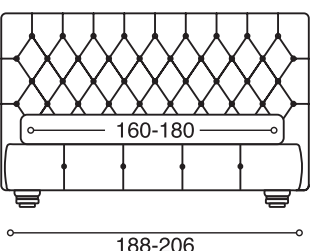
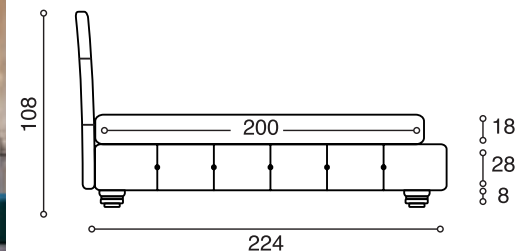

Matisse h.28

1 Letto Matisse matrimoniale 160x200 h.28 capitonè piede PIE28T	art. B20/002	Cat. Must
2 Rollò con cerniera e bordo rivestito da 80 cm	art. B43/007	Cat. Must
1 Copriletto liscio matrimoniale da 160 cm	art. B43/007	Cat. Must
1 Piumotto 160x140 cm	art. 969/054	Cat. Must
1 Plaid pelliccia Lapin 120x180 cm	art. 905/037	Cat. E
1 Cuscino 70x40 cm mod. B con bottoni	art. 969/054	Cat. Must
1 Cuscino 70x40 cm mod. B	art. B43/007	Cat. Must
1 Cuscino 50x50 cm mod. B	art. B48/001	Cat. Must
1 Cuscino 50x30 cm mod. B	art. 969/033	Cat. E
1 Cuscino 50x30 cm mod. B	art. B57/001	Cat. E Plus
1 Cuscino 50x30 cm mod. B	art. 969/004	Cat. Must
1 Pouf Soft rotondo Ø 85 cm	art. 969/062	Cat. Must
1 Panchetta Louise	art. B20/010	Cat. Must

Matisse h.28

1 Double bed Matisse 160x200 h.28 capitonè foot PIE28T	art. B20/002	Cat. Must
2 Roll cushions with zipper and double-pleat edge 80 cm	art. B43/007	Cat. Must
1 Plain double bedspread 160 cm	art. B43/007	Cat. Must
1 Duvet 160x140 cm	art. 969/054	Cat.



Matisse h.28

Pag 77

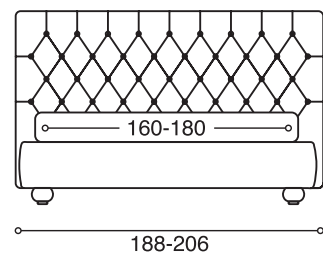
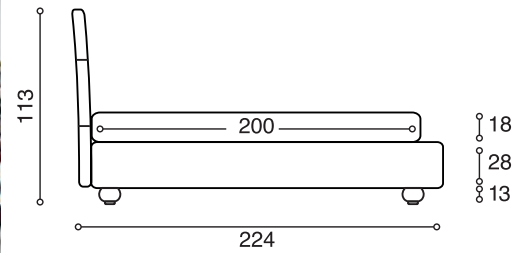

Matisse h.28

- | | | |
|---|--------------|-------------|
| 1 Letto Matisse matrimoniale 160x200 h.28 chiodato piede PIE48V | art. 831/190 | Cat. E Plus |
| 1 Trapunta 200 gr trapuntata baguette matr. da 160 cm | art. B43/001 | Cat. Must |
| 1 Piumotto 160x140 cm | art. B52/011 | Cat. E |
| 1 Plaid pelliccia Lapin 120x180 cm | art. 905/037 | Cat. E |
| 1 Cuscino 60x60 cm mod. B | art. 969/062 | Cat. Must |
| 1 Cuscino 70x40 cm mod. T con bottoni | art. 969/054 | Cat. Must |
| 1 Cuscino 45x45 cm mod. T | art. 969/008 | Cat. Must |
| 1 Cuscino 50x50 cm mod. T con bottone | art. 969/001 | Cat. Must |
| 1 Poltrona Velvet | art. 969/054 | Cat. Must |
| 1 Poltrona Velvet | art. 969/003 | Cat. Must |
| bordo rivestito | art. 969/031 | Cat. Must |

Matisse h.28

- | | | |
|--|--------------|-------------|
| 1 Double bed Matisse 160x200 h.28 nailed foot PIE48V | art. 831/190 | Cat. E Plus |
| 1 Double-bed quilt 200 gr baguette quilting 160 cm | art. B43/001 | Cat. Must |
| 1 Duvet 160x140 cm | art. B52/011 | Cat. E |
| 1 Blanket in Lapin fur 120x180 cm | art. 905/037 | Cat. E |
| 1 Cushion 60x60 cm mod. B | art. 969/062 | Cat. Must |
| 1 Cushion 70x40 cm mod. T with buttons | art. 969/054 | Cat. Must |
| 1 Cushion 45x45 cm mod. T | art. 969/008 | Cat. Must |
| 1 Cushion 50x50 cm mod. T with buttons | art. 969/001 | Cat. Must |
| 1 Armchair Velvet | art. 969/054 | Cat. Must |
| with double-pleat edge | art. 969/003 | Cat. Must |

Matisse h.28

- | | | |
|---|--------------|-------------|
| 1 Doppelbett Matisse 160x200 h.28 genietet Fuß PIE48V | art. 831/190 | Cat. E Plus |
| 1 Steppdecke für Doppelbett 200 g Doppelnahtsteppung 160 cm | art. B43/001 | Cat. Must |
| 1 Daunendecke 160x140 cm | art. B52/011 | Cat. E |
| 1 Plaid aus Kaninfell 120x180 cm | art. 905/037 | Cat. E |
| 1 Kissen 60x60 cm mod. B | art. 969/062 | Cat. Must |
| 1 Kissen 70x40 cm mod. T mit Knöpfen | art. 969/054 | Cat. Must |
| 1 Kissen 45x45 cm mod. T | art. 969/008 | Cat. Must |
| 1 Kissen 50x50 cm mod. T mit Knöpfen | art. 969/001 | Cat. Must |
| 1 Sessel Velvet | art. 969/054 | Cat. Must |
| mit bezogenem Rand | art. 969/003 | Cat. Must |

Matisse h.28

- | | | |
|--|--------------|-------------|
| 1 Lit Matisse deux-places 160x200 h.28 cloué pied PIE48V | art. 831/190 | Cat. E Plus |
| 1 Courtepointe 200 gr surpiquée baguette matr. de 160 cm | art. B43/001 | Cat. Must |
| 1 Couette 160x140 cm | art. B52/011 | Cat. E |
| 1 Plaid peau Lapin 120x180 cm | art. 905/037 | Cat. E |
| 1 Oreiller 60x60 cm mod. B | art. 969/062 | Cat. Must |
| 1 Oreiller 70x40 cm mod. T avec boutons | art. 969/054 | Cat. Must |
| 1 Oreiller 45x45 cm mod. T | art. 969/008 | Cat. Must |
| 1 Oreiller 50x50 cm mod. T avec bouton | art. 969/001 | Cat. Must |
| 1 Fauteuil Velvet | art. 969/054 | Cat. Must |
| bord revêtu | art. 969/003 | Cat. Must |



Camille Capitonè alto h.28

Pag 81

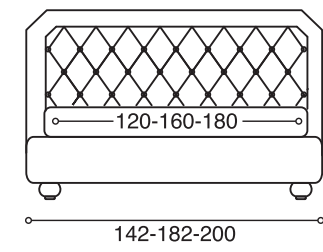
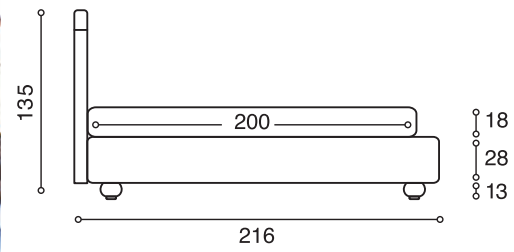

Camille Capitonè alto h.28

- | | | |
|---|--------------|-------------|
| 1 Letto Camille Capitonè Alto 180x200 h.28 piede PIE48T | art. B50/002 | Cat. E Plus |
| 2 Rollo' con bottone e bordo rivestito da 90 cm | art. 969/053 | Cat. Must |
| bordo rivestito e bottone | art. 969/027 | Cat. Must |
| 1 Quilt trapuntato 15x15 matrimoniale da 180 cm | art. B52/003 | Cat. E |
| 1 Completo copripiumino matrimoniale da 180 cm | art. 990/012 | Cat. Raso |
| 1 Piumotto 160x140 cm | art. 969/052 | Cat. Must |
| 1 Plaid pelliccia Lapin 120x180 cm | art. 905/017 | Cat. E |
| 1 Cuscino 70x40 cm mod. B | art. 969/053 | Cat. Must |
| 1 Cuscino 50x30 cm mod. B | art. 969/031 | Cat. Must |
| 1 Cuscino 50x50 cm mod. B | art. 969/033 | Cat. Must |
| 1 Cuscino 50x50 cm mod. B | art. 969/004 | Cat. Must |
| 1 Cuscino 50x50 cm mod. B con bottoni | art. 969/028 | Cat. Must |
| bordo rivestito e bottoni | art. 969/033 | Cat. Must |

Camille Capitonè high h.28

- | | | |
|---|--------------|-------------|
| 1 Double bed Camille Capitonè High 180x200 h.28 foot PIE48T | art. B50/002 | Cat. E Plus |
| 2 Roll cushions with button and double-pleat edge 90 cm | art. 969/053 | Cat. Must |
| with double-pleat edge and button | art. 969/027 | Cat. Must |
| 1 Double quilt 15x15 180 cm | art. B52/003 | Cat. E |
| 1 Duvet cover + 2 pillowcases 180 cm | art. 990/012 | Cat. Raso |
| 1 Duvet 160x140 cm | art. 969/052 | Cat. Must |
| 1 Blanket in Lapin fur 120x180 cm | art. 905/017 | Cat. E |
| 1 Cushion 70x40 cm mod. B | art. 969/053 | Cat. Must |
| 1 Cushion 50x30 cm mod. B | art. 969/031 | Cat. Must |
| 1 Cushion 50x50 cm mod. B | art. 969/033 | Cat. Must |
| 1 Cushion 50x50 cm mod. B | art. 969/004 | Cat. Must |
| 1 Cushion 50x50 cm mod. B with buttons | art. 969/028 | Cat. Must |
| with double-pleat edge and button | art. 969/033 | Cat. Must |

Camille Capitonè Hoch h.28

- | | | |
|---|--------------|-------------|
| 1 Bett Camille Capitonè Hoch 180x200 h.28 Fuß PIE48T | art. B50/002 | Cat. E Plus |
| 2 Nackenrollen mit Knopf und bezogenem Rand 90 cm | art. 969/053 | Cat. Must |
| mit bezogenem Rand und Knopf | art. 969/027 | Cat. Must |
| 1 Gesteppter Quilt 15x15 für Doppelbett 180 cm | art. B52/003 | Cat. E |
| 1 Garnitur mit Federbettbezügen für Doppelbett 180 cm | art. 990/012 | Cat. Raso |
| 1 Daunendecke 160x140 cm | art. 969/052 | Cat. Must |
| 1 Plaid aus Kaninfell 120x180 cm | art. 905/017 | Cat. E |
| 1 Kissen 70x40 cm mod. B | art. 969/053 | Cat. Must |
| 1 Kissen 50x30 cm mod. B | art. 969/031 | Cat. Must |
| 1 Kissen 50x50 cm mod. B | art. 969/033 | Cat. Must |
| 1 Kissen 50x50 cm mod. B | art. 969/004 | Cat. Must |
| 1 Kissen 50x50 cm mod. B mit Knöpfen | art. 969/028 | Cat. Must |
| mit bezogenem Rand und Knöpfen | art. 969/033 | Cat. Must |

Camille Capitonè haut h.28

- | | | |
|--|--------------|-------------|
| 1 Lit Camille Capitonè Haut 180x200 h.28 pied PIE48T | art. B50/002 | Cat. E Plus |
| 2 Traversin' avec bouton et bord revêtu de 90 cm | art. 969/053 | Cat. Must |
| bord revêtu et bouton | art. 969/027 | Cat. Must |
| 1 Quilt surpiqué 15x15 deux-places de 180 cm | art. B52/003 | Cat. E |
| 1 Parure housse de couette deux-places de 180 cm | art. 990/012 | Cat. Raso |
| 1 Couette 160x140 cm | art. 969/052 | Cat. Must |
| 1 Plaid peau Lapin 120x180 cm | art. 905/017 | Cat. E |
| 1 Oreiller 70x40 cm mod. B | art. 969/053 | Cat. Must |
| 1 Oreiller 50x30 cm mod. B | art. 969/031 | Cat. Must |
| 1 Oreiller 50x50 cm mod. B | art. 969/033 | Cat. Must |
| 1 Oreiller 50x50 cm mod. B | art. 969/004 | Cat. Must |
| 1 Oreiller 50x50 cm mod. B avec boutons | art. 969/028 | Cat. Must |
| bord revêtu et boutons | art. 969/033 | Cat. Must |



Camille con gonna

Pag 85

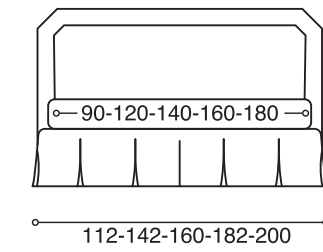
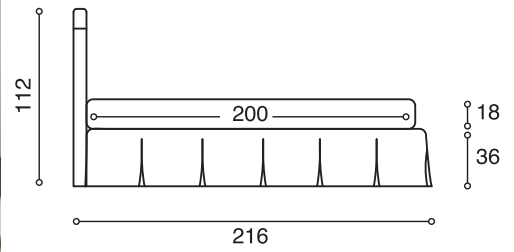

Camille con gonna

- | | | |
|---|--------------|-------------|
| 1 Letto Camille matrimoniale 160x200 c/gonna a faldoni pannello | art. A64/024 | Cat. Must |
| 1 Completo lenzuola matrimoniale da 160 cm | art. B46/003 | Cat. Must |
| 1 Quilt trapuntato baguette matrimoniale da 160 cm | art. 990/020 | Cat. Raso |
| 2 Rollo' con bottone e bordo rivestito da 80 cm | art. 969/052 | Cat. Must |
| 1 Piumotto 160x140 cm | art. 969/052 | Cat. Must |
| 1 Cuscino 60x60 cm mod. B | art. B58/001 | Cat. E Plus |
| 1 Cuscino 60x60 cm mod. B | art. B52/011 | Cat. E |
| 1 Cuscino 50x30 cm mod. B | art. B52/003 | Cat. E |
| 1 Cuscino 50x30 cm mod. B | art. 969/051 | Cat. Must |
| 1 Cuscino 50x50 cm mod. B | art. 969/050 | Cat. Must |
| 1 Cuscino 45x45 cm mod. B | art. A64/024 | Cat. Must |
| 1 Panchetta Carmen | art. 969/033 | Cat. Must |
| bordo rivestito | art. 969/028 | Cat. Must |
| 1 Pouf Soft rotondo ø 85 cm | art. A64/024 | Cat. Must |

Camille with skirt

- | | | |
|---|--------------|-------------|
| 1 Double bed Camille 160x200 w/inverted-pleat skirt panel | art. A64/024 | Cat. Must |
| 1 Double bed sheet + pillowcase set 160 cm | art. B46/003 | Cat. Must |
| 1 Double-bed quilt 160 cm baguette quilting | art. 990/020 | Cat. Raso |
| 2 Roll cushions with button and double-pleat edge 80 cm | art. 969/052 | Cat. Must |
| 1 Duvet 160x140 cm | art. 969/052 | Cat. Must |
| 1 Cushion 60x60 cm mod. B | art. B58/001 | Cat. E Plus |
| 1 Cushion 60x60 cm mod. B | art. B52/011 | Cat. E |
| 1 Cushion 50x30 cm mod. B | art. B52/003 | Cat. E |
| 1 Cushion 50x30 cm mod. B | art. 969/051 | Cat. Must |
| 1 Cushion 50x50 cm mod. B | art. 969/050 | Cat. Must |
| 1 Cushion 45x45 cm mod. B | art. A64/024 | Cat. Must |
| 1 Bench Carmen | art. 969/033 | Cat. Must |
| with double-pleat edge | art. 969/028 | Cat. Must |
| 1 Pouf Soft round ø 85 cm | art. A64/024 | Cat. Must |

Camille mit Volant

- | | | |
|--|--------------|-------------|
| 1 Doppelbett Camille 160x200 mit Faltenvolant Paneel | art. A64/024 | Cat. Must |
| 1 Bettwäsche-Garnitur für Doppelbett 160 cm | art. B46/003 | Cat. Must |
| 1 Gesteppter Quilt für Doppelbett 160 cm Doppelnaht | art. 990/020 | Cat. Raso |
| 2 Nackenrollen mit Knopf und bezogenem Rand 80 cm | art. 969/052 | Cat. Must |
| 1 Daunendecke 160x140 cm | art. 969/052 | Cat. Must |
| 1 Kissen 60x60 cm mod. B | art. B58/001 | Cat. E Plus |
| 1 Kissen 60x60 cm mod. B | art. B52/011 | Cat. E |
| 1 Kissen 50x30 cm mod. B | art. B52/003 | Cat. E |
| 1 Kissen 50x30 cm mod. B | art. 969/051 | Cat. Must |
| 1 Kissen 50x50 cm mod. B | art. 969/050 | Cat. Must |
| 1 Kissen 45x45 cm mod. B | art. A64/024 | Cat. Must |
| 1 Sitzbank Carmen | art. 969/033 | Cat. Must |
| mit bezogenem Rand | art. 969/028 | Cat. Must |
| 1 Runder Pouf Soft ø 85 cm | art. A64/024 | Cat. Must |

Camille avec couvre-sommier

- | | | |
|---|--------------|-------------|
| 1 Lit Camille deux-places 160x200 avec couvre-sommier à bords | art. A64/024 | Cat. Must |
| panneau | art. B46/003 | Cat. Must |
| 1 Parure drap deux-places de 160 cm | art. 990/020 | Cat. Raso |
| 1 Quilt surpiqué baguette deux-places de 160 cm | art. 990/020 | Cat. Raso |
| 2 Traversin avec bouton et bord revêtu de 80 cm | art. 969/052 | Cat. Must |
| 1 Couette 160x140 cm | art. 969/052 | Cat. Must |
| 1 Oreiller 60x60 cm mod. B | art. B58/001 | Cat. E Plus |
| 1 Oreiller 60x60 cm mod. B | art. B52/011 | Cat. E |
| 1 Oreiller 50x30 cm mod. B | art. B52/003 | Cat. E |
| 1 Oreiller 50x30 cm mod. B | art. 969/051 | Cat. Must |
| 1 Oreiller 50x50 cm mod. B | art. 969/050 | Cat. Must |
| 1 Oreiller 45x45 cm mod. B | art. 969/050 | Cat. Must |
| 1 Banquette Carmen | art. A64/024 | Cat. Must |
| bord revêtu | art. 969/033 | Cat. Must |
| 1 Pouf Soft rond ø de 85 cm | art. A64/024 | Cat. Must |



Giselle con gonna

Pag 93

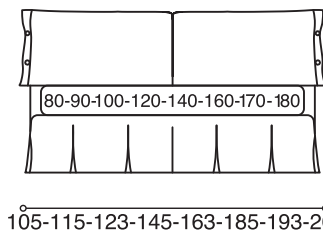
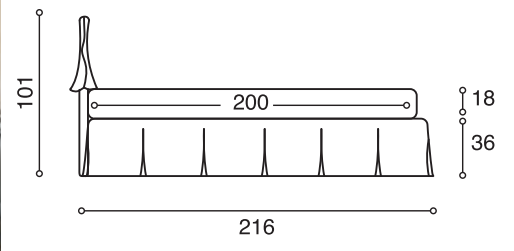

Giselle con gonna

- | | | |
|--|--------------------|---------------|
| 1 Letto Giselle matrimoniale 160x200 c/gonna a faldoni | art. A64/015 | Cat. Must |
| cuscini caprestiera doppiati | art. B19/002 | Cat. E Plus |
| 1 Quilt trapuntato 5x5 matrimoniale da 160 cm | art. 969/033 | Cat. Must |
| 1 Copriletto liscio matrimoniale da 160 cm | art. A85/004 | Cat. Giudecca |
| 1 Plaid Cashmere 170x175 cm | art. 514XOHC000002 | Cat. Giudecca |
| 1 Plaid liscio 230x120 doppiato | art. A64/015 | Cat. Must |
| 1 Cuscino 60x60 cm mod. B | art. B19/002 | Cat. E Plus |
| 1 Cuscino 60x60 cm mod. B | art. A64/015 | Cat. Must |
| 1 Cuscino 50x30 cm mod. B doppiato | art. B19/002 | Cat. E Plus |
| 1 Cuscino 50x30 cm mod. B | art. 969/033 | Cat. Must |
| 1 Cuscino 70x40 mod. Q con 3 rose rouche | art. A64/015 | Cat. Must |
| 1 Table Habille' | art. 969/033 | Cat. Must |
| 1 Poltrona Tea | art. 969/054 | Cat. Must |
| 1 Panchetta Carmen | art. 969/033 | Cat. Must |
| bordo rivestito | art. 969/028 | Cat. Must |

Giselle with skirt

- | | | |
|---|--------------------|---------------|
| 1 Double bed Giselle 160x200 w/inverted-pleat skirt | art. A64/015 | Cat. Must |
| double headboard cushions | art. B19/002 | Cat. E Plus |
| 1 Double quilt 160 cm 5x5 | art. 969/033 | Cat. Must |
| 1 Plain double bedspread 160 cm | art. A85/004 | Cat. Giudecca |
| 1 Cashmere plaid 170x175 cm | art. 514XOHC000002 | Cat. Giudecca |
| 1 Plain plaid 230x120 double | art. A64/015 | Cat. Must |
| 1 Cushion 60x60 cm mod. B | art. B19/002 | Cat. E Plus |
| 1 Cushion 60x60 cm mod. B | art. A64/015 | Cat. Must |
| 1 Cushion 50x30 cm mod. B | art. B19/002 | Cat. E Plus |
| 1 Cushion 50x30 cm mod. B | art. 969/033 | Cat. Must |
| 1 Cushion 70x40 mod. Q with 3 rouche roses | art. A64/015 | Cat. Must |
| 1 Table Habille' | art. 969/033 | Cat. Must |
| 1 Armchair Tea | art. 969/054 | Cat. Must |
| 1 Bench Carmen | art. 969/033 | Cat. Must |
| with double-pleat edge | art. 969/028 | Cat. Must |

Giselle mit Volant

- | | | |
|--|--------------------|---------------|
| 1 Doppelbett Giselle 160x200 mit Samtfalten | art. A64/015 | Cat. Must |
| Kissen für Kopfteil doppelt | art. B19/002 | Cat. E Plus |
| 1 Gesteppter Quilt 5x5 für Doppelbett 160 cm | art. 969/033 | Cat. Must |
| 1 Glatte Tagesdecke für Doppelbett 160 cm | art. A85/004 | Cat. Giudecca |
| 1 Plaid aus Cashmere 170x175 cm | art. 514XOHC000002 | Cat. Giudecca |
| 1 Glatter Plaid 230x120 doppelt | art. A64/015 | Cat. Must |
| 1 Kissen 60x60 cm mod. B | art. B19/002 | Cat. E Plus |
| 1 Kissen 60x60 cm mod. B | art. A64/015 | Cat. Must |
| 1 Kissen 50x30 cm mod. B | art. B19/002 | Cat. E Plus |
| 1 Kissen 50x30 cm mod. B | art. 969/033 | Cat. Must |
| 1 Kissen 70x40 mod. Q mit 3 Rosen rouche | art. A64/015 | Cat. Must |
| 1 Table Habille' | art. 969/054 | Cat. Must |
| 1 Sessel Tea | art. 969/033 | |



Giselle con gonna

Pag 97



Giselle con gonna

- 1 Letto Giselle matrimoniale 160x200 c./gonna a faldoni cuscini copristiera con bottoni Swarovsky art. A64/015 Cat. Must
- 2 Rollò con bottone Swarovsky da 80 cm art. A64/015 Cat. Must
- 1 Quilt matrimoniale da 160 cm trapuntato quadro art. 990/020 Cat. Raso
- 1 Copriletto liscio matrimoniale da 160 cm art. A64/015 Cat. Must
- 1 Piumotto 160x140 cm art. B52/011 Cat. E
- 1 Plaid pelliccia Lapin 120x180 cm art. 905/037 Cat. E
- 1 Cuscino 50x30 cm mod. B con bottoni Swarovsky art. A64/015 Cat. Must
- 1 Cuscino 70x40 cm mod. B con bottoni bordo rivestito e bottoni art. 969/054 Cat. Must
- 1 Cuscino 70x40 cm mod. B con bottoni bordo rivestito e bottoni art. B43/007 Cat. Must
- 1 Cuscino 50x30 cm mod. B art. 969/028 Cat. Must
- 1 Cuscino 50x30 cm mod. B art. 969/033 Cat. Must



Medea h.22

Pag 99

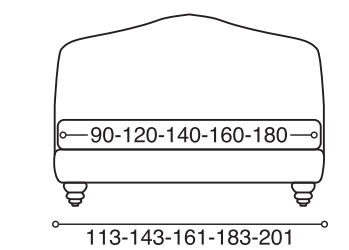
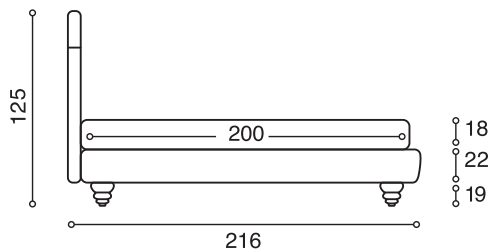

Medea h.22

- 1 Letto Medea matrimoniale 160x200 h.22 con bordo rivestito piede PIE7IT art. B53/001 Cat. Must
- 2 Rollò con cerniera e bordo rivestito da 80 cm art. 969/033 Cat. Must
- 1 Quilt matrimoniale da 160 cm trapuntato quadro 5x5 art. 969/033 Cat. Must
- 1 Quilt matrimoniale da 160 cm trapuntato baguette art. 990/020 Cat. Raso
- 1 Piumotto 160x140 cm art. 969/050 Cat. Must
- 1 Plaid pelliccia Lapin 120x180 cm art. 905/017 Cat. E
- 1 Plaid lana merinos superfine con frange 130x180 cm art. 515XFDCA000002 Cat. C
- 1 Cuscino 50x30 cm mod. B con bottoni bordo rivestito e bottoni art. A38/027 Cat. Must
- 1 Cuscino 50x30 cm mod. B art. 969/033 Cat. Must
- 1 Cuscino 50x50 cm mod. B art. 969/050 Cat. Must
- 1 Cuscino 50x50 cm mod. B art. B53/001 Cat. Must
- 1 Cuscino 50x30 cm mod. B art. 969/033 Cat. Must
- 1 Cuscino 50x30 cm mod. B art. B53/001 Cat. Must
- 1 Cuscino 70x40 cm mod. B con bottoni bordo rivestito e bottoni art. A38/027 Cat. C
- 1 Table Habille' art. 969/054 Cat. Must
- 1 Poltrona Tea art. 969/033 Cat. Must

Giselle with skirt

- 1 Double bed Giselle 160x200 w/ inverted-pleat skirt art. A64/015 Cat. Must
- 2 Roll cushions with Swarovsky buttons 80 cm art. A64/015 Cat. Must
- 1 Double-bed quilt 160 cm baguette quilting art. 990/020 Cat. Raso
- 1 Plain double bedspread 160 cm art. A64/015 Cat. Must
- 1 Duvet 160x140 cm art. B52/011 Cat. E
- 1 Blanket in Lapin fur 120x180 cm art. 905/037 Cat. E
- 1 Cushion 50x30 cm mod. B with Swarovsky buttons art. A64/015 Cat. Must
- 1 Cushion 70x40 cm mod. B with buttons art. 969/054 Cat. Must
- 1 Cushion 70x40 cm mod. B with buttons with double-pleat edge and buttons art. 969/062 Cat. Must
- 1 Cushion 70x40 cm mod. B with buttons with double-pleat edge and buttons art. B43/007 Cat. Must
- 1 Cushion 50x30 cm mod. B art. 969/028 Cat. Must
- 1 Cushion 50x30 cm mod. B art. 969/033 Cat. Must

Giselle mit Volant

- 1 Doppelbett Giselle 160x200 mit Faltenvolant art. A64/015 Cat. Must
- 2 Kissen für Kopfteil mit Knöpfen Swarovsky art. A64/015 Cat. Must
- 2 Nackenrollen mit Knöpfen Swarovsky 80 cm art. 990/020 Cat. Raso
- 1 Gesteppter Quilt 160 cm Doppelnaht art. A64/015 Cat. Must
- 1 Glatte Tagesdecke für Doppelbett 160 cm art. B52/011 Cat. E
- 1 Daunendecke 160x140 cm art. 905/037 Cat. Must
- 1 Plaid aus Kaninfell 120x180 cm art. A64/015 Cat. Must
- 1 Kissen 50x30 cm mod. B mit Knöpfen Swarovsky art. 969/054 Cat. Must
- 1 Kissen 70x40 cm mod. B mit Knöpfen mit bezogenem Rand art. 969/062 Cat. Must
- 1 Kissen 70x40 cm mod. B mit Knöpfen mit bezogenem Rand art. B43/007 Cat. Must
- 1 Kissen 50x30 cm mod. B mit Knöpfen mit bezogenem Rand art. 969/028 Cat. Must
- 1 Kissen 50x30 cm mod. B art. 969/033 Cat. Must

Giselle avec couvre-sommier

- 1 Lit Giselle deux-places 160x200 avec couvre-sommier à bords art. A64/015 Cat. Must
- 2 Oreillers couvre-tête avec boutons Swarovsky art. A64/015 Cat. Must
- 2 Traversin avec bouton Swarovsky de 80 cm art. 990/020 Cat. Raso
- 1 Quilt deux-places de 160 cm surpiqué baguette art. A64/015 Cat. Must
- 1 Couvre-lit lisse deux-places de 160 cm art. B52/011 Cat. E
- 1 Couette 160x140 cm art. 905/037 Cat. E
- 1 Plaid peau Lapin 120x180 cm art. A64/015 Cat. Must
- 1 Oreiller 50x30 cm mod. B avec boutons Swarovsky art. A64/015 Cat. Must
- 1 Oreiller 70x40 cm mod. B avec boutons bord revêtu et boutons art. 969/054 Cat. Must
- 1 Oreiller 70x40 cm mod. B avec boutons bord revêtu et boutons art. 969/062 Cat. Must
- 1 Oreiller 70x40 cm mod. B avec boutons bord revêtu et boutons art. B43/007 Cat. Must
- 1 Oreiller 50x30 cm mod. B art. 969/028 Cat. Must
- 1 Oreiller 50x30 cm mod. B art. 969/033 Cat. Must

Medea h.22

- 1 Double bed Medea 160x200 h.22 with double-pleat edge foot PIE7IT art. B53/001 Cat. Must
- 2 Roll cushions with zipper and double-pleat edge 80 cm art. 969/033 Cat. Must
- 1 Double-bed quilt 160 cm square quilting 5x5 art. 990/020 Cat. Raso
- 1 Double-bed quilt 160 cm baguette quilting art. 969/050 Cat. Must
- 1 Duvet 160x140 cm art. 905/017 Cat. E
- 1 Blanket in Lapin fur 120x180 cm art. 515XFDCA000002 Cat. C
- 1 Superfine Merino wool blanket with fringes 130x180 cm art. A38/027 Cat. C
- 1 Cushion 50x30 cm mod. B with buttons with double-pleat edge and button art. 969/033 Cat. Must
- 1 Cushion 50x30 cm mod. B art. 969/050 Cat. Must
- 1 Cushion 50x50 cm mod. B art. B53/001 Cat. Must
- 1 Cushion 50x50 cm mod. B with double-pleat edge art. 969/033 Cat. Must
- 1 Cushion 50x30 cm mod. B with double-pleat edge art. B53/001 Cat. Must
- 1 Cushion 70x40 cm mod. B with buttons with double-pleat edge and buttons art. B53/001 Cat. C
- 1 Table Habille' art. 969/054 Cat. Must
- 1 Armchair Tea art. 969/033 Cat. Must

Medea h.22

- 1 Doppelbett Medea 160x200 h.22 avec bord revêtu Fuß PIE7IT art. B53/001 Cat. Must
- 2 Nackenrollen mit Reißverschluss und bezogenem Rand 80 cm art. 969/033 Cat. Must
- 1 Gesteppterquilt 5x5 für Doppelbett 160 cm art. 969/033 Cat. Must
- 1 Quilt für Doppelbett 160 cm Doppelnahtsteppung art. 990/020 Cat. Raso
- 1 Daunendecke 160x140 cm art. 969/050 Cat. Must
- 1 Plaid aus Kaninfell 120x180 cm art. 905/017 Cat. E
- 1 Plaid superfine Merinowolle mit Fransen 130x180 cm art. 515XFDCA000002 Cat. C
- 1 Kissen 50x30 cm mod. B mit Knöpfen mit bezogenem Rand art. 969/033 Cat. Must
- 1 Kissen 50x30 cm mod. B art. 969/033 Cat. Must
- 1 Kissen 50x50 cm mod. B art. 969/050 Cat. Must
- 1 Kissen 50x50 cm mod. B mit bezogenem Rand art. B53/001 Cat. Must
- 1 Kissen 50x30 cm mod. B mit bezogenem Rand art. 969/033 Cat. Must
- 1 Kissen 50x30 cm mod. B mit bezogenem Rand art. B53/001 Cat. Must
- 1 Kissen 70x40 cm mod. B mit Knöpfen mit bezogenem Rand art. 969/033 Cat. Must
- 1 Kissen 70x40 cm mod. B mit Knöpfen mit bezogenem Rand art. B53/001 Cat. C
- 1 Table Habille' art. 969/054 Cat. Must
- 1 Sessel Tea art. 969/033 Cat. Must

Medea h.22

- 1 Lit Medea deux-places 160x200 h.22 avec bord revêtu pied PIE7IT art. B53/001 Cat. Must
- 2 Traversin avec fermeture éclair et bord revêtu de 80 cm art. 969/033 Cat. Must
- 1 Quilt deux-places de 160 cm surpiqué carré 5x5 art. 990/020 Cat. Raso
- 1 Quilt deux-places de 160 cm surpiqué baguette art. 969/050 Cat. Must
- 1 Couette 160x140 cm art. 905/017 Cat. E
- 1 Plaid peau Lapin 120x180 cm art. 905/017 Cat. E
- 1 Plaid laine merinos superfine avec frange 130x180 cm art. 515XFDCA000002 Cat. C
- 1 Oreiller 50x30 cm mod. B avec boutons bord revêtu et boutons art. A38/027 Cat. C
- 1 Oreiller 50x30 cm mod. B art. 969/033 Cat. Must
- 1 Oreiller 50x50 cm mod. B art. 969/050 Cat. Must
- 1 Oreiller 50x50 cm mod. B art. B53/001 Cat. Must
- 1 Oreiller 50x30 cm mod. B bord revêtu art. 969/033 Cat. Must
- 1 Oreiller 50x30 cm mod. B bord revêtu art. B53/001 Cat. Must
- 1 Oreiller 70x40 cm mod. B avec boutons bord revêtu et boutons art. 969/033 Cat. Must
- 1 Table Habillé art. A38/027 Cat. C
- 1 Fauteuil Tea art. 969/033 Cat. Must



Anastasia h.28

Pag 103

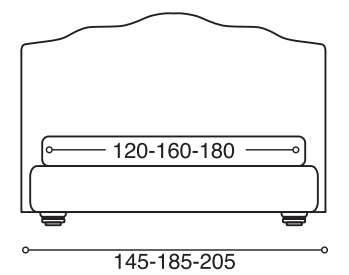
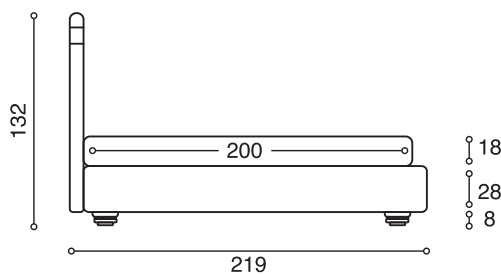

Anastasia h.28

- 1 Letto Anastasia matrimoniale 160x200 h.28 piede PIE28N art. 969/053 Cat. Must
- 2 Rollò con bottone e bordo rivestito da 80 cm art. 969/053 Cat. Must
- 1 Quilt matrimoniale da 160 cm trapuntato 5x5 art. 969/027 Cat. Must
- 1 Copriletto liscio matrimoniale da 160 cm art. 969/033 Cat. Must
- 1 Copriletto liscio matrimoniale da 160 cm art. B43/009 Cat. Must
- 1 Plaid pelliccia Lapin 120x180 cm art. 905/017 Cat. E
- 1 Cuscino 60x60 cm mod. B art. B16/003 Cat. C
- 1 Cuscino 60x60 cm mod. B art. 969/054 Cat. Must
- 1 Cuscino 50x50 cm mod. B art. 969/027 Cat. Must
- 1 Cuscino 50x50 cm mod. B art. 969/053 Cat. Must
- 1 Cuscino 50x30 cm mod. B art. 969/053 Cat. Must
- 1 Cuscino 70x40 cm mod. B con bottoni art. 969/053 Cat. Must
- 1 Cuscino 70x40 cm mod. B con bottoni bordo e bottone art. 969/028 Cat. Must
- 1 Cuscino 50x50 cm con fiocchi art. B43/011 +009 Cat. Must
- 1 Pouf rotondo ø 70 cm art. 969/053 Cat. Must

Anastasia h.28

- 1 Double bed Anastasia 160x200 h.28 foot PIE28N art. 969/053 Cat. Must
- 2 Roll cushions with button and double-pleat edge 80 cm art. 969/053 Cat. Must
- 1 Double quilt 5x5 160 cm art. 969/033 Cat. Must
- 1 Plain double bedspread 160 cm art. B43/009 Cat. Must
- 1 Blanket in Lapin fur 120x180 cm art. 905/017 Cat. E
- 1 Cushion 60x60 cm mod. B art. B16/003 Cat. C
- 1 Cushion 60x60 cm mod. B with double-pleat edge and back art. 969/054 Cat. Must
- 1 Cushion 50x50 cm mod. B with double-pleat edge art. 969/027 Cat. Must
- 1 Cushion 50x30 cm mod. B with buttons art. 969/053 Cat. Must
- 1 Cushion 70x40 cm mod. B with buttons edge and buttons art. 969/028 Cat. Must
- 1 Cushion 50x50 cm with ribbons art. B43/011 +009 Cat. Must
- 1 Round pouf ø 70 cm art. 969/053 Cat. Must

Anastasia h.28

- 1 Doppelbett Anastasia 160x200 h.28 Fuß PIE28N art. 969/053 Cat. Must
- 2 Nackenrollen mit Knopf und bezogenem Rand 80 cm art. 969/053 Cat. Must
- 2 Roll cushions with button and bezogenem Rand 80 cm art. 969/027 Cat. Must
- 1 Gesteppter Quilt 5x5 für Doppelbett 160 cm art. 969/033 Cat. Must
- 1 Glatte Tagesdecke für Doppelbett 160 cm art. B43/009 Cat. Must
- 1 Plaid aus Kaninfell 120x180 cm art. 905/017 Cat. E
- 1 Kissen 60x60 cm mod. B art. B16/003 Cat. C
- 1 Kissen 60x60 cm mod. B mit bezogenem Rand art. 969/054 Cat. Must
- 1 Kissen 50x50 cm mod. B mit bezogenem Rand art. 969/027 Cat. Must
- 1 Kissen 50x30 cm mod. B mit Knöpfen art. 969/053 Cat. Must
- 1 Kissen 70x40 cm mod. B mit Knöpfen Rand und Knöpfen art. 969/028 Cat. Must
- 1 Kissen 50x50 cm mit Schleifen art. B43/011 +009 Cat. Must
- 1 Runder Pouf ø 70 cm art. 969/053 Cat. Must

Anastasia h.28

- 1 Lit Anastasia deux-places 160x200 h.28 pied PIE28N art. 969/053 Cat. Must
- 2 Traversin avec bouton et bord revêtu de 80 cm art. 969/053 Cat. Must
- 2 Oreillers avec bouton art. 969/027 Cat. Must
- 1 Quilt deux-places de 160 cm surpiqué 5x5 art. 969/033 Cat. Must
- 1 Couvre-lit lisse deux-places de 160 cm art. B43/009 Cat. Must
- 1 Plaid peau Lapin 120x180 cm art. 905/017 Cat. E
- 1 Oreiller 60x60 cm mod. B art. B16/003 Cat. C
- 1 Oreiller 60x60 cm mod. B bord revêtu et arrière art. 969/054 Cat. Must
- 1 Oreiller 50x50 cm mod. B art. 969/027 Cat. Must
- 1 Oreiller 50x30 cm mod. B art. 969/053 Cat. Must
- 1 Oreiller 70x40 cm mod. B avec boutons bord et boutons art. 969/028 Cat. Must
- 1 Oreiller 50x50 cm avec nœuds art. B43/011 +009 Cat. Must
- 1 Pouf rond ø 70 cm art. 969/053 Cat. Must



Anastasia con gonna

Pag 107

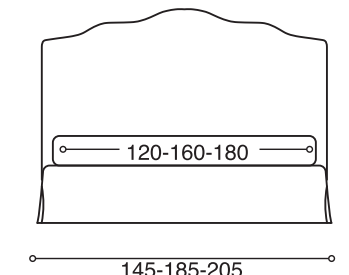
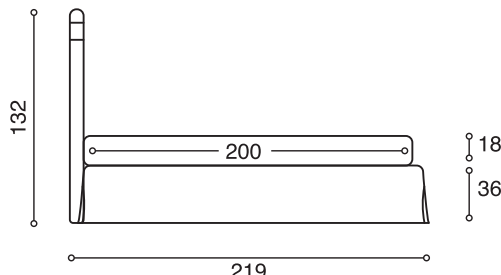

Anastasia con gonna

- 1 Letto Anastasia matrimoniale 180x200 con gonna art. B47/001 Cat. Must
- 2 Rollò con bottone da 90 cm art. B48/001 Cat. Must
- 1 Quilt matrimoniale da 180 cm trapuntato 15x15 art. B49/001 Cat. Must
- 1 Piumotto 160x140 cm art. B47/001 Cat. Must
- 1 Plaid Cashmere Tricot Treccia 150x175 cm art. 514XNGC000001 Cat. Must
- 1 Cuscino 60x60 cm mod. Q art. B49/001 Cat. Must
- 1 Cuscino 60x60 cm mod. T art. B49/003 Cat. Must
- 1 Cuscino 60x60 cm mod. B art. 969/026 Cat. Must
- 1 Cuscino 60x60 cm mod. B art. 969/004 Cat. Must
- 1 Cuscino 70x40 cm mod. Q con bottoni art. B47/001 Cat. Must
- 1 Cuscino 60x60 cm mod. L art. 990/023 Cat. Must
- 1 Panchetta Louise art. 831/106 Cat. E Plus

Anastasia with skirt

- 1 Double bed Anastasia 180x200 with skirt art. B47/001 Cat. Must
- 2 Roll cushions with button 90 cm art. B48/001 Cat. Must
- 1 Double quilt 15x15 180 cm art. B49/001 Cat. Must
- 1 Duvet 160x140 cm art. B47/001 Cat. Must
- 1 Cashmere blanket Pleat Tricot 150x175 cm art. 514XNGC000001 Cat. Must
- 1 Cushion 60x60 cm mod. Q art. B49/001 Cat. Must
- 1 Cushion 60x60 cm mod. T art. B49/003 Cat. Must
- 1 Cushion 60x60 cm mod. B art. 969/026 Cat. Must
- 1 Cushion 60x60 cm mod. B art. 969/004 Cat. Must
- 1 Cushion 70x40 cm mod. Q with buttons art. B47/001 Cat. Must
- 1 Cushion 60x60 cm mod. L art. 990/023 Cat. Must
- 1 Bench Louise art. 831/106 Cat. E Plus

Anastasia mit Volant

- 1 Doppelbett Anastasia 180x200 mit Volant art. B47/001 Cat. Must
- 2 Nackenrollen mit Knopf 90 cm art. B48/001 Cat. Must
- 1 Gesteppter Quilt 15x15 für Doppelbett 180 cm art. B49/001 Cat. Must
- 1 Daunendecke 160x140 cm art. B47/001 Cat. Must
- 1 Plaid aus Cashmere Tricot Treccia 150x175 cm art. 514XNGC000001 Cat. Must
- 1 Kissen 60x60 cm mod. Q art. B49/001 Cat. Must
- 1 Kissen 60x60 cm mod. T art. B49/003 Cat. Must
- 1 Kissen 60x60 cm mod. B art. 969/026 Cat. Must
- 1 Kissen 60x60 cm mod. B art. 969/004 Cat. Must
- 1 Kissen 70x40 cm mod. Q mit Knöpfen art. B47/001 Cat. Must
- 1 Kissen 60x60 cm mod. L art. 990/023 Cat. Must
- 1 Sessel Louise art. 831/106 Cat. E Plus

Anastasia avec couvre-sommier

- 1 Lit Anastasia deux-places 180x200 avec couvre-sommier art. B47/001 Cat. Must
- 2 Traversin avec bouton de 90 cm art. B48/001 Cat. Must
- 1 Quilt deux-places de 180 cm surpiqué 15x15 art. B49/001 Cat. Must
- 1 Couette 160x140 cm art. B47/001 Cat. Must
- 1 Plaid Cashmere Tricot Tresse 150x175 cm art. 514XNGC000001 Cat. Must
- 1 Oreiller 60x60 cm mod. Q art. B49/001 Cat. Must
- 1 Oreiller 60x60 cm mod. T art. B49/003 Cat. Must
- 1 Oreiller 60x60 cm mod. B art. 969/026 Cat. Must
- 1 Oreiller 60x60 cm mod. B art. 969/004 Cat. Must
- 1 Oreiller 70x40 cm mod. Q avec boutons art. B47/001 Cat. Must
- 1 Oreiller 60x60 cm mod. L art. 990/023 Cat. Must
- 1 Banquette Louise art. 831/106 Cat. E Plus



Marlene Boiserie con cornice

Pag 115

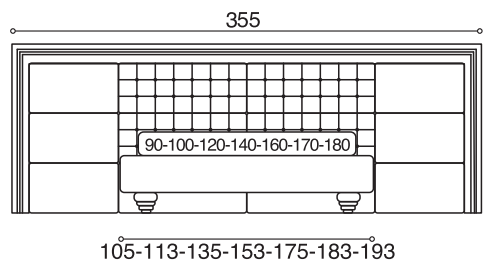
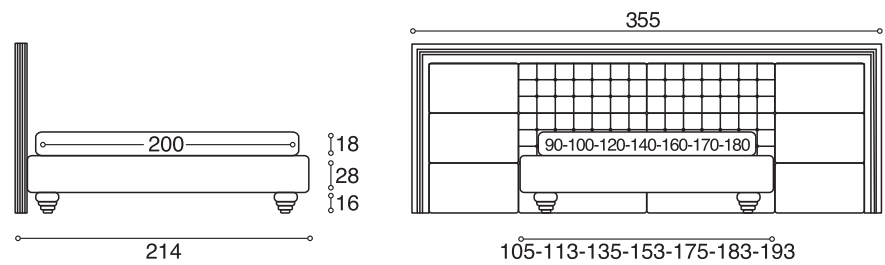

Marlene Boiserie con cornice e Sommier Max h.28

- | | | |
|--|--------------|-------------|
| 1 Letto Sommier matrimoniale Max 180x200 h.28 piedi PIE64W | art. 843/002 | Cat. E Plus |
| 4 Pannelli capitonne' 97.5x38 cm con bottoni Swarovsky | art. 843/002 | Cat. E Plus |
| 2 Pannelli 97.5x38 cm | art. 843/002 | Cat. E Plus |
| 6 Pannelli 65x38 cm | art. 843/002 | Cat. E Plus |
| 2 Mensola porta oggetti 65x20 cm | art. 906/012 | Cat. E |
| 1 Cornice | art. 843/002 | Cat. E Plus |
| 1 Quilt matrimoniale 180 cm trapuntato baguette | art. 990/020 | Cat. Raso |
| 1 Completo lenzuola matrimoniale da 180 cm | art. 990/020 | Cat. Raso |
| 1 Plaid pelliccia Lapin 120x180 cm | art. 905/017 | Cat. E |
| 1 Piumotto 180x140 cm | art. 969/052 | Cat. Must |
| 1 Cuscino 70x40 cm mod. T con bottoni | art. 969/054 | Cat. Must |
| 1 Cuscino 70x40 cm mod. B | art. B58/001 | Cat. E Plus |
| bordo rivestito e retro | art. 969/054 | Cat. Must |
| 1 Pouf Moon 60x60 cm | art. 843/002 | Cat. E Plus |

Marlene Boiserie with frame and Sommier Max h.28

- | | | |
|---|--------------|-------------|
| 1 Double bed Sommier Max 180x200 h.28 foot PIE64W | art. 843/002 | Cat. E Plus |
| 4 Capitonne' panels 97.5x38 cm with Swarovsky buttons | art. 843/002 | Cat. E Plus |
| 2 Panels 97.5x38 cm | art. 843/002 | Cat. E Plus |
| 6 Panels 65x38 cm | art. 843/002 | Cat. E Plus |
| 2 Shelf 65x20 cm | art. 906/012 | Cat. E |
| 1 Frame | art. 843/002 | Cat. E Plus |
| 1 Double-bed quilt 180 cm baguette quilting | art. 990/020 | Cat. Raso |
| 1 Double bed sheet + pillowcase set 180 cm | art. 990/020 | Cat. Raso |
| 1 Blanket in Lapin fur 120x180 cm | art. 905/017 | Cat. E |
| 1 Duvet 180x140 cm | art. 969/052 | Cat. Must |
| 1 Cushion 70x40 cm mod. T with buttons | art. 969/054 | Cat. Must |
| 1 Cushion 70x40 cm mod. B | art. B58/001 | Cat. E Plus |
| with double-pleat edge eand back | art. 969/054 | Cat. Must |
| 1 Pouf Moon 60x60 cm | art. 843/002 | Cat. E Plus |

Marlene Boiserie mit Rahmen und Sommier Max h.28

- | | | |
|---|--------------|-------------|
| 1 Doppelbett Sommier Max 180x200 h.28 FüÙe PIE64W | art. 843/002 | Cat. E Plus |
| 4 Platten capitonne' 97.5x38 cm mit Knöpfen Swarovsky | art. 843/002 | Cat. E Plus |
| 2 Platten 97.5x38 cm | art. 843/002 | Cat. E Plus |
| 6 Platten 65x38 cm | art. 843/002 | Cat. E Plus |
| 2 Ablagekonsole 65x20 cm | art. 906/012 | Cat. E |
| 1 Rahmen | art. 843/002 | Cat. E Plus |
| 1 Gesteptler Quilt für Doppelbett 180 cm Doppelnaht | art. 990/020 | Cat. Raso |
| 1 Bettwäsche-Garnitur für Doppelbett 180 cm | art. 990/020 | Cat. Raso |
| 1 Plaid aus Kaninfell 120x180 cm | art. 905/017 | Cat. E |
| 1 Daunendecke 180x140 cm | art. 969/052 | Cat. Must |
| 1 Kissen 70x40 cm mod. T mit Knöpfen | art. 969/054 | Cat. Must |
| 1 Kissen 70x40 cm mod. B | art. B58/001 | Cat. E Plus |
| mit bezogenem Rand und Rückseite | art. 969/054 | Cat. Must |
| 1 Pouf Moon 60x60 cm | art. 843/002 | Cat. E Plus |

Marlene Boiserie avec cadre et Sommier Max h.28

- | | | |
|---|--------------|-------------|
| 1 Lit Sommier deux-places Max 180x200 h.28 pieds PIE64W | art. 843/002 | Cat. E Plus |
| 4 Panneaux capitonné 97.5x38 cm avec boutons Swarovsky | art. 843/002 | Cat. E Plus |
| 2 Panneaux 97.5x38 cm | art. 843/002 | Cat. E Plus |
| 6 Panneaux 65x38 cm | art. 843/002 | Cat. E Plus |
| 2 Tablette porte-objets 65x20 cm | art. 906/012 | Cat. E |
| 1 Cadre | art. 843/002 | Cat. E Plus |
| 1 Quilt deux-places 180 cm surpiqué baguette | art. 990/020 | Cat. Raso |
| 1 Parure draps deux-places de 180 cm | art. 990/020 | Cat. Raso |
| 1 Plaid peau Lapin 120x180 cm | art. 905/017 | Cat. E |
| 1 Couette 180x140 cm | art. 969/052 | Cat. Must |
| 1 Oreiller 70x40 cm mod. T avec boutons | art. 969/054 | Cat. Must |
| 1 Oreiller 70x40 cm mod. B | art. B58/001 | Cat. E Plus |
| bord revêtu et arrière | art. 969/054 | Cat. Must |
| 1 Pouf Moon 60x60 cm | art. 843/002 | Cat. E Plus |



Marlene Boiserie con cornice

Pag 117

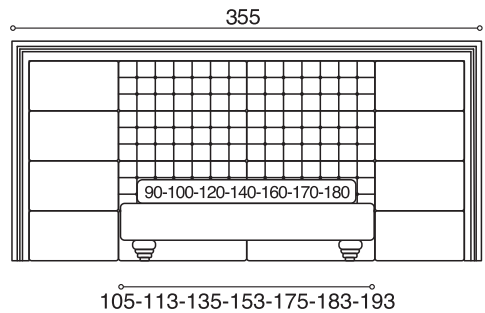
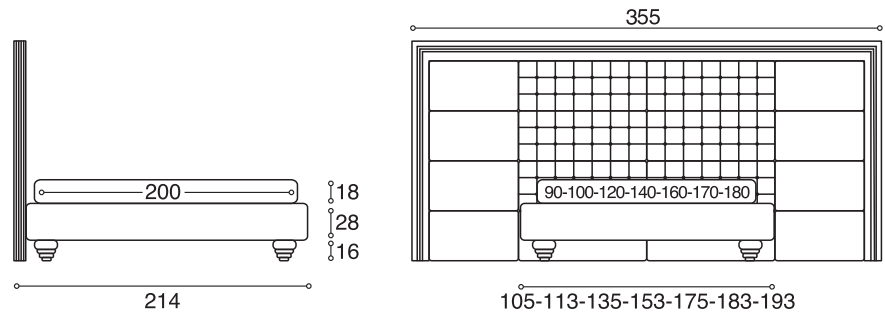

Marlene Boiserie con cornice e Sommier Max h.28

- | | | |
|--|--------------------|-------------|
| 1 Letto Sommier matrimoniale Max 180x200 h.28 piedi PIE64S | art. 843/104 | Cat. E Plus |
| 8 Pannelli 65x38 cm | art. 843/004 | Cat. E Plus |
| 6 Pannelli capitonne' 97.5x38 cm con bottoni Swarovsky | art. 843/004 | Cat. E Plus |
| 2 Pannelli 97.5x38 cm | art. 843/004 | Cat. E Plus |
| 1 Cornice | art. 843/004 | Cat. E Plus |
| 1 Quilt matrimoniale 180 cm trapuntato 5x5 cm | art. 969/033 | Cat. Must |
| 1 Trapunta matrimoniale 180 cm 200 gr. trapuntata baguette con angoli stondati | art. 786/010 | Cat. Raso |
| 1 Completo lenzuola matrimoniale da 180 cm | art. 514XOHC000002 | Cat. Raso |
| 1 Plaid Cashmere Tricot double 170x175 cm | art. B53/001 | Cat. Must |
| 1 Cuscino 70x40 cm mod. B | art. A38/027 | Cat. C |
| bordo e bottoni | art. 969/033 | Cat. Must |
| 2 Cuscini 50x50 cm mod. B | art. 969/054 | Cat. Must |
| 1 Sedia Rosita | art. 969/001 | Cat. Must |
| bordo rivestito | art. 969/054 | Cat. Must |
| 1 Table Habille' | art. 969/054 | Cat. Must |

Marlene Boiserie with frame and Sommier Max h.28

- | | | |
|--|--------------------|-------------|
| 1 Double bed Sommier Max 180x200 h.28 foot PIE64S | art. 843/104 | Cat. E Plus |
| 8 Panels 65x38 cm | art. 843/004 | Cat. E Plus |
| 6 Capitonne' panels 97.5x38 cm with Swarovsky buttons | art. 843/004 | Cat. E Plus |
| 2 Panels 97.5x38 cm | art. 843/004 | Cat. E Plus |
| 1 Frame | art. 843/004 | Cat. E Plus |
| 1 Double quilt 5x5 cm 180 cm | art. 969/033 | Cat. Must |
| 1 Double-bed quilt 180 cm 200 gr. baguette quilting with rounded corners | art. 786/010 | Cat. Raso |
| 1 Double bed sheet + pillowcase set 180 cm | art. 514XOHC000002 | Cat. Raso |
| 1 Cashmere blanket double Tricot 170x175 cm | art. B53/001 | Cat. Must |
| 1 Cushion 70x40 cm mod. B | art. A38/027 | Cat. C |
| Edge and buttons | art. 969/033 | Cat. Must |
| 2 Cushions 50x50 cm mod. B | art. 969/054 | Cat. Must |
| 1 Chair Rosita | art. 969/001 | Cat. Must |
| with double-pleat edge | art. 969/054 | Cat. Must |
| 1 Table Habille' | art. 969/054 | Cat. Must |

Marlene Boiserie mit Rahmen und Sommier Max h.28

- | | | |
|--|--------------------|-------------|
| 1 Doppelbett Sommier Max 180x200 h.28 FüÙe PIE64S | art. 843/104 | Cat. E Plus |
| 8 Platten 65x38 cm | art. 843/004 | Cat. E Plus |
| 6 Platten capitonné 97.5x38 cm mit Knöpfen Swarovsky | art. 843/004 | Cat. E Plus |
| 2 Platten 97.5x38 cm | art. 843/004 | Cat. E Plus |
| 1 Rahmen | art. 843/004 | Cat. E Plus |
| 1 Gesteptler Quilt 5X5 für Doppelbett 180 cm | art. 969/033 | Cat. Must |
| 1 Steppdecke für Doppelbett 180 cm 200 g Doppelnahtsteppung mit abgerundeten Ecken | art. 786/010 | Cat. Raso |
| 1 Bettwäsche-Garnitur für Doppelbett 180 cm | art. 514XOHC000002 | Cat. Raso |
| 1 Plaid aus Cashmere Tricot double 170x175 cm | art. B53/001 | Cat. Must |
| 1 Kissen 70x40 cm mod. B | art. A38/027 | Cat. C |
| Rand und Knöpfen | art. 969/033 | Cat. Must |
| 2 Kissen 50x50 cm mod. B | art. 969/054 | Cat. Must |
| 1 Stuhl Rosita | art. 969/001 | Cat. Must |
| mit bezogenem Rand | art. 969/054 | Cat. Must |
| 1 Table Habille' | art. 969/054 | Cat. Must |

Marlene Boiserie avec cadre et Sommier Max h.28

- | | | |
|--|--------------------|-------------|
| 1 Lit Sommier deux-places Max 180x200 h.28 pieds PIE64S | art. 843/104 | Cat. E Plus |
| 8 Panneaux 65x38 cm | art. 843/004 | Cat. E Plus |
| 6 Panneaux capitonné 97.5x38 cm avec boutons Swarovsky | art. 843/004 | Cat. E Plus |
| 2 Panneaux 97.5x38 cm | art. 843/004 | Cat. E Plus |
| 1 Cadre | art. 843/004 | Cat. E Plus |
| 1 Quilt deux-places 180 cm surpiqué 5x5 cm | art. 969/033 | Cat. Must |
| 1 Courtrepointe deux-places 180 cm 200 gr. surpiquée baguette avec angles arrondis | art. 786/010 | Cat. Raso |
| 1 Parure draps deux-places de 180 cm | art. 514XOHC000002 | Cat. Raso |
| 1 Plaid Cashmere Tricot double 170x175 cm | art. B53/001 | Cat. Must |
| 1 Oreiller 70x40 cm mod. B | art. A38/027 | Cat. C |
| bord et boutons | art. 969/033 | Cat. Must |
| 2 Oreiller 50x50 cm mod. B | art. 969/054 | Cat. Must |
| 1 Chaise Rosita | art. 969/001 | Cat. Must |
| bord revêtu | art. 969/054 | Cat. Must |
| 1 Table Habillé | art. 969/054 | Cat. Must |



Chocolat h.28

Pag 121

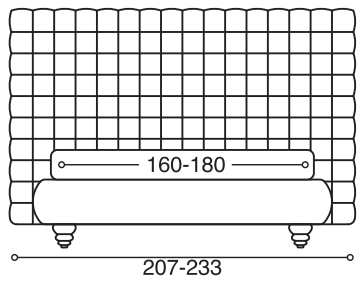
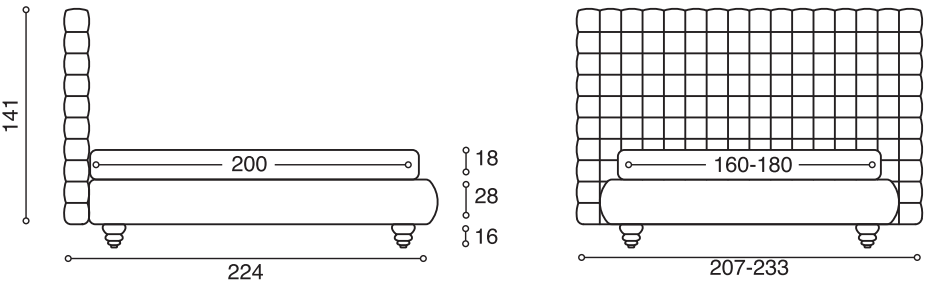

Chocolat h.28

- | | | |
|---|---------------------|-------------|
| 1 Letto Chocolat matrimoniale 180x200 h.28 piedi PIE51W | art. A45/002 | Cat. D |
| 2 Rollo' con bottone e bordo rivestito da 90 cm | art. 969/052 | Cat. Must |
| 1 Completo lenzuola matrimoniale da 180 cm | art. 990/020 | Cat. Raso |
| 1 Quilt matrimoniale da 180 cm trapuntato baguette | art. B52/011 | Cat. E |
| 1 Piumotto 180x140 cm | art. 515XFDc4000009 | Cat. E |
| 1 Plaid lana merinos con frange 130x180 cm | art. 905/017 | Cat. E |
| 1 Plaid pelliccia Lapin 120x180 cm | art. 905/037 | Cat. E |
| 1 Plaid pelliccia Lapin 120x180 cm | art. B58/001 | Cat. E Plus |
| 1 Cuscino 60x60 cm mod. B | art. B52/008 | Cat. E |
| 1 Cuscino 60x60 cm mod. B | art. 969/033 | Cat. Must |
| 1 Cuscino 50x50 cm mod. B | art. A64/024 | Cat. Must |
| 1 Cuscino 50x30 cm mod. B | art. A64/004 | Cat. Must |
| bordo rivestito | art. A64/004 | Cat. Must |

Chocolat h.28

- | | | |
|---|---------------------|-------------|
| 1 Double bed Chocolat 180x200 h.28 feet PIE51W | art. A45/002 | Cat. D |
| 2 Roll cushions with button and double-pleat edge 90 cm | art. 969/052 | Cat. Must |
| 1 Double bed sheet + 2 pillowcases 160 cm | art. 990/020 | Cat. Raso |
| 1 Double-bed quilt 180 cm baguette quilting | art. 990/020 | Cat. Raso |
| 1 Duvet 180x140 cm | art. B52/011 | Cat. E |
| 1 Merino wool blanket with fringes 130x180 cm | art. 515XFDc4000009 | Cat. E |
| 1 Blanket in Lapin fur 120x180 cm | art. 905/017 | Cat. E |
| 1 Blanket in Lapin fur 120x180 cm | art. 905/037 | Cat. E |
| 1 Cushion 60x60 cm mod. B | art. B58/001 | Cat. E Plus |
| 1 Cushion 60x60 cm mod. B | art. B52/008 | Cat. E |
| 1 Cushion 50x50 cm mod. B | art. 969/033 | Cat. Must |
| 1 Cushion 50x30 cm mod. B | art. A64/024 | Cat. Must |
| with double-pleat edge | art. A64/004 | Cat. Must |

Chocolat h.28

- | | | |
|---|---------------------|-------------|
| 1 Doppelbett Chocolat 180x200 h.28 FüÙe PIE51W | art. A45/002 | Cat. D |
| 2 Nackenrollen mit Knopf und bezogenem Rand 90 cm | art. 969/052 | Cat. Must |
| 1 Bettwäsche-Garnitur für Doppelbett 180 cm | art. 990/020 | Cat. Raso |
| 1 Gesteptler Quilt für Doppelbett 180 cm baguette | art. 990/020 | Cat. Raso |
| 1 Daunendecke 180x140 cm | art. B52/011 | Cat. E |
| 1 Plaid Merinowolle mit Fransen 130x180 cm | art. 515XFDc4000009 | Cat. E |
| 1 Plaid aus Kaninfell 120x180 cm | art. 905/017 | Cat. E |
| 1 Plaid aus Kaninfell 120x180 cm | art. 905/037 | Cat. E |
| 1 Kissen 60x60 cm mod. B | art. B58/001 | Cat. E Plus |
| 1 Kissen 60x60 cm mod. B | art. B52/008 | Cat. E |
| 1 Kissen 50x50 cm mod. B | art. 969/033 | Cat. Must |
| 1 Kissen 50x30 cm mod. B | art. A64/024 | Cat. Must |
| mit bezogenem Rand | art. A64/004 | Cat. Must |

Chocolat h.28

- | | | |
|--|---------------------|-------------|
| 1 Lit Chocolat deux-places 180x200 h.28 pieds PIE51W | art. A45/002 | Cat. D |
| 2 Traversin avec bouton et bord revêtu de 90 cm | art. 969/052 | Cat. Must |
| 1 Parure draps deux-places de 180 cm | art. 990/020 | Cat. Raso |
| 1 Quilt deux-places de 180 cm surpiqué baguette | art. 990/020 | Cat. Raso |
| 1 Couette 180x140 cm | art. B52/011 | Cat. E |
| 1 Plaid laine merinos avec frange 130x180 cm | art. 515XFDc4000009 | Cat. E |
| 1 Plaid peau Lapin 120x180 cm | art. 905/017 | Cat. E |
| 1 Plaid peau Lapin 120x180 cm | art. 905/037 | Cat. E |
| 1 Oreiller 60x60 cm mod. B | art. B58/001 | Cat. E Plus |
| 1 Oreiller 60x60 cm mod. B | art. B52/008 | Cat. E |
| 1 Oreiller 50x50 cm mod. B | art. 969/033 | Cat. Must |
| 1 Oreiller 50x30 cm mod. B | art. A64/024 | Cat. Must |
| bord revêtu | art. A64/004 | Cat. Must |



Chocolat h.28

Pag 125

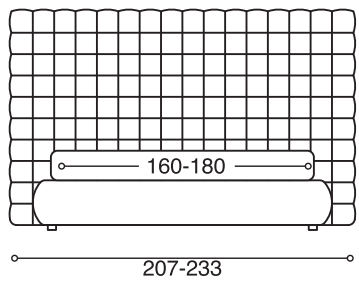
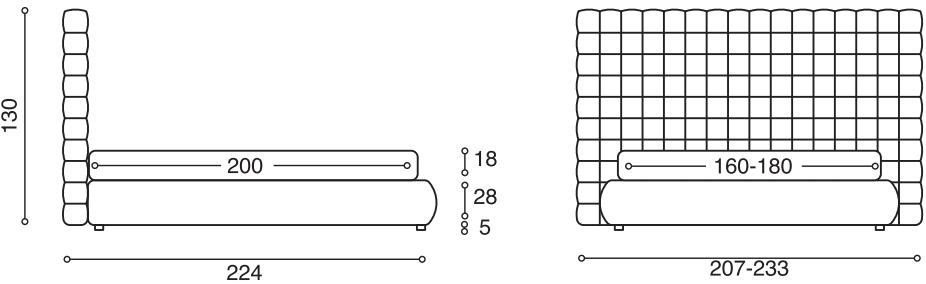

Chocolat h.28

- | | | |
|---|--------------|-------------|
| 1 Letto Chocolat matrimoniale 160x200 h.28 piedi PIE17V | art. 843/006 | Cat. E Plus |
| 2 Rollo' con cerniera da 80 cm | art. 843/006 | Cat. E Plus |
| 1 Completo copripiumino matrimoniale da 160 cm | art. 990/014 | Cat. Raso |
| 1 Trapunta matrimoniale da 160 cm 200 gr. trapuntata baguette | art. 843/011 | Cat. Must |
| 1 Piumotto 160x140 cm | art. 969/054 | Cat. Must |
| 1 Cuscino 60x60 cm mod. B | art. 969/004 | Cat. Must |
| 1 Cuscino 60x60 cm mod. B | art. 969/028 | Cat. Must |
| 1 Cuscino 50x50 cm mod. B | art. 969/054 | Cat. Must |
| 1 Cuscino 45x45 cm mod. B | art. B43/007 | Cat. Must |
| 1 Cuscino 70x40 cm mod. B con bottoni | art. B46/005 | Cat. Must |
| bordo rivestito e bottoni | art. 900/002 | Cat. Must |
| 1 Cuscino 45x45 cm mod. B | art. 969/008 | Cat. Must |
| 1 Cuscino 60x60 cm mod. T | art. 900/002 | Cat. Must |
| 1 Cuscino 45x45 cm mod. T | art. 969/028 | Cat. Must |
| 1 Cuscino 50x50 cm mod. B con bottone | art. 740/008 | Cat. D |
| bordo rivestito e bottoni | art. 969/026 | Cat. Must |
| 1 Cuscino 70x40 cm mod. B con bottone | art. 740/008 | Cat. D |
| bordo rivestito e bottoni | art. 969/026 | Cat. Must |
| 1 Pouf rotondo ø 50 cm | art. B46/005 | Cat. Must |
| 1 Pouf rotondo ø 60 cm | art. B46/005 | Cat. Must |
| 1 Poltrona Velvet | art. 969/028 | Cat. Must |
| bordo rivestito | art. 969/033 | Cat. Must |



Ludwig h.28

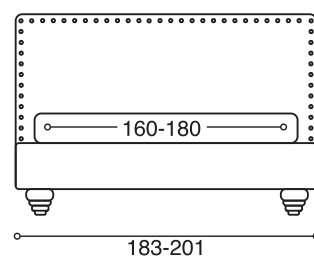
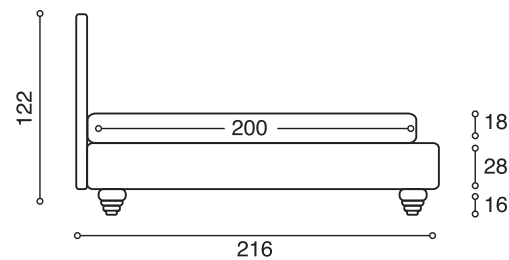

Ludwig h.28

- 1 Letto Ludwig basso matrimoniale 180x200 h.28
bottoni
piedi PIE64V art. 843/110 Cat. E Plus
- 1 Quilt matrimoniale da 180 cm trapuntato baguette art. 843/010 Cat. E Plus
- 1 Quilt matrimoniale da 180 cm trapuntato baguette art. 990/020 Cat. Raso
- 1 Quilt matrimoniale da 180 cm trapuntato baguette con angoli stondati art. 843/010 Cat. Must
- 2 Rollo' con bottone e bordo rivestito da 90 cm art. 969/051 Cat. Must
- 1 Plaid pelliccia Lapin 120x180 cm art. 905/020 Cat. E
- 1 Plaid pelliccia Lapin 120x180 cm art. 905/015 Cat. E
- 1 Cuscino 60x60 cm mod. B art. B.58/001 Cat. E Plus
- 1 Cuscino 70x40 cm mod. B art. B.58/001 Cat. E Plus
- 1 Cuscino 70x40 cm mod. B con bottoni art. 969/054 Cat. Must
- 1 Cuscino 70x40 cm mod. B con bottoni art. 969/054 Cat. Must
- 1 Cuscino 50x30 cm mod. B art. B.43/007 Cat. Must
- 1 Cuscino 50x30 cm mod. B art. B.48/003 Cat. Must
- 1 Cuscino 50x50 cm con fascia art. B.57/001 Cat. E Plus
- 1 Cuscino 50x50 cm con fascia art. B.56/001 Cat. E Plus
- 1 Panchetta Maurice art. 969/054 Cat. Must

Ludwig h.28

- 1 Double bed Ludwig low 180x200 h.28 art. 843/110 Cat. E Plus
- 1 buttons art. 843/010 Cat. E Plus
- 1 foot PIE64V
- 1 Double-bed quilt 180 cm baguette quilting art. 990/020 Cat. Raso
- 1 Double-bed quilt 180 cm baguette quilting with rounded corners art. 843/010 Cat. Must
- 2 Roll cushions with button and double-pleat edge 90 cm art. 969/051 Cat. Must
- 1 Blanket in Lapin fur 120x180 cm art. 905/020 Cat. E
- 1 Blanket in Lapin fur 120x180 cm art. 905/015 Cat. E
- 1 Cushion 60x60 cm mod. B art. B.58/001 Cat. E Plus
- 1 Cushion 70x40 cm mod. B art. B.58/001 Cat. E Plus
- 1 Cushion 70x40 cm mod. B with double-pleat edge and back art. 969/054 Cat. Must
- 1 Cushion 70x40 cm mod. B con bottoni art. 969/054 Cat. Must
- 1 Cushion 50x30 cm mod. B art. B.43/007 Cat. Must
- 1 Cushion 50x30 cm mod. B art. B.48/003 Cat. Must
- 1 Cushion 50x50 cm with band art. B.57/001 Cat. E Plus
- 1 Cushion 50x50 cm with band art. B.56/001 Cat. E Plus
- 1 Bench Maurice art. 969/054 Cat. Must

Ludwig h.28

- 1 Doppelbett Ludwig niedrig 180x200 h.28 art. 843/110 Cat. E Plus
- 1 Knöpfen art. 843/010 Cat. E Plus
- 1 Füße PIE64V
- 1 Quilt für Doppelbett 180 cm Doppelnahtsteppung art. 990/020 Cat. Raso
- 1 Quilt für Doppelbett 180 cm Doppelnahtsteppung mit abgerundeten Ecken art. 843/010 Cat. Must
- 2 Nackenrollen mit Knopf und bezogenem Rand 90 cm art. 969/051 Cat. Must
- 1 Plaid aus Kaninfell 120x180 cm art. 905/020 Cat. E
- 1 Plaid aus Kaninfell 120x180 cm art. 905/015 Cat. E
- 1 Kissen 60x60 cm mod. B art. B.58/001 Cat. E Plus
- 1 Kissen 70x40 cm mod. B art. B.58/001 Cat. E Plus
- 1 Kissen 70x40 cm mod. B mit bezogenem Rand und Rückseite art. 969/054 Cat. Must
- 1 Kissen 70x40 cm mod. B mit Knöpfen art. 969/054 Cat. Must
- 1 Kissen 50x30 cm mod. B art. B.43/007 Cat. Must
- 1 Kissen 50x30 cm mod. B art. B.48/003 Cat. Must
- 1 Kissen 50x50 cm mit Band art. B.57/001 Cat. E Plus
- 1 Kissen 50x50 cm mit Band art. B.56/001 Cat. E Plus
- 1 Sitzbank Maurice art. 969/054 Cat. Must

Ludwig h.28

- 1 Lit Ludwig bas deux-places 180x200 h.28 art. 843/110 Cat. E Plus
- 1 boutons art. 843/010 Cat. E Plus
- 1 pieds PIE64V
- 1 Quilt deux-places de 180 cm surpiqué baguette art. 990/020 Cat. Raso
- 1 Quilt deux-places de 180 cm surpiqué baguette avec angles arrondis art. 843/010 Cat. Must
- 2 Traversin' avec bouton et bord revêtu de 90 cm art. 969/051 Cat. Must
- 1 Plaid peau Lapin 120x180 cm art. 905/020 Cat. E
- 1 Plaid peau Lapin 120x180 cm art. 905/015 Cat. E
- 1 Oreiller 60x60 cm mod. B art. B.58/001 Cat. E Plus
- 1 Oreiller 70x40 cm mod. B art. B.58/001 Cat. E Plus
- 1 Oreiller 70x40 cm mod. B bord revêtu et arrière art. 969/054 Cat. Must
- 1 Oreiller 70x40 cm mod. B avec boutons art. 969/054 Cat. Must
- 1 Oreiller 50x30 cm mod. B art. B.43/007 Cat. Must
- 1 Oreiller 50x30 cm mod. B art. B.48/003 Cat. Must
- 1 Oreiller 50x50 cm avec bande art. B.57/001 Cat. E Plus
- 1 Oreiller 50x50 cm avec bande art. B.56/001 Cat. E Plus
- 1 Banquette Maurice art. 969/054 Cat. Must



Poltrona Velvet / Panchetta Louise



Poltrona Grand Hotel

Pouf Soft Rotondo

Tessuto art. 969/062 Cat. Must

Panchetta Carmen

Fabric art. 969/033 Cat. Must

bordo art. 969/028 Cat. Must

Panchetta Maurice

Tessuto art. 969/054 Cat. Must

Poltrona Velvet

Tessuto art. 969/003 Cat. Must

bordo art. 969/031 Cat. Must

Panchetta Louise

Tessuto art. B.20/010 Cat. Must

Poltrona Grand Hotel

Tessuto art. 832/001 Cat. E

Pouf Soft Rotondo

Fabric art. 969/062 Cat. Must

Bench Carmen

Fabric art. 969/033 Cat. Must

Covered edge art. 969/028 Cat. Must

Bench Maurice

Fabric art. 969/054 Cat. Must

Armchair Velvet

Fabric art. 969/003 Cat. Must

Covered edge art. 969/031 Cat. Must

Bench Louise

Fabric art. B.20/010 Cat. Must

Armchair Grand Hotel

Fabric art. 832/001 Cat. E

Pouf Soft Rotondo

Gewebe art. 969/062 Kat. Must

Bankelement Carmen

Gewebe art. 969/033 Kat. Must

Bezogenem Rand art. 969/028 Kat. Must

Bankelement Maurice

Gewebe art. 969/054 Kat. Must

Sessel Velvet

Gewebe art. 969/003 Kat. Must

Bezogenem Rand art. 969/031 Kat. Must

Bankelement Louise

Gewebe art. B.20/010 Kat. Must

Sessel Grand Hotel

Gewebe art. 832/001 Kat. E

Pouf Soft Rotondo

Tissu art. 969/062 Cat. Must

Banquette Carmen

Tissu art. 969/033 Cat. Must

Bande art. 969/028 Cat. Must

Banquette Maurice

Tissu art. 969/054 Cat. Must

Fauteuil Velvet

Tissu art. 969/003 Cat. Must

Bande art. 969/031 Cat. Must

Banquette Louise

Tissu art. B.20/010 Cat. Must

Fauteuil Grand Hotel

Tissu art. 832/001 Cat. E



Poltrona Mami



Poltrona Zoe



Panchetta Louise & Poltrona Kondi

Poltrona Mami

Tessuto art. A.64/001 Cat. Must

Poltrona Zoe

Tessuto art. A.64/001 Cat. Must

Panchetta Louise

Tessuto art. 831/106 Cat. E Plus

Poltrona Kondi

Tessuto art. A.07/012 Cat. Must

Armchair Mami

Gewebe art. A.64/001 Cat. Must

Armchair Zoe

Fabric art. A.64/001 Cat. Must

Bench Louise

Fabric art. 831/106 Cat. E Plus

Armchair Kondi

Fabric art. A.07/012 Cat. Must

Sessel Mami

Gewebe art. A.64/001 Kat. Must

Sessel Zoe

Gewebe art. A.64/001 Kat. Must

Bankelement Louise

Gewebe art. 831/106 Kat. E Plus

Sessel Kondi

Gewebe art. A.07/012 Kat. Must

Fauteuil Mami

Tissu art. A.64/001 Cat. Must

Fauteuil Zoe

Tissu art. A.64/001 Cat. Must

Banquette Louise

Tissu art. 831/106 Cat. E Plus

Fauteuil Kondi

Tissu art. A.07/012 Cat. Must



Pouf Soft Rotondo



Cocò

Rosita



Poltrona Tea



Poltrona Velvet

Pouf Rotondo

Tessuto art. 969/008 Cat. Must

Tessuto art. 969/027 Cat. Must

Tessuto art. 969/062 Cat. Must

Sedia Cocò

Tessuto art. 969/027 Cat. Must

Sedia Rosita

Tessuto art. 969/054 Cat. Must

bordo art. 969/001 Cat. Must

Poltrona Tea

Tessuto art. 969/033 Cat. Must

Poltrona Velvet

Tessuto art. 969/028 Cat. Must

bordo art. 969/033 Cat. Must

Pouf Rotondo

Gewebe art. 969/008 Cat. Must

Fabric art. 969/027 Cat. Must

Fabric art. 969/062 Cat. Must

Chair Cocò

Fabric art. 969/027 Cat. Must

Chair Rosita

Fabric art. 969/054 Cat. Must

Covered edge art. 969/001 Cat. Must

Armchair Tea

Fabric art. 969/033 Cat. Must

Armchair Velvet

Fabric art. 969/028 Cat. Must

Covered edge art. 969/033 Cat. Must

Pouf Rotondo

Gewebe art. 969/008 Kat. Must

Gewebe art. 969/027 Kat. Must

Gewebe art. 969/062 Kat. Must

Stuhl Cocò

Gewebe art. 969/027 Kat. Must

Stuhl Rosita

Gewebe art. 969/054 Kat. Must

Bezogenem Rand art. 969/001 Kat. Must

Sessel Tea

Gewebe art. 969/033 Kat. Must

Sessel Velvet

Gewebe art. 969/028 Kat. Must

Bezogenem Rand art. 969/033 Kat. Must

Pouf Rotondo

Tissu art. 969/008 Cat. Must

Tissu art. 969/027 Cat. Must

Tissu art. 969/062 Cat. Must

Chaise Cocò

Tissu art. 969/027 Cat. Must

Chaise Rosita

Tissu art. 969/054 Cat. Must

Bande art. 969/001 Cat. Must

Fauteuil Tea

Tissu art. 969/033 Cat. Must

Fauteuil Velvet

Tissu art. 969/028 Cat. Must

Bande art. 969/033 Cat. Must

Art director & coordinator textile: Arch. Silvia Prevedello

Concept: Sintony

Photo: Paolo Golumelli for Sintony

Styling: Meri Scarpante

Print: Grafiche Vianello

Le tonalità delle riproduzioni fotografiche sono puramente indicative. Per un'esatta scelta si deve fare riferimento al campionario colori.

The colour shades in the pictures are merely indicative. For a precise choice in is necessary to refer to the colour samples.

Die Farbtöne der Fotos sind nicht richtungsgebend, die genaue Farbwahl sollte durch die Farbkarte erfolgen.

Les tonalités des reproductions photographiques sont purement indicatives. Pour un choix exact, faire référence aux échantillons de couleurs.

Twils®

è un marchio VENETA CUSCINI s.r.l.

Via degli Olmi, 5 - 31040 Cessalto (TV)

Tel. +39 0421 469011 R.A.

Tel. +39 0421 469090 uff. comm.

Tel. +39 0421 469050 uff. sped.

Fax +39 0421 327916

www.twils.it info@twils.it