

x21

porada



x 21

porada

porada XXI

- 6 BACKSTAGE** specchio *mirror*  
**10 BEAM** tavolo *table*  
**14 BABY** tavolino/comodino *side/night table*  
**16 CHIBA** tavolino *coffee table*  
**20 COPINE BERGERE** poltrona *armchair*  
**24 COQUET** tavolino *side/coffee table*  
**30 CUCÙ** tavolino *side table*  
**34 EKERO MIRROR** specchio *mirror*  
**36 EKERO RACK** servomuto *valet stand*  
**38 EKERO XL ROUND 80** tavolino *coffee table*  
**40 GAMEN** paravento *screen*  
**44 GLADKO** armadio *wardrobe*  
**48 INFINITY TAVOLO** tavolo *table*  
**50 INFINITY TAVOLINO** tavolino *coffee table*  
**52 IONIS** sedia *chair*  
**54 KEPLER** scrittoio *desk*  
**56 KOSTER CONSOLE** console *console*  
**58 LAGOM** pouf *pouf*  
**64 LEAF** tavolino *side/coffee table*  
**70 MY SUITE** cabina armadio *walk-in closet*  
**84 NARA** comodino/cassettiera *night table/chest of drawers*  
**90 NYAN** letto *bed*  
**92 PEBBLE** credenza *sideboard*  
**96 PLISSÈ** specchio *mirror*  
**98 SOFTBAY BED** letto *bed*  
**102 SOFTBAY POLTRONA** poltrona *armchair*  
**106 STYLO** scrittoio *desk*

porada XXI

“

**De nihilo  
nihilum,  
in nihilum  
nil posse  
reverti.**

”

**Aulo Persio Flacco**

# BACKSTAGE

NAVA & AROSIO

Specchio da parete con cornice in massello di noce canaletta. Sul retro dello specchio sono presenti un ripiano svuotatasche in noce canaletta e una barra appenderia rivestita in Cuoietto. Possibilità di aggiungere fino a 3 grucce in legno con o senza clip.

*Wall mirror with frame in solid canaletta walnut. On the back of the mirror there is a coin tray in canaletta walnut and a hanging bar covered by Cuoietto leather. It is possible to add up to 3 hangers, with or without clip.*



BACKSTAGE canaletta walnut - cuoietto invecchiato - grey pewter metal







porada XXI

# BEAM

G. & O. BURATTI

Tavolo da pranzo con due basi a mezzaluna in noce canaletta unite da una trave centrale in legno. Piano in cristallo trasparente, legno, Rock o marmo e puntali in metallo.

*Dining table with two half-moon bases in canaletta walnut joined by a wooden beam. Top in clear glass, wood, Rock or marble and metal end-feet.*





**BEAM BOTTE C 260x110** canaletta walnut - black chromed metal - clear glass  
**SVEVA** ash wengè stained - cuoietto black - Pelle Plus 14 (cat. PLUS)  
**ATLANTE 3** ash wengè stained - black Sahara noir marble  
**BOLLA** ash wengè stained - white opal glass  
**TORII** ash wengè stained



porada XXI

# BABY

T. COLZANI

**BABY** canaletta walnut - brushed bronzed brass metal  
**SOFTBAY BED 180** canaletta walnut - Bouclage 01/2 (cat. B)



Tavolino o comodino con piano con cassetto in noce canaletta e base in metallo.

*Side or night table with top with drawer in canaletta walnut and metal base.*



BABY argilla matt lacquered closed pore - matt black metal  
ZIGGY BED 180 canaletta walnut - lkat 13696/08 (cat. C)



porada XXI

# CHIBA

D. DOLCINI



Tavolini in noce canaletta con base metallica realizzata in esclusiva tramite pressofusione di alluminio, finitura nero opaco. Dotati di due cassetti.

*Coffee tables in canaletta walnut with matt black metal base, obtained from company designed die casting. Equipped with two drawers.*

CHIBA 80 canaletta walnut - matt black metal  
HALO 60 white Carrara marble - grey pewter metal  
ABACUS canaletta walnut - brushed brass metal - Tress 803 (cat. D)





CHIBA 120 canaletta walnut - matt black metal  
ABACUS canaletta walnut - brushed brass metal - Tress 803 (cat. D)



porada XXI

# COPINE BERGERE

G. & O. BURATTI

Poltrona con struttura in metallo  
o in massello di noce canaletta  
e rivestimento nei tessuti della  
collezione.

*Armchair with metal or solid  
canaletta walnut frame and cover  
in the fabrics of the collection.*

**COPINE BERGERE STEEL** black nickel metal - Serge 159 (cat. C)  
**PILEO ALTA** canaletta walnut - grey pewter metal  
**FIRST** spessart oak







**COPINE BERGERE WOOD** canaletta walnut - Serge 159 (cat. C)  
**LEAF 60** canaletta walnut - Macassar ebony - grey Carnico marble



porada XXI

# COQUET

G. & O. BURATTI



Tavolini con struttura in metallo  
e piano in marmo.

*Side and coffee tables with metal  
frame and marble top.*

**ABACUS** canaletta walnut - brushed brass metal - Tress 803 (cat. D)  
**COQUET 160x80** black nickel metal - black Sahara noir marble





**COQUET 160x80** black nickel metal - black Sahara noir marble  
**COQUET 60** black nickel metal - white Calacatta gold marble  
**KIRK** canaletta walnut - Moleskin 42 (cat. C) - Zenith 57  
**HOTTO** ash wengè stained



porada XXI

**COQUET 40** black nickel metal - grey Carnico marble  
**COPINE BERGERE STEEL** black nickel metal - Serge 159 (cat. C)



**COQUET 60** black nickel metal - white Calacatta gold marble  
**KIRK** canaletta walnut - Pelle Plus 40 (cat. PLUS)



porada XXI

# CUCÙ

T. COLZANI

**CUCÙ** canaletta walnut wengè stained - matt black metal  
**ABACUS** canaletta walnut - brushed brass metal - Tress 803 (cat. D)



Tavolino con vassoio asportabile  
in noce canaletta e base in  
metallo.

*Side table with removable tray  
in canaletta walnut and metal  
frame.*





CUCÙ canaletta walnut - brushed bronzed brass metal  
SOFTBAY canaletta walnut - Bouclage 01/1 (cat. B)



porada XXI

“

**Ars aemula  
naturae.**

”

Apuleio

# EKERO MIRROR

TOLLGARD & CASTELLANI



Specchio con base cilindrica in marmo e cornice in massello di noce canaletta. Stelo centrale in metallo verniciato finitura grigio peltro. Dotato di gancio appendiabiti sul retro.

*Mirror with cylindrical marble base and frame in solid canaletta walnut. Central pole in grey pewter metal. Equipped with a clothes hook on the back.*

**EKERO MIRROR** canaletta walnut - grey Carnico marble - grey pewter metal  
**EKERO SQUARE h55** canaletta walnut - grey Carnico marble - matt black metal  
**LAGOM 97x56** canaletta walnut - Pelle Plus 68 (cat. PLUS) - Armam L1569/01 (cat.C)



# EKERO RACK

TOLLGARD & CASTELLANI



Servomuto in massello di noce canaletta, con base cilindrica in marmo e struttura in metallo verniciato finitura grigio peltro. Asta porta pantaloni con inserto antiscivolo in microfibra grigia e svuotatasche rivestito in Cuoietto.

*Valet stand in solid canaletta walnut with cylindrical marble base and metal frame in grey pewter finish. Trousers holder with non-slip insert in grey microfiber and coin tray covered by Cuoietto leather.*

EKERO RACK canaletta walnut - grey Carnico marble - grey pewter metal - cuoietto dark grey



porada XXI

## EKERO XL ROUND 80

TOLLGARD & CASTELLANI



Tavolino con base cilindrica in marmo , stelo centrale in metallo verniciato finitura nero opaco e piano in massello di noce canaletta con bordo in rilievo.

*Coffee table with cylindrical marble base, central pole in matt black metal and top in solid canaletta walnut with embossed edge.*



**EKERO XL ROUND 80** canaletta walnut - grey Carnico marble - matt black metal  
**COPINE WOOD** canaletta walnut - Bouclage 01/1 (cat. B)



porada XXI

# GAMEN

T. COLZANI



Paravento componibile formato da due o più moduli curvati alternati con profili in trafilato di alluminio rivestiti in noce canaletta. Struttura in metallo finitura peltro e piedini regolabili.

*Sectional screen consisting of two or more alternating curved modules with aluminum drawn bar profiles covered by canaletta walnut. Metal frame in grey pewter finish and adjustable feet.*

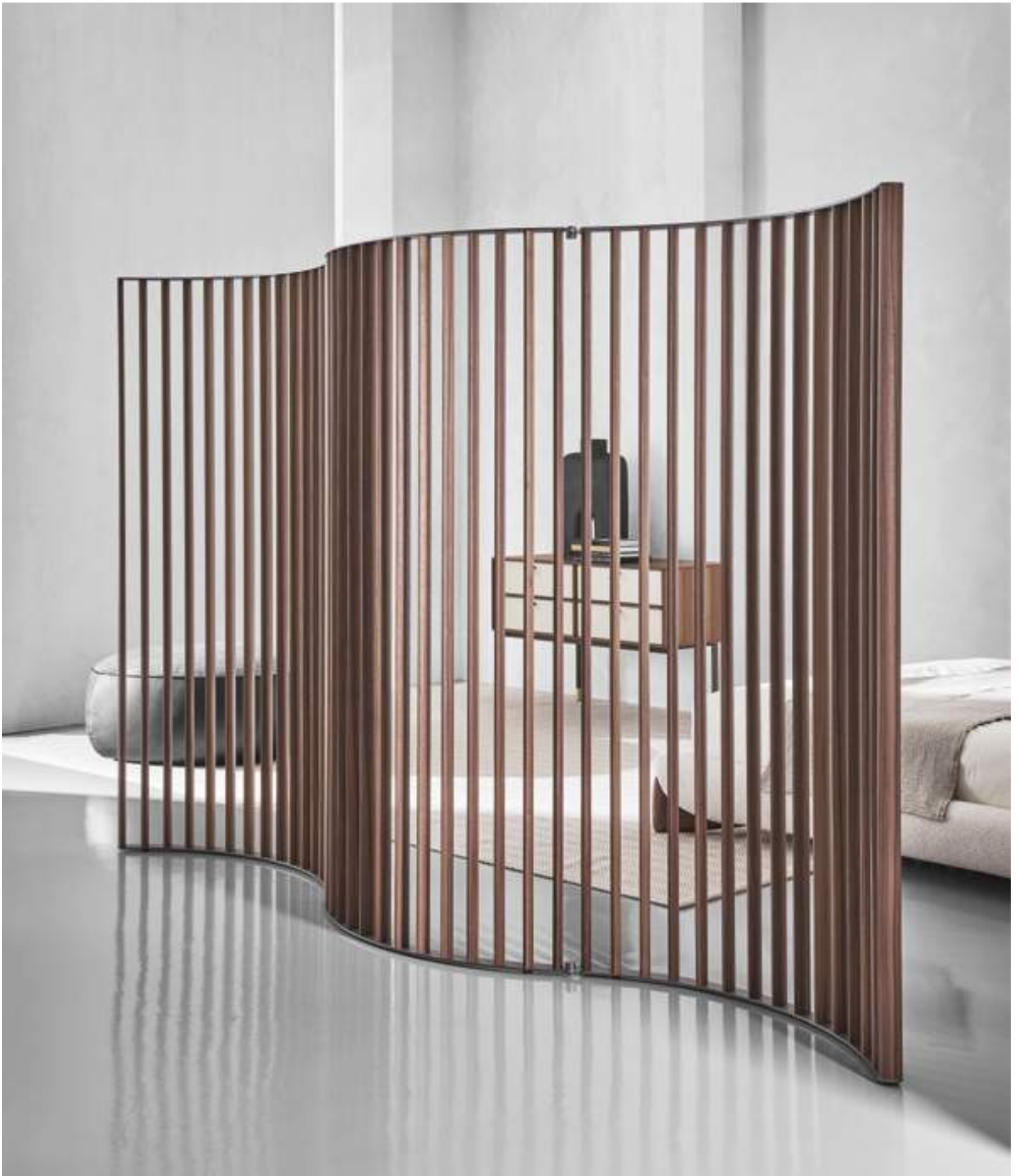



**GAMEN XXL** canaletta walnut - grey pewter metal  
**ASTRA 2** canaletta walnut - matt black metal - white opal glass  
**SHIBUMI TONDO Ø160** ash wengè stained - bronzoro  
**EVELIN WITH ARMS** ash wengè stained - Dorian 10 (cat. E) - cuoio testa di moro  
**EVELIN** ash wengè stained - Dorian 10 (cat. E)  
**TORII** ash wengè stained



# GLADKO

ESSETIPI



Armadio interamente realizzato in noce canaletta dotato di ante scorrevoli complanari con chiusura rallentata disponibili in legno o rivestite in Cuoietto nei colori della collezione, in specchio fumè acidato o in specchio naturale. Ripiani e cassetiera interni in legno e barre appenderia in metallo finitura peltro. Possibilità di aggiungere elementi divisori rivestiti in Cuoietto all'interno dei cassetti. Dotato di illuminazione a LED interna sui fianchi con sensore di apertura.

*Wardrobe entirely made of Canaletta walnut with coplanar sliding doors with soft closing system, available in wood, covered by Cuoietto leather in the colours of the collection and in clear or smoked frosted mirror. Internal shelves and chest of drawers are made of wood, while the metal hanging bars are in pewter finish. Inside the drawers it is possible to add dividers covered by Cuoietto leather. The wardrobe is provided with internal LED lighting on the sides with opening sensor.*









porada XXI

# INFINITY TAVOLO

S. BIGI



Serie di tavoli da pranzo con basi in massello di noce canaletta o frassino montate su piastre in metallo. Piani disponibili in cristallo temperato (spessore mm. 12), legno o Rock.

*Collection of dining tables with bases in solid canaletta walnut or ash mounted on metal rings. Tops available in tempered glass (thickness mm. 12), wood or Rock.*

**INFINITY OVALE C 280x120** ash grey stained - brushed matt black metal - clear glass  
**JET 4** canaletta walnut wengé stained - micro strip inlay - matt black metal  
**ESTER** ash grey stained - Motley 511 (cat. B)



# INFINITY TAVOLINO

S. BIGI



Tavolino da salotto con base in massello di noce canaletta o frassino, montata su un anello in metallo e piano in cristallo temperato (spessore mm. 10).

*Coffee table with tempered glass top (thickness mm. 10) and base in solid wood, fixed on a metal ring.*



porada XXI

# IONIS

G. & O. BURATTI

Sedia con struttura in massello di noce canaletta e rivestimento nei tessuti della collezione o in Cuoietto.

*Chair with frame in solid canaletta walnut and cover in the fabrics of the collection or in Cuoietto leather.*

IONIS canaletta walnut - Armam L1569/02 (cat. C)  
ATLANTE 3 ash wengè stained - black Sahara noir marble  
HALO 60 white Carrara marble - grey pewter metal



porada XXI

# KEPLER

G. AZZARELLO



Scrittoio in noce canaletta con due cassetti, vano portaoggetti, foro passacavi e base in metallo.

*Writing-desk in canaletta walnut with two drawers, a storage for small objects, a hole for cables management and metal base.*



**KEEPLER** canaletta walnut - brushed bronzed brass  
**SVEVA WITH ARMS** ash wengè stained - cuoietto black - Pelle Plus 14 (cat. PLUS)



porada XXI

# KOSTER CONSOLE

TOLLGARD & CASTELLANI



Console con struttura in metallo finitura Bronzoro e piano superiore in frassino o in Rock. Piano inferiore in frassino. Piedini in ottone bronzato spazzolato.

*Console with metal frame in Bronzoro finish. Upper top in Rock or in ash wood and lower top in ash wood only. End feet in brushed bronzed brass.*

**ABACUS** canaletta walnut - brushed brass metal - Tress 803 (cat. D)  
**KOSTER CONSOLE** ash wengè stained - bronzoro metal  
**ATLANTE 1** canaletta walnut - white Calacatta gold marble



porada XXI

# LAGOM

TOLLGARD & CASTELLANI



Pouf rivestiti nei tessuti della collezione con maniglia in massello noce canaletta.

*Stools covered by the fabrics of the collection with handle in solid canaletta walnut.*

**ABACUS** canaletta walnut - brushed brass metal - Tress 803 (cat. D)  
**EKERO SQUARE h55** canaletta walnut - grey Carnico marble - matt black metal  
**LAGOM 104x104** canaletta walnut - Pelle Plus 14 (cat. PLUS) - Motley 300 (cat. B)



porada XXI

**SOFTBAY** canaletta walnut - Bouclage 01/1 (cat. B)  
**LAGOM 54x54** canaletta walnut - Pelle Plus 40 (cat. PLUS) - Serge 160 (cat.C)  
**EKERO OVAL h60** canaletta walnut - grey Carnico marble - matt black metal



**LAGOM 97x56** canaletta walnut - Pelle Plus 68 (cat. PLUS) - Armam L1569/01 (cat.C)  
**EKERO OVAL h60** canaletta walnut - grey Carnico marble - matt black metal







**SOFTBAY** canaletta walnut - Bouclage 01/1 (cat. B)  
**EKERO OVAL h60** canaletta walnut - grey Carnico marble - matt black metal  
**EKERO ROUND h60** canaletta walnut - grey Carnico marble - matt black metal  
**LAGOM 54x54** canaletta walnut - Pelle Plus 40 (cat. PLUS) - Serge 160 (cat.C)  
**LAGOM 97x56** canaletta walnut - Pelle Plus 68 (cat. PLUS) - Armam L1569/01 (cat.C)  
**LAGOM 104x104** canaletta walnut - Pelle Plus 14 (cat. PLUS) - Motley 300 (cat. B)



porada XXI

# LEAF

P. JOUIN



Tavolini tondi con base in marmo grigio Carnico. Gamba centrale e piano in legno nella doppia finitura noce canaletta ed ebano Macassar.

*Side and coffee tables with grey Carnico marble base. Wooden central leg and top in the double finish canaletta walnut and Macassar ebony.*

**ARGO** canaletta walnut - black chromed metal - Armam L1569/17 (cat. C)  
**LEAF 45** canaletta walnut - Macassar ebony - grey Carnico marble  
**LEAF 60** canaletta walnut - Macassar ebony - grey Carnico marble  
**LEAF 75** canaletta walnut - Macassar ebony - grey Carnico marble







porada XXI

“

**Domus est,  
ubi cor est.**

”

**Plinio il Vecchio**

## MY SUITE

G. & O. BURATTI

Cabina armadio modulare interamente realizzata in noce canaletta con ante a battente disponibili in vetro Stopsol, con profili e maniglie in metallo finitura peltro, in legno o rivestite in Cuoietto nei colori della collezione. Completamente personalizzabile con accessori in legno, cristallo fumè o rivestiti in Cuoietto con profili in massello di noce canaletta. Gli elementi sospesi possono essere dotati di illuminazione a LED nella parte inferiore. Barre appenderia in metallo finitura peltro o rivestite in Cuoietto. Scatole e vassoi in Cuoietto e grucce in legno con o senza clip. Possibilità di aggiungere un modulo a giorno dotato di mesole con illuminazione a LED e ripiano scrittoio/coiffeuse con cassetti opzionali con frontali in legno o in Cuoietto.

*Modular walk-in closet entirely made of Canaletta walnut with hinged doors available in Stopsol glass with metal profile and handle in pewter finish, in wood or covered by Cuoietto leather in the colours of the collection. It is completely customizable with accessories in wood, smoked glass or covered by Cuoietto leather with edges in solid Canaletta walnut. The shelves can be bottom LED lighted. The metal hanging bars are in pewter finish or covered by Cuoietto leather. Wooden hangers with or without clips and leather boxes and trays are also available. It is possible to add an open module fitted with shelves with bottom LED lighting and a dressing table with optional drawers with wooden or Cuoietto leather fronts.*





**MY SUITE** canaletta walnut - cuoietto dark grey  
**AFRODITE SPECCHIO FS** canaletta walnut - brushed bronzed brass metal  
**SMILE** ash wengè stained - Motley 300 (cat. B)





**MY SUITE** canaletta walnut - cuoietto dark grey  
**AFRODITE SPECCHIO FS** canaletta walnut - brushed bronzed brass metal  
**SMILE** ash wengè stained - Motley 300 (cat. B)  
**ZIGGY NIGHT 6** canaletta walnut - grey Carnico marble  
**MIX 6** canaletta walnut



porada XXI















porada XXI

MY SUITE canaletta walnut - stopsol glass - pewter metal - cuoietto dark grey  
ASTOL ash wengè stained - bronzoro metal - Moran 102 (cat. C)







MY SUITE canaletta walnut - stopsol glass - pewter metal - cuoietto dark grey  
ZIGGY BED 180 canaletta walnut - lkat 13696/08 (cat. C)



# NARA

D. DOLCINI



Serie di comodini, cassettera e retrodivano in noce canaletta e retrodivano in noce canaletta con base metallica realizzata in esclusiva tramite pressofusione di alluminio, finitura nero opaco.

*Series of night tables, chest of drawers and back-sofa console in canaletta walnut with matt black metal base, obtained from company designed die casting.*

MIX 1 canaletta walnut  
NARA 3 canaletta walnut - matt black metal  
LUM 180 ash wengè stained - bronzoro metal - white opal glass



porada XXI

NARA 50 canaletta walnut - matt black metal  
NYAN 180 canaletta walnut - Madras 15 (cat. C)





**NARA 60** canaletta walnut - matt black metal  
**NYAN 180** canaletta walnut - Madras 15 (cat. C)



porada XXI

**SOFTBAY** canaletta walnut - Bouclage 01/1 (cat. B)  
**NARA 4** canaletta walnut - matt black metal





porada XXI

# NYAN

G. & O. BURATTI

Letto con struttura interamente realizzata in massello di noce canaletta. Testata rivestita in cuoio, cuoietto o nei tessuti della collezione.

*Bed with frame in solid canaletta walnut. Bedhead covered by Cuoio, Cuoietto leather or by the fabrics of the collection.*



**NARA 50** canaletta walnut - matt black metal  
**NYAN 180** canaletta walnut - Madras 15 (cat. C)  
**LAGOM 104x104** canaletta walnut - Pelle Plus 14 (cat. PLUS) - Motley 300 (cat. B)



# PEBBLE

N. DEVETAG

Credenza in noce canaletta con interni in frassino tinto grigio e base in metallo finitura peltro. Dotata di quattro ante e tre vani interni.

*Sideboard in canaletta walnut with inside in ash grey stained and grey pewter metal base. Equipped with four doors and three compartments.*



**PEBBLE** canaletta walnut - ash grey stained - grey pewter metal  
**BEAM BOTTE C 260x110** canaletta walnut - black chromed metal - clear glass  
**ESTER** ash grey stained - Motley 511 (cat. B)



porada XXI







porada XXI

# PLISSÈ

T. COLZANI



Specchio da parete formato da due elementi pieghevoli con retropannelli in noce canaletta. Montante centrale in massello di noce canaletta con dettagli in metallo finitura peltro.

*Wall mounted mirror with two folding elements with back in canaletta walnut. Central supporting pole in solid canaletta walnut with metal details in grey pewter finish.*

PLISSÉ canaletta walnut - grey pewter metal  
LAGOM 54x54 canaletta walnut - Pelle Plus 40 (cat. PLUS) - Serge 160 (cat.C)



porada XXI

## SOFTBAY BED

G. VIGANÒ



Letto rivestito nei tessuti della collezione con quattro piedi in massello di noce canaletta.

*Bed with cover in the fabrics of the collection and four feet in solid canaletta walnut.*

**SOFTBAY BED 180** canaletta walnut - Bouclage 01/2 (cat. B)





**BACKSTAGE** canaletta walnut - cuoietto invecchiato - grey pewter metal  
**SOFTBAY BED 180** canaletta walnut - Bouclage 01/2 (cat. B)  
**KOSTER Ø50 WOOD** ash wengè stained - bronzoro metal



porada XXI

# SOFTBAY POLTRONA

G. VIGANÒ

Poltrona rivestita nei tessuti della collezione con quattro piedi in massello di noce canaletta.

*Armchair with cover in the fabrics of the collection and four feet in solid canaletta walnut.*







**SOFTBAY** canaletta walnut - Bouclage 01/1 (cat. B)  
**SOFTBAY POLTRONA** canaletta walnut - Bouclage 01/1 (cat. B)  
**QUAY OVALE** canaletta walnut - grey Carnico marble - brushed brass metal  
**EKERO SQUARE h55** canaletta walnut - grey Carnico marble - matt black metal



# STYLO

T. COLZANI



Scrittoio con struttura in metallo, cassetto in massello di noce canaletta e piano in cristallo canaletta e piano in cristallo temperato o in legno.

*Writing-desk with metal frame, drawer in solid canaletta walnut and top in tempered glass or in wood.*

**STYLO 140** canaletta walnut - brushed bronzed brass metal - clear glass  
**PENELOPE** canaletta walnut - Serge 159 (cat. C)  
**PILEO ALTA** canaletta walnut - grey pewter metal  
**FIRST** spessart oak



porada XXI

“

**Finis  
coronat  
opus.**

”

**Latinum proverbium**





# **INFORMAZIONI TECNICHE**

## ***TECHNICAL DRAWINGS***

Porada si riserva la facoltà di modificare, in qualunque momento e senza preavviso, le caratteristiche tecniche e le misure dei modelli illustrati nel presente catalogo. Le misure sono in cm. e in pollici.

*Porada reserves the right to change, at any time and without notice, the technical specifications, including modifications of sizes, of any product illustrated in this catalogue. The measures are in cm. and inches.*

## BEAM C

### ESSENZA - WOOD

noce canaletta - canaletta walnut  
 noce canaletta tinto moka - canaletta walnut moka stained  
 noce canaletta tinto wengé - canaletta walnut wengé stained  
 laccato opaco poro chiuso - matt lacquered closed pore

### CRISTALLO - GLASS

trasparente - clear

### METALLO - METAL

Cromo nero - black chromed  
 Ottone spazzolato - brushed brass

## TONDO

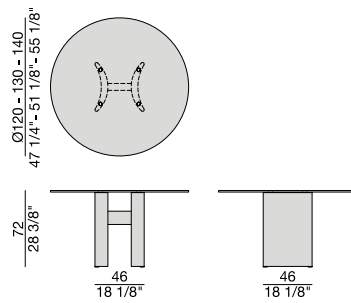

## BOTTE

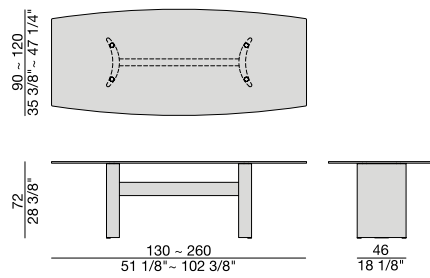

## RETTANGOLARE

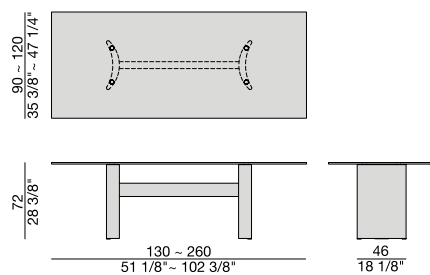

## BEAM L

### ESSENZA - WOOD

noce canaletta - canaletta walnut  
 noce canaletta tinto moka - canaletta walnut moka stained  
 noce canaletta tinto wengé - canaletta walnut wengé stained  
 laccato opaco poro chiuso - matt lacquered closed pore

### METALLO - METAL

Cromo nero - black chromed  
 Ottone spazzolato - brushed brass

## TONDO

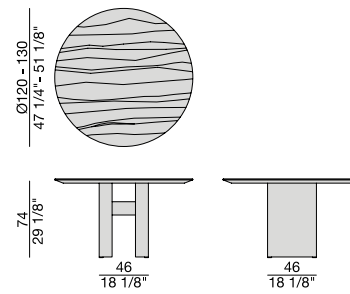

## BOTTE

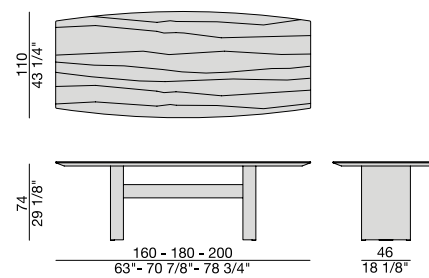

## BEAM M

### ESSENZA - WOOD

noce canaletta - canaletta walnut  
 noce canaletta tinto moka - canaletta walnut moka stained  
 noce canaletta tinto wengé - canaletta walnut wengé stained  
 laccato opaco poro chiuso - matt lacquered closed pore

### MARMO - MARBLE

nero Sahara Noir - black Sahara Noir  
 bianco Calacatta oro - white Calacatta gold  
 marrone Emperador Dark - brown Emperador Dark  
 grigio Carnico - grey Carnico

### METALLO - METAL

Cromo nero - black chromed  
 Ottone spazzolato - brushed brass

## TONDO

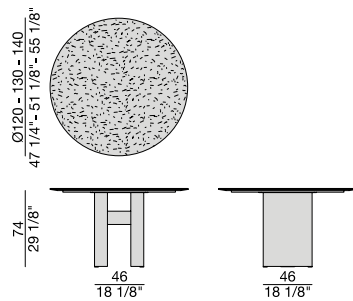

## BOTTE

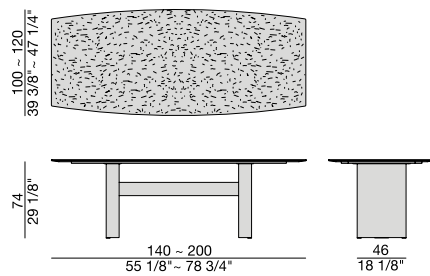

## BEAM ROCK

### ESSENZA - WOOD

noce canaletta - canaletta walnut  
 noce canaletta tinto moka - canaletta walnut moka stained  
 noce canaletta tinto wengé - canaletta walnut wengé stained  
 laccato opaco poro chiuso - matt lacquered closed pore

### ROCK - ROCK

calacatta opaco - matt calacatta  
 emperador opaco - matt emperador  
 oxide black opaco - matt oxide black

### METALLO - METAL

Cromo nero - black chromed  
 Ottone spazzolato - brushed brass

## TONDO

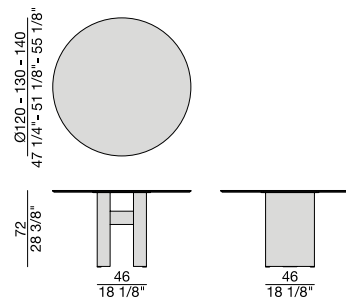

## BOTTE

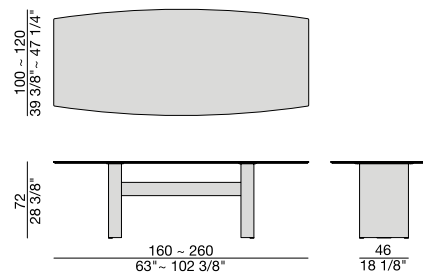

## RETTANGOLARE

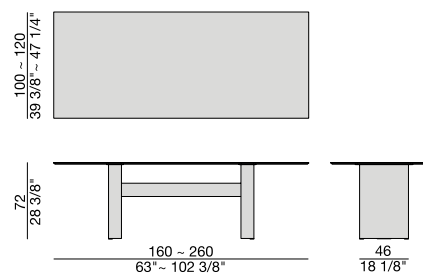

## BABY

### ESSENZA - WOOD

noce canaletta - canaletta walnut  
 noce canaletta tinto moka - canaletta walnut moka stained  
 noce canaletta tinto wengé - canaletta walnut wengé stained  
 laccato opaco poro chiuso - matt lacquered closed pore

### METALLO - METAL

cromato - chrome plated  
 nero opaco - matt black  
 ottone bronzato spazzolato - brushed bronzed brass

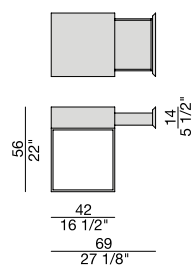

## BACKSTAGE

### ESSENZA - WOOD

noce canaletta - canaletta walnut  
 noce canaletta tinto moka - canaletta walnut moka stained  
 noce canaletta tinto wengé - canaletta walnut wengé stained  
 laccato opaco poro chiuso - matt lacquered closed pore

### METALLO - METAL

grigio peltro - grey pewter

### RIVESTIMENTO - COVER

cuoietto invecchiato

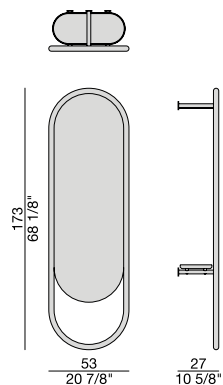

## CHIBA

### ESSENZA - WOOD

noce canaletta - canaletta walnut  
 noce canaletta tinto wengé - canaletta walnut wengé stained

### METALLO - METAL

nero opaco - matt black

## 80

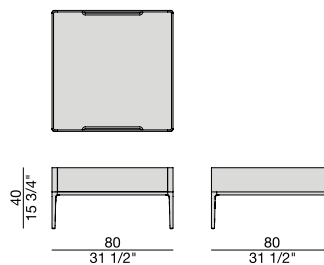

## 120

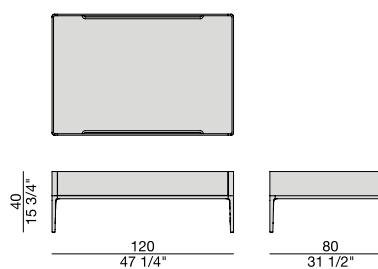

## COPINE BERGERE STEEL

METALLO - METAL  
 ottone bronzato spazzolato - brushed bronzed brass  
 nichel nero - black nickel

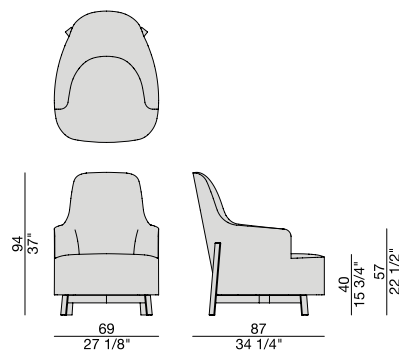

## COPINE BERGERE WOOD

ESSENZA - WOOD  
 noce canaletta - canaletta walnut  
 noce canaletta tinto moka - canaletta walnut moka stained  
 noce canaletta tinto wengé - canaletta walnut wengé stained  
 laccato opaco poro chiuso - matt lacquered closed pore

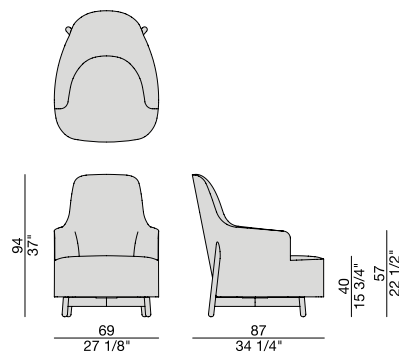

## COQUET

ESSENZA - WOOD  
 noce canaletta - canaletta walnut  
 noce canaletta tinto moka - canaletta walnut moka stained  
 noce canaletta tinto wengé - canaletta walnut wengé stained  
 laccato opaco poro chiuso - matt lacquered closed pore

METALLO - METAL  
 nichel nero - black nickel  
 ottone bronzato spazzolato - brushed bronzed brass

### 40

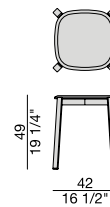

### 60

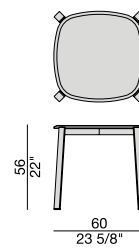

### 160X80

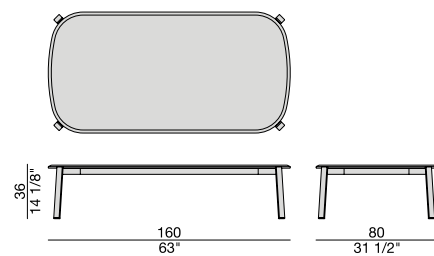

## CUCÙ

### ESSENZA - WOOD

noce canaletta - canaletta walnut  
 noce canaletta tinto moka - canaletta walnut moka stained  
 noce canaletta tinto wengé - canaletta walnut wengé stained  
 laccato opaco poro chiuso - matt lacquered closed pore

### METALLO - METAL

cromato - chrome plated  
 laccato nero - black lacquered  
 ottone bronzato spazzolato - brushed bronzed brass

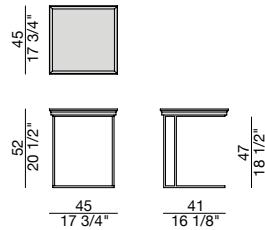

## EKERO RACK

### ESSENZA - WOOD

noce canaletta - canaletta walnut  
 noce canaletta tinto moka - canaletta walnut moka stained  
 noce canaletta tinto wengé - canaletta walnut wengé stained  
 laccato opaco poro chiuso - matt lacquered closed pore

### MARMO - MARBLE

bianco Carrara - white Carrara  
 grigio Carnico - grey Carnico

### METALLO - METAL

grigio peltro - grey pewter

### RIVESTIMENTO - COVER

cuoietto grigio scuro

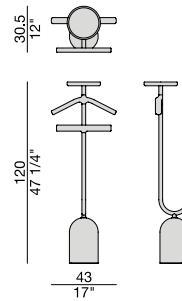

## EKERO MIRROR

### ESSENZA - WOOD

noce canaletta - canaletta walnut  
 noce canaletta tinto moka - canaletta walnut moka stained  
 noce canaletta tinto wengé - canaletta walnut wengé stained  
 laccato opaco poro chiuso - matt lacquered closed pore

### MARMO - MARBLE

bianco Carrara - white Carrara  
 grigio Carnico - grey Carnico

### METALLO - METAL

grigio peltro - grey pewter

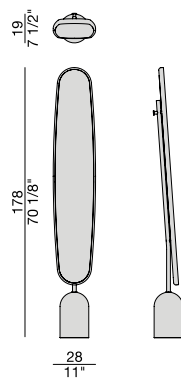

## EKERO KL ROUND 80

### ESSENZA - WOOD

noce canaletta - canaletta walnut  
 noce canaletta tinto moka - canaletta walnut moka stained  
 noce canaletta tinto wengé - canaletta walnut wengé stained  
 laccato opaco poro chiuso - matt lacquered closed pore

### MARMO - MARBLE

bianco Carrara - white Carrara  
 grigio Carnico - grey Carnico

### METALLO - METAL

nero opaco - matt black

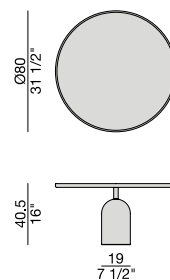

## GAMEN

### ESSENZA - WOOD

noce canaletta - canaletta walnut  
noce canaletta tinto moka - canaletta walnut moka stained  
noce canaletta tinto wengé - canaletta walnut wengé stained

### METALLO - METAL

grigio peltro - grey pewter

## COMP. 2 MODULI

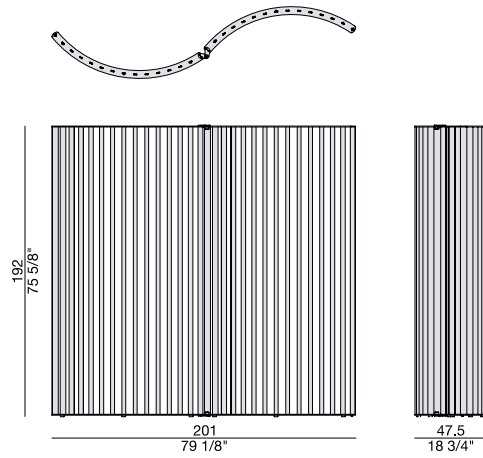

## COMP. 3 MODULI

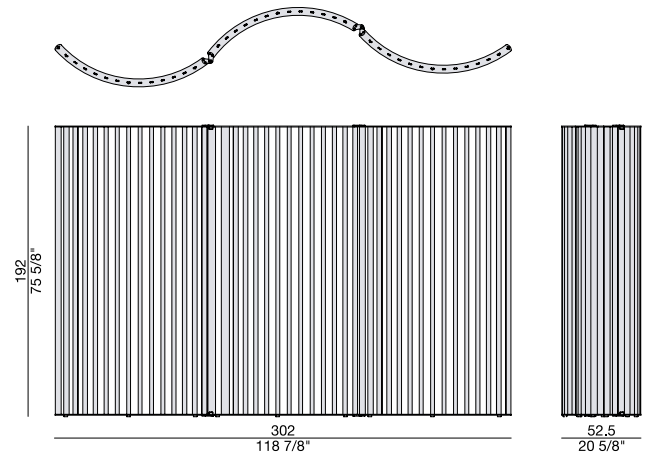

## XXL

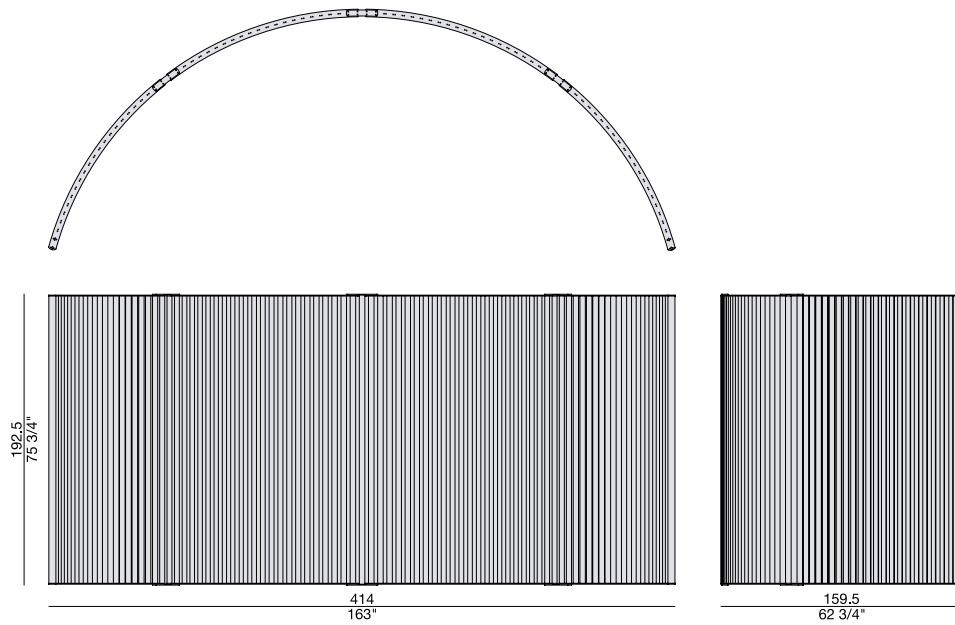

## GLADKO

ESSENZA - WOOD  
noce canaletta - canaletta walnut

RIVESTIMENTO ANTE - DOORS COVER  
noce canaletta - canaletta walnut  
cuoietto  
specchio fumè acidato - frosted smoked mirror  
specchio naturale - clear mirror

## WOODEN/CUOIETTO DOORS

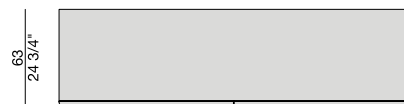

## MIRRORED DOORS

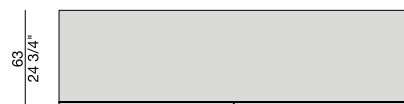

## INFINITY TAVOLO C

ESSENZA - WOOD  
noce canaletta - canaletta walnut  
noce canaletta tinto moka - canaletta walnut moka stained  
noce canaletta tinto wengé - canaletta walnut wengé stained  
laccato opaco poro chiuso - matt lacquered closed pore  
frassino naturale - natural ash  
frassino tinto moka - ash moka stained  
frassino tinto noce canaletta - ash canaletta walnut stained  
frassino tinto wengé - ash wengé stained  
frassino tinto canapa - ash canapa stained  
frassino tinto grigio - ash grey stained  
laccato opaco poro aperto - matt lacquered open pore

CRISTALLO - GLASS  
trasparente - clear

METALLO - METAL  
cromato - chrome plated  
grigio peltro - grey pewter  
cromo nero - black chromed  
ottone spazzolato - brushed brass  
nero opaco spazzolato - brushed matt black

## TONDO

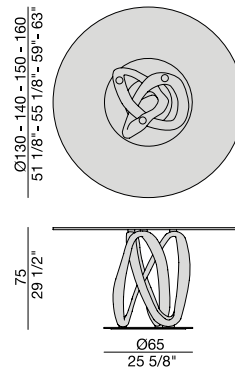

## OVALE 2 BASI

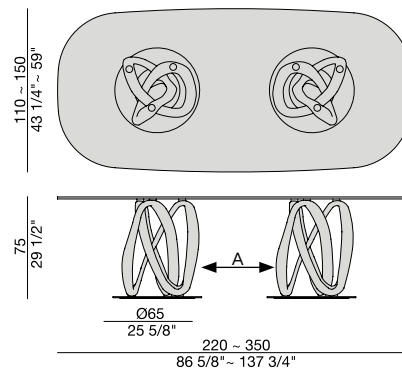



## INFINITY TAVOLINO

### ESSENZA - WOOD

noce canaletta - canaletta walnut  
 noce canaletta tinto moka - canaletta walnut moka stained  
 noce canaletta tinto wengé - canaletta walnut wengé stained  
 laccato opaco poro chiuso - matt lacquered closed pore  
 frassino naturale - natural ash  
 frassino tinto moka - ash moka stained  
 frassino tinto noce canaletta - ash canaletta walnut stained  
 frassino tinto wengé - ash wengé stained  
 frassino tinto canapa - ash canapa stained  
 frassino tinto grigio - ash grey stained  
 laccato opaco poro aperto - matt lacquered open pore

### CRISTALLO - GLASS

trasparente - clear

### METALLO - METAL

cromato - chrome plated  
 grigio peltro - grey pewter  
 cromo nero - black chromed  
 ottone spazzolato - brushed brass  
 nero opaco spazzolato - brushed matt black

## TONDO

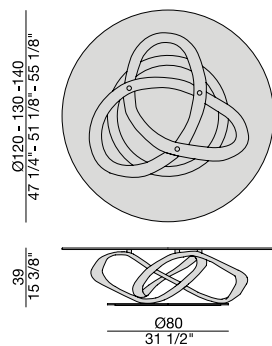

## OVALE

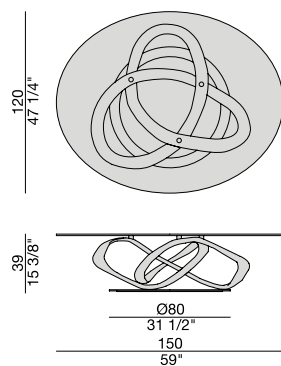

## IONIS

### ESSENZA - WOOD

noce canaletta - canaletta walnut  
 noce canaletta tinto moka - canaletta walnut moka stained  
 noce canaletta tinto wengé - canaletta walnut wengé stained  
 laccato opaco poro chiuso - matt lacquered closed pore

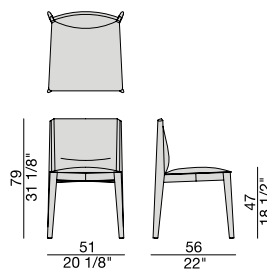

## IONIS CON BRACCIOLI

### ESSENZA - WOOD

noce canaletta - canaletta walnut  
 noce canaletta tinto moka - canaletta walnut moka stained  
 noce canaletta tinto wengé - canaletta walnut wengé stained  
 laccato opaco poro chiuso - matt lacquered closed pore

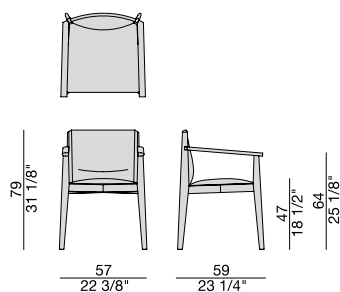

## KEPLER

### ESSENZA - WOOD

noce canaletta - canaletta walnut  
 noce canaletta tinto moka - canaletta walnut moka stained  
 noce canaletta tinto wengé - canaletta walnut wengé stained  
 laccato opaco poro chiuso - matt lacquered closed pore

### METALLO - METAL

ottone bronzato spazzolato - brushed bronzed brass

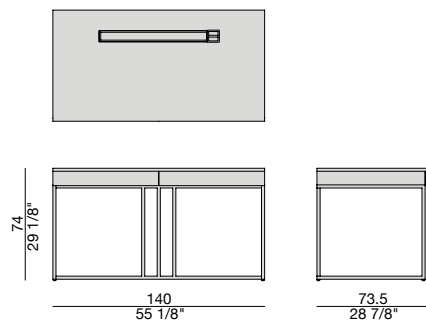

## KOSTER CONSOLE WOOD

### ESSENZA - WOOD

frassino naturale - natural ash  
 frassino tinto moka - ash moka stained  
 frassino tinto noce canaletta - ash canaletta walnut stained  
 frassino tinto wengé - ash wengé stained  
 frassino tinto canapa - ash canapa stained  
 frassino tinto grigio - ash grey stained  
 laccato opaco poro aperto - matt lacquered open pore

### METALLO - METAL

bronzoro

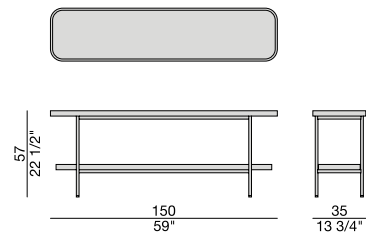

## KOSTER CONSOLE ROCK

### ESSENZA - WOOD

frassino naturale - natural ash  
 frassino tinto moka - ash moka stained  
 frassino tinto noce canaletta - ash canaletta walnut stained  
 frassino tinto wengé - ash wengé stained  
 frassino tinto canapa - ash canapa stained  
 frassino tinto grigio - ash grey stained  
 laccato opaco poro aperto - matt lacquered open pore

### METALLO - METAL

bronzoro

### ROCK

calacatta opaco - matt calacatta  
 emperador opaco - matt emperador  
 oxide black opaco - matt oxide black

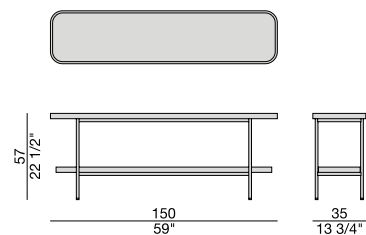

## LAGOM

### ESSENZA - WOOD

noce canaletta - canaletta walnut  
noce canaletta tinto moka - canaletta walnut moka stained  
noce canaletta tinto wengé - canaletta walnut wengé stained

### 54X54

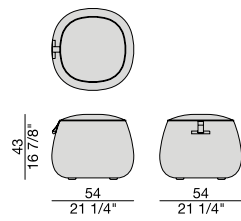

### 97X56

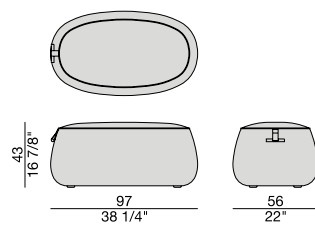

### 104X104

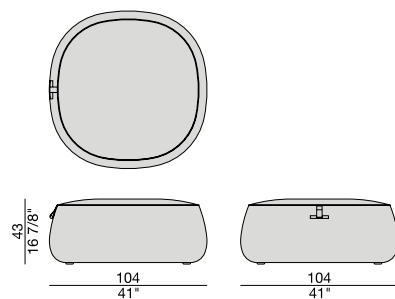

## LEAF

### ESSENZA - WOOD

noce canaletta - canaletta walnut  
ebano Macassar - Macassar ebony

### MARMO - MARBLE

grigio Carnico - grey Carnico

### 45

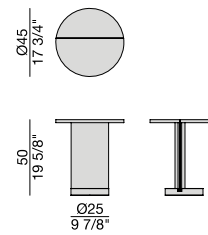

### 60

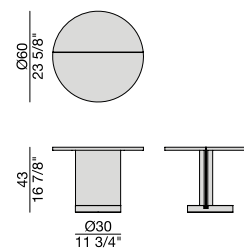

### 75

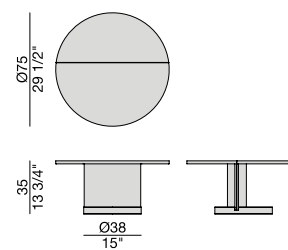

## NYAN

### ESSENZA - WOOD

noce canaletta - canaletta walnut  
noce canaletta tinto moka - canaletta walnut moka stained  
noce canaletta tinto wengé - canaletta walnut wengé stained

**180**

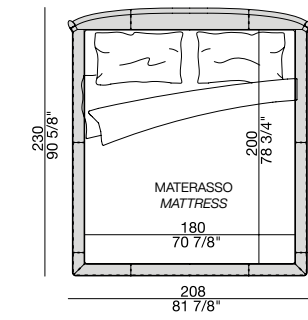

**200**

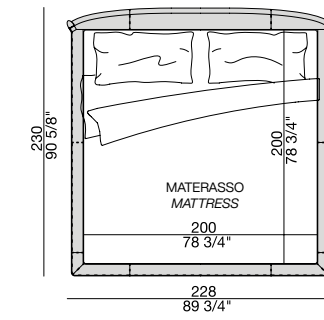

**AMERICAN KING SIZE**

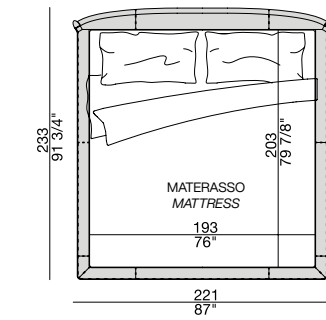

## NARA

### ESSENZA - WOOD

noce canaletta - canaletta walnut

noce canaletta tinto wengé - canaletta walnut wengé stained

### METALLO - METAL

nero opaco - matt black

**50**

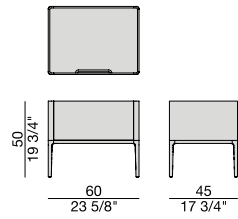

**3**

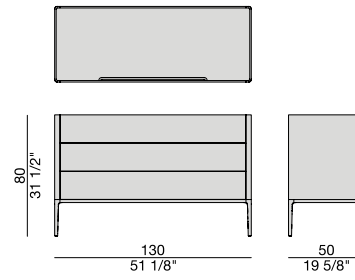

**60**

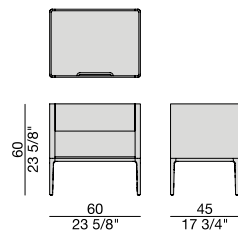

**4**

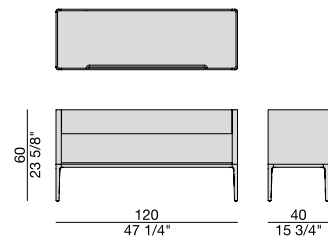

## MY SUITE WOODEN/CUOIETTO DOORS

ESSENZA - WOOD  
noce canaletta - canaletta walnut

RIVESTIMENTO - COVER  
cuoietto

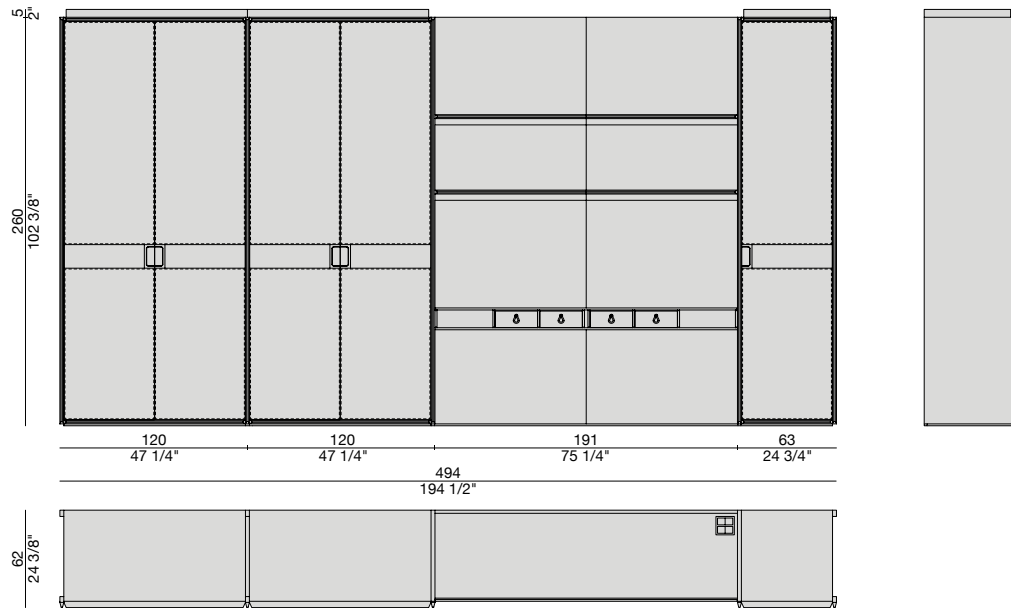

## MY SUITE GLASS DOORS

ESSENZA - WOOD  
noce canaletta - canaletta walnut

RIVESTIMENTO - COVER  
cuoietto

METALLO - METAL  
peltro - pewter

CRISTALLO - GLASS  
stopsol bronzo - stopsol bronze

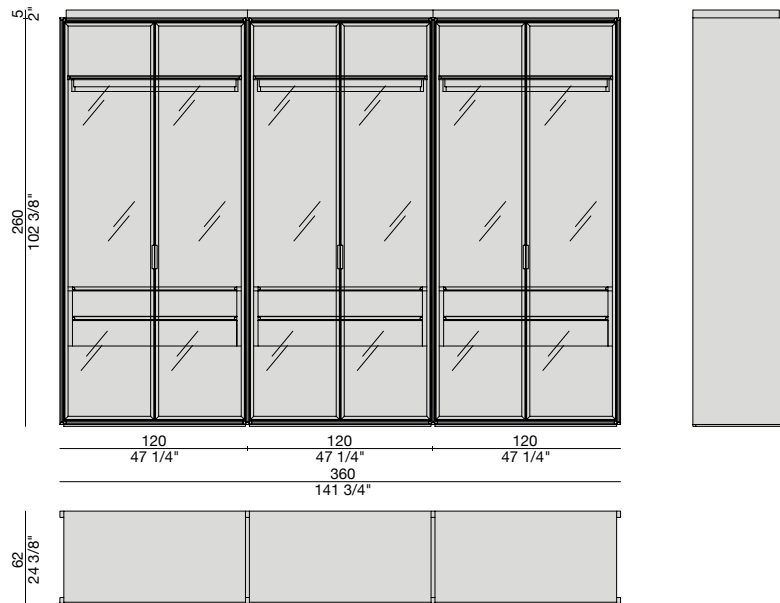

## PEBBLE

ESSENZA - WOOD  
noce canaletta - canaletta walnut

INTERNI  
frassino tinto grigio - ash grey stained

METALLO - METAL  
grigio peltro - grey pewter

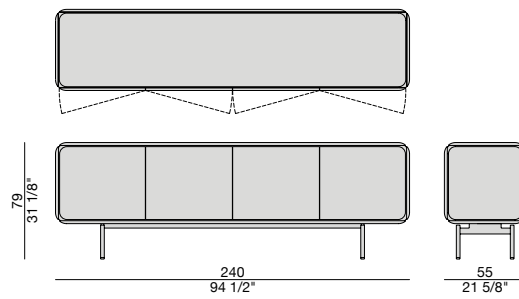

## SOFTBAY POLTRONA

ESSENZA - WOOD  
noce canaletta - canaletta walnut  
noce canaletta tinto moka - canaletta walnut moka stained  
noce canaletta tinto wengé - canaletta walnut wengé stained  
laccato opaco poro chiuso - matt lacquered closed pore

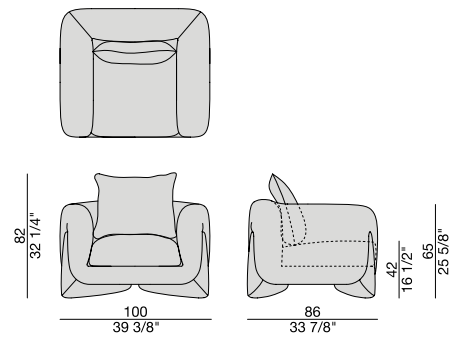

## PLISSÉ

ESSENZA - WOOD  
noce canaletta - canaletta walnut  
noce canaletta tinto moka - canaletta walnut moka stained  
noce canaletta tinto wengé - canaletta walnut wengé stained  
laccato opaco poro chiuso - matt lacquered closed pore

METALLO - METAL  
grigio peltro - grey pewter

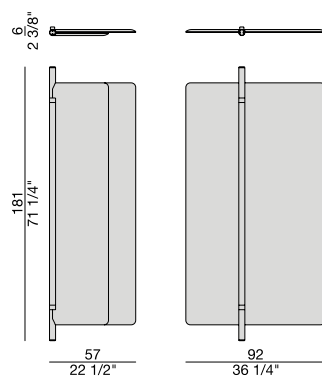

## SOFTBAY BED

### ESSENZA - WOOD

noce canaletta - canaletta walnut  
noce canaletta tinto moka - canaletta walnut moka stained  
noce canaletta tinto wengé - canaletta walnut wengé stained  
laccato opaco poro chiuso - matt lacquered closed pore

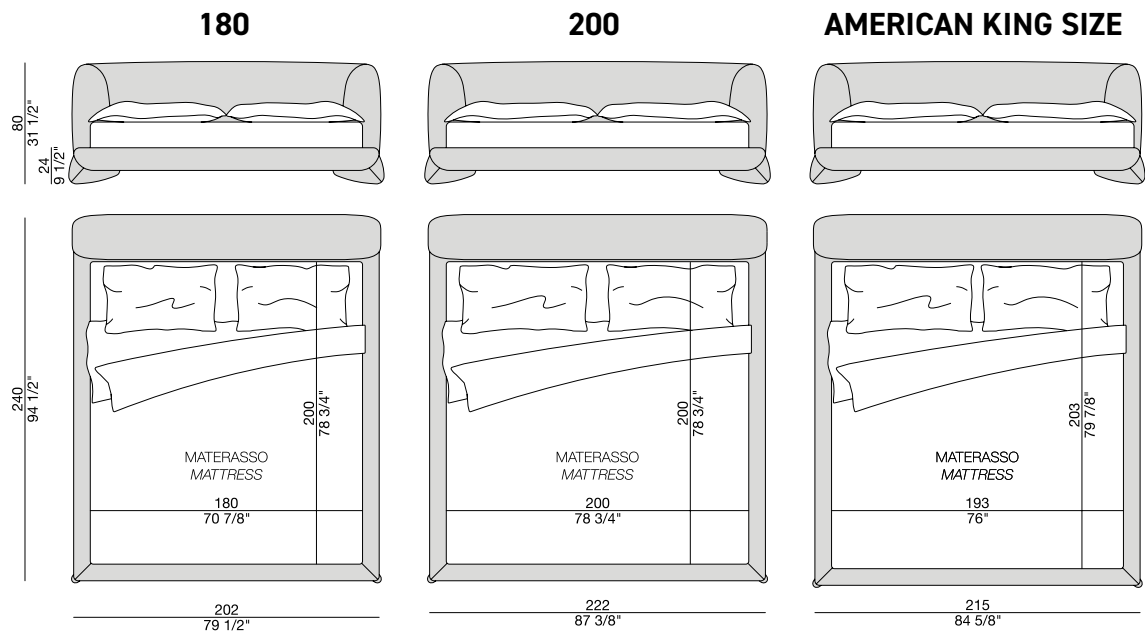



## STYLO 140

### ESSENZA - WOOD

noce canaletta - canaletta walnut  
noce canaletta tinto moka - canaletta walnut moka stained  
noce canaletta tinto wengé - canaletta walnut wengé stained  
laccato opaco poro chiuso - matt lacquered closed pore

### CRISTALLO - GLASS

trasparente - clear

### METALLO - METAL

ottone bronzato spazzolato - brushed bronzed brass

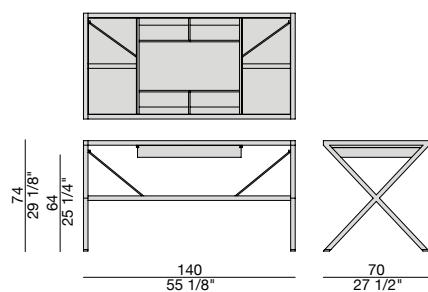

## STYLO WOOD

### ESSENZA - WOOD

noce canaletta - canaletta walnut  
noce canaletta tinto moka - canaletta walnut moka stained  
noce canaletta tinto wengé - canaletta walnut wengé stained  
laccato opaco poro chiuso - matt lacquered closed pore

### METALLO - METAL

ottone bronzato spazzolato - brushed bronzed brass

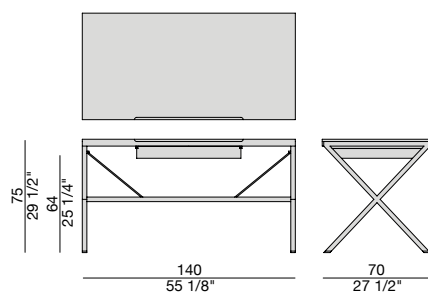



# **MATERIALI**

## ***MATERIALS***

Per motivi tecnici non è possibile garantire la stessa tonalità di colore tra una fornitura e l'altra. I colori riprodotti in queste pagine sono indicativi.

*Due to technical reasons it is not possible to guarantee the same tone in different deliveries. The colours shown in the following pages could not match precisely the current colours collection.*

**ESSENZA**  
WOOD



**FRASSINO NATURALE**  
NATURAL ASH



**FRASSINO TINTO CANAPA**  
ASH CANAPA STAINED



**NOCE CANALETTA**  
CANALETTA WALNUT



**FRASSINO TINTO NOCE CANALETTA**  
ASH CANALETTA WALNUT STAINED



**FRASSINO TINTO GRIGIO**  
ASH GREY STAINED



**NOCE CANALETTA TINTO MOKA**  
CANALETTA WALNUT MOKA STAINED

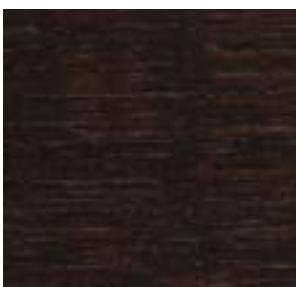

**FRASSINO TINTO MOKA**  
ASH MOKA STAINED



**FRASSINO TINTO WENGÈ**  
ASH WENGÈ STAINED



**NOCE CANALETTA TINTO WENGÈ**  
CANALETTA WALNUT WENGÈ STAINED



**ROVERE SPESSART**  
OAK SPESSART

**LACCATO OPACO  
PORO APERTO**  
MATT LACQUERED  
OPEN PORE

**LACCATO OPACO  
PORO CHIUSO**  
MATT LACQUERED  
CLOSED PORE

**LACCATO BRILLANTE**  
SHINY LACQUERED

**FOGLIA**  
LEAF

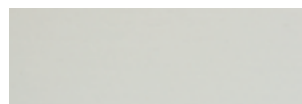

**BIANCO** RAL 9016  
WHITE



**BIANCO** RAL 9016  
WHITE



**BIANCO** RAL 9016  
WHITE



**ARGENTO**  
SILVER



**NERO** RAL 9005  
BLACK



**NERO** RAL 9005  
BLACK



**NERO** RAL 9005  
BLACK



**ORO**  
GOLDEN



**CIOCCOLATO** RAL 8019  
CHOCOLATE



**CIOCCOLATO** RAL 8019  
CHOCOLATE



**CIOCCOLATO** RAL 8019  
CHOCOLATE



**IRON** RAL 7011  
IRON



**IRON** RAL 7011  
IRON



**IRON** RAL 7011  
IRON

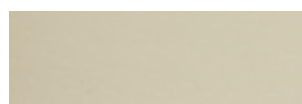

**AVORIO** RAL 1013  
IVORY



**AVORIO** RAL 1013  
IVORY



**AVORIO** RAL 1013  
IVORY



**ARGILLA** RAL 7006  
ARGILLA



**ARGILLA** RAL 7006  
ARGILLA



**ARGILLA** RAL 7006  
ARGILLA



**GRANATA** NCS S 4050 Y90R  
GRANATA



**GRANATA** NCS S 4050 Y90R  
GRANATA



**GRANATA** NCS S 4050 Y90R  
GRANATA



**PISTACCHIO** PANTONE 5825  
PISTACCHIO



**PISTACCHIO** PANTONE 5825  
PISTACCHIO



**PISTACCHIO** PANTONE 5825  
PISTACCHIO



**AVIO** PANTONE 5415  
AVIO



**AVIO** PANTONE 5415  
AVIO



**AVIO** PANTONE 5415  
AVIO

**METALLO**  
METAL



**ANTRACITE SPAZZOLATO**  
BRUSHED ANTHRACITE



**GRIGIO PELTRO**  
GREY PEWTER



**BIANCO OPACO**  
WHITE MATT

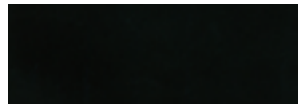

**NERO OPACO**  
MATT BLACK

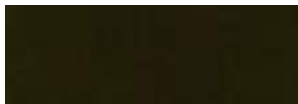

**BRONZORO**

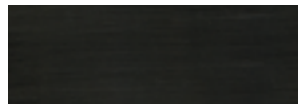

**NERO OPACO SPAZZOLATO**  
BRUSHED MATT BLACK



**CROMATO**  
CHROME PLATED



**OTTONE BRONZATO SPAZZOLATO**  
BRUSHED BRONZE BRASS



**CROMO NERO**  
BLACK CHROMED



**OTTONE SPAZZOLATO**  
BRUSHED BRASS



**NICHEL NERO**  
BLACK NICKEL

**SPECCHIO**  
MIRROR



**NATURALE**  
CLEAR



**FUMÈ**  
SMOKED

**CRISTALLO**  
GLASS

**CRISTALLO ACIDATO**  
**RETROVERNICIATO**  
BACK-PAINTED  
FROSTED GLASS

**VETRO FUSO**  
CAST GLASS



**TRASPARENTE**  
CLEAR

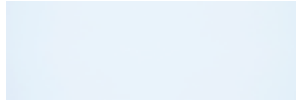

**EXTRACHIARO LACCATO BIANCO**  
EXTRALIGHT WHITE LACQUERED



**NATURALE**  
CLEAR



**FUMÈ**  
SMOKED



**LACCATO NERO**  
BLACK LACQUERED



**FUMÈ**  
SMOKED

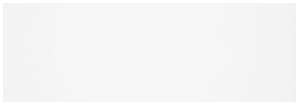

**LACCATO BIANCO**  
WHITE LACQUERED



**EXTRACHIARO LACCATO IRON**  
EXTRALIGHT IRON LACQUERED



**RUGGINE**  
RUGGINE



**LACCATO NERO**  
BLACK LACQUERED



**EXTRACHIARO LACCATO ARGILLA**  
EXTRALIGHT ARGILLA LACQUERED



**BLU**  
BLUE



**LACCATO IRON**  
IRON LACQUERED



**EXTRACHIARO LACCATO GRANATA**  
EXTRALIGHT GRANATA LACQUERED



**VERDE**  
GREEN



**LACCATO ARGILLA**  
ARGILLA LACQUERED



**LACCATO GRANATA**  
GRANATA LACQUERED



**EXTRACHIARO TRASPARENTE ROSA**  
CLEAR EXTRALIGHT PINK



**EXTRACHIARO TRASPARENTE GRANATA**  
CLEAR EXTRALIGHT GRANATA

**MARMO BIANCO  
CALACATTA ORO**  
MARBLE WHITE  
CALACATTA GOLD



**VENATURA ECCESSIVA**  
HIGHLY MARKED VEIN



**VENATURA SCARSA**  
LOW MARKED VEIN



**VENATURA ROSSA**  
RED SHADED VEIN



**VENATURA VERDE**  
GREEN SHADED VEIN



**VENATURA GRIGIA**  
GREY VEIN



**PRESENZA DI PIETRE GRIGIE**  
PRESENCE OF GREY STONES



**ALTRI ESEMPI**  
OTHER EXAMPLES



**ALTRI ESEMPI**  
OTHER EXAMPLES

**MARMO MARRONE  
EMPERADOR DARK**  
MARBLE BROWN  
EMPERADOR DARK



**VENATURA ECCESSIVA**  
HIGHLY MARKED VEIN



**VENATURA SCARSA**  
LOW MARKED VEIN

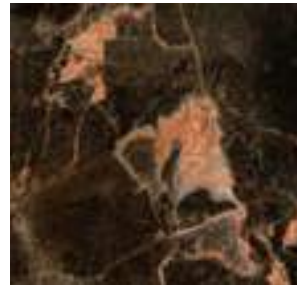

**TRACCE DI ARGILLA ROSSA**  
TRACES OF RED CLAY



**CONCETRAZIONE DI SASSOLINI**  
HIGH CONCENTRATION OF SMALL  
STONES

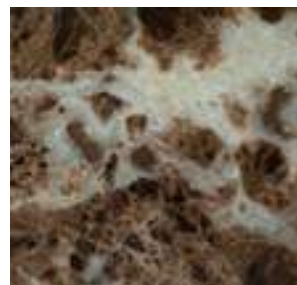

**PRESENZA DI PIETRE GRIGIE**  
PRESENCE OF GREY STONES



**ALTRI ESEMPI**  
OTHER EXAMPLES



**ALTRI ESEMPI**  
OTHER EXAMPLES



**ALTRI ESEMPI**  
OTHER EXAMPLES

Le immagini riportate hanno scopo puramente indicativo; i colori e le venature del materiale possono variare.  
The images shown above are for reference only; the colours and the veins of the material may vary.



**MARMO NERO**  
**SAHARA NOIR**  
MARBLE BLACK  
SAHARA NOIR



**VENATURA ECCESSIVA**  
HIGHLY MARKED VEIN



**VENATURA SCARSA**  
LOW MARKED VEIN



**ESEMPIO DI VENATURA**  
VEIN DETAIL



**ESEMPIO DI VENATURA**  
VEIN DETAIL



**ALTRI ESEMPI**  
OTHER EXAMPLES



**ALTRI ESEMPI**  
OTHER EXAMPLES



**ALTRI ESEMPI**  
OTHER EXAMPLES



**ALTRI ESEMPI**  
OTHER EXAMPLES

**MARMO GRIGIO**  
**CARNICO**  
MARBLE GREY  
CARNICO



**VENATURA ECCESSIVA**  
HIGHLY MARKED VEIN



**VENATURA ECCESSIVA**  
HIGHLY MARKED VEIN

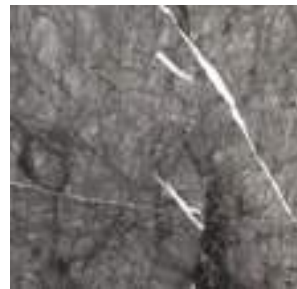

**VENATURA SCARSA**  
LOW MARKED VEIN



**VENATURA SCARSA**  
LOW MARKED VEIN

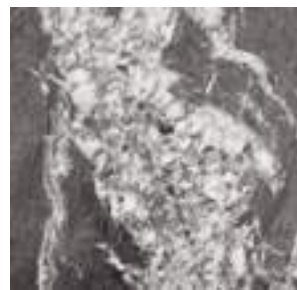

**ALTRI ESEMPI**  
OTHER EXAMPLES



**ALTRI ESEMPI**  
OTHER EXAMPLES



**ALTRI ESEMPI**  
OTHER EXAMPLES



**ALTRI ESEMPI**  
OTHER EXAMPLES

porada XXI

Porcellana laminata ottenuta per macinazione ad umido di materie prime argillose, rocce granitiche e metamorfiche, a componente feldspatica e pigmenti ceramici. Compattata da speciale formatura in compatter e sinterizzazione a 1200°C, con cottura a gas. Rock resiste al contatto prolungato con le principali macchie ostinate presenti in cucina quali vino, caffè, olio d'oliva, limone, senza alterazioni permanenti di colore o brillantezza.

*Laminated porcelain obtained by wet-grinding clay, granite and metamorphic rock raw materials together with a feldspar component and ceramic pigments. Specially shaped in a compactor and sintered at 1200°C, with gas firing. Rock is not affected by prolonged contact with products commonly found in the kitchen that can cause staining, such as wine, coffee, olive oil or lemon juice, and its colour or shine will not be affected permanently.*

## ROCK OXIDE BLACK OPACO ROCK MATT OXIDE BLACK



Ripresa grafica della lastra intera (324 x 162 cm.) da noi utilizzata.  
Image of the whole sheet (324 x 162 cm.) we use.

**ROCK CALACATTA OPACO**  
ROCK MATT CALACATTA



**Riprese grafiche delle lastre intere (324 x 162 cm.) da noi utilizzate.**  
**Non è possibile la selezione della lastra da parte del cliente.**  
Image of the whole sheet (324 x 162 cm.) we use.  
Customer can not select the sheet to be used.

porada XXI

Porcellana laminata ottenuta per macinazione ad umido di materie prime argillose, rocce granitiche e metamorfiche, a componente feldspatica e pigmenti ceramici. Compattata da speciale formatura in compatter e sinterizzazione a 1200°C, con cottura a gas. Rock resiste al contatto prolungato con le principali macchie ostinate presenti in cucina quali vino, caffè, olio d'oliva, limone, senza alterazioni permanenti di colore o brillantezza.

*Laminated porcelain obtained by wet-grinding clay, granite and metamorphic rock raw materials together with a feldspar component and ceramic pigments. Specially shaped in a compactor and sintered at 1200°C, with gas firing. Rock is not affected by prolonged contact with products commonly found in the kitchen that can cause staining, such as wine, coffee, olive oil or lemon juice, and its colour or shine will not be affected permanently.*

## ROCK EMPERADOR OPACO ROCK MATT EMPERADOR



**Riprese grafiche delle lastre intere (324 x 162 cm.) da noi utilizzate.**

**Non è possibile la selezione della lastra da parte del cliente.**

Image of the whole sheet (324 x 162 cm.) we use.

Customer can not select the sheet to be used.



## CUOIO

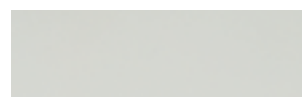

BIANCO



NERO



FOCA



GRIGIO SCURO



CORDA



SABBIA



NATURALE



INVECCHIATO



TESTA DI MORO



ROSSO BULGARO

## CUOINETTO

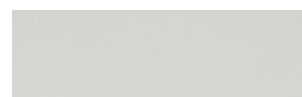

BIANCO



NERO



FOCA



GRIGIO SCURO



CORDA



SABBIA



NATURALE



INVECCHIATO



TESTA DI MORO



ROSSO BULGARO

## NABUK



2136



2115

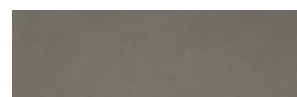

2107



2118



2103



2117



2114



2133



2130



2108

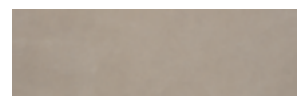

2101



2116

## cat. LUX

**pellame**

raw material

**concia**

tannage

**tintura**

dyeing

**rifinitone**

finish

**bovino europeo**

european bovine leather

**al cromo**

chrome tanning

**all'anilina**

aniline dyed

**all'anilina**

aniline

## PELLE PLUS



## cat. PLUS

|                                  |  |
|----------------------------------|--|
| <b>pellame</b><br>raw material   | <b>bovino europeo</b><br>european cattle skins |
| <b>concia</b><br>tannage         | <b>al cromo</b><br>chrome tanning              |
| <b>tintura</b><br>dyeing         | <b>all'anilina</b><br>aniline dyed             |
| <b>tipologia</b><br>leather type | <b>pieno fiore</b><br>full grain               |

## PELLE EXTRA



## cat. EXTRA

|                                  |   |
|----------------------------------|---|
| <b>pellame</b><br>raw material   | <b>bovino europeo</b><br>european bovine hide |
| <b>concia</b><br>tannage         | <b>al cromo</b><br>chrome tanning             |
| <b>tintura</b><br>dyeing         | <b>all'anilina</b><br>aniline dyed            |
| <b>tipologia</b><br>leather type | <b>fiore corretto</b><br>top grain            |



## PELLE



### cat. PELLE

|                  |                       |
|------------------|-----------------------|
| <b>pellame</b>   | <b>bovino europeo</b> |
| raw material     | european bovine hide  |
| <b>concia</b>    | <b>al cromo</b>       |
| tannage          | chrome tanning        |
| <b>tintura</b>   | <b>all'anilina</b>    |
| dyeing           | aniline dyed          |
| <b>tipologia</b> | <b>fiore corretto</b> |
| leather type     | top grain             |

## BOUCLAGE



## MILORD



### cat. B

34%VI - 33%PC - 17%WO - 8%PL -  
4%LI - 4%CO



### cat. B

63% PL - 37% CO



# MOTLEY



217



317



517



817



211



311



511



811



224



324



524



824



200



300



500



800

## cat. B

34% CO - 48% LI - 10% PC - 8% AF

34% CO - 48% LI - 10% PC - 8% AF

34% CO - 48% LI - 10% PC - 8% AF

75% CO - 14% PC - 11% AF



**RABAT**

**L1454**

**L1571**

**11524**

**12823**



L1454/10



L1571/99



11524/17



11524/04

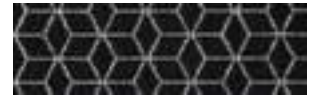

12823/37



L1454/05



L1571/93



11524/18



11524/14

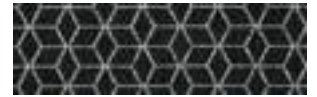

12823/20



L1454/02



L1571/50



11524/5



11524/16



12823/40



L1454/06



L1571/59



11524/3



11524/06



12823/44



11524/24



11524/10



12823/36



11524/02



11524/09

**cat. B**

64 % VI - 15% PL -  
11% CO - 10% LI

30% LI - 39% CO - 23% VI -  
4% PL - 4% PA

44% CO - 22% PL - 21% PC - 13% VI

48% VI - 32% PC - 20% PL



## ARMAM



### cat. C

39% VI - 35% CO - 16% PL - 10% LI

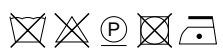

## FLAX



### cat. C

54% JU - 46% LI



**IKAT**

**L1575**

**13696**



L1575/01



13696/08



L1575/10



13696/57

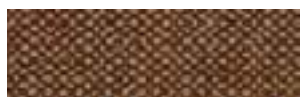

L1575/12



13696/27



L1575/14



13696/24



L1575/07



13696/09



L1575/04



13696/54



L1575/05



13696/12



L1575/06



13696/52

**LOOM**



L1534/01



L1534/02



L1534/03



L1534/08



L1534/06



L1534/09



L1534/10



L1534/11



L1534/13



L1534/12

**cat. C**

51% VI - 23% CO -  
16% PL - 10% LI

75% PL - 16% CO - 9% PC

**cat. C**

52% VI - 25% CO - 12% LI - 11% PL



**MADRAS**

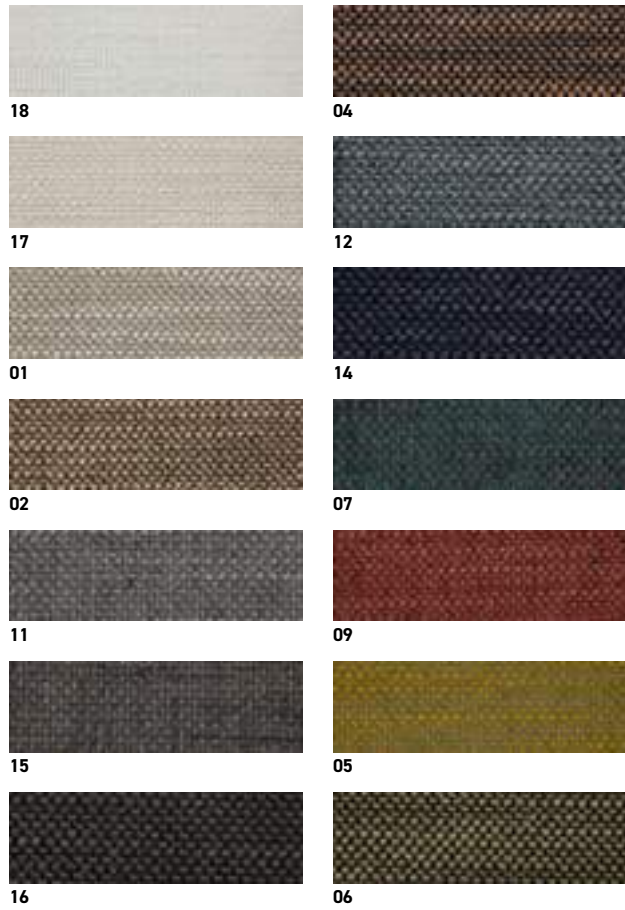

**cat. C**

30% CO - 29% PC - 26% PL - 15% VI

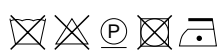

**MOLESKIN**



**cat. C**

100% PL



## MORAN



### cat. C

50% VI - 30% CO - 20% PL

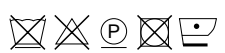

## PATCH

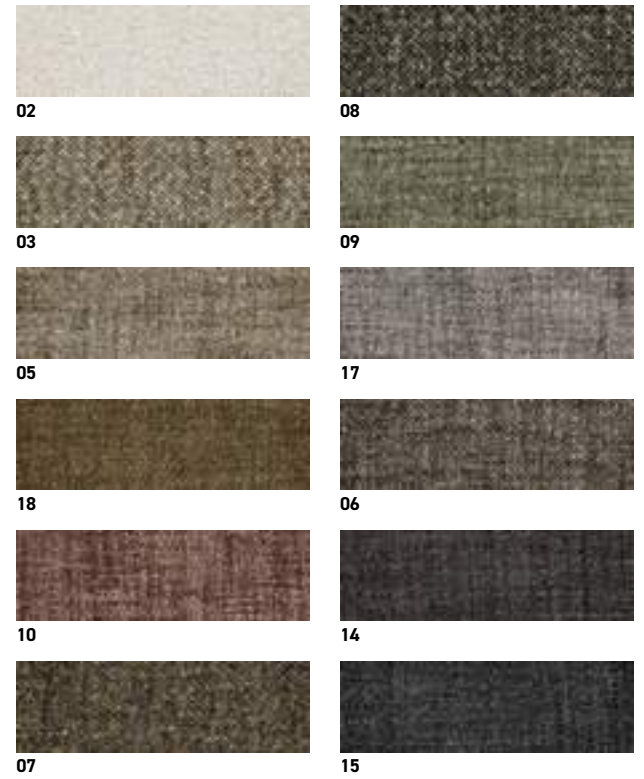

### cat. C

47% VI - 26% CO - 10% LI - 8% PL - 6% PA - 3% PC





# SERGE



001



055



003



036



004



043



009



044



010



146



089



091



028



155



065



159



066



160



020



162

## cat. C

80% WO - 20% PA

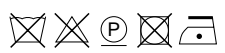

VELVET



cat. C

100% CO

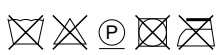

**ECOPELLE**



**cat. D**

63% PU - 37% CO

**RANGE**



**cat. D**

56% CO - 24% VI - 20% LI



## TRESS

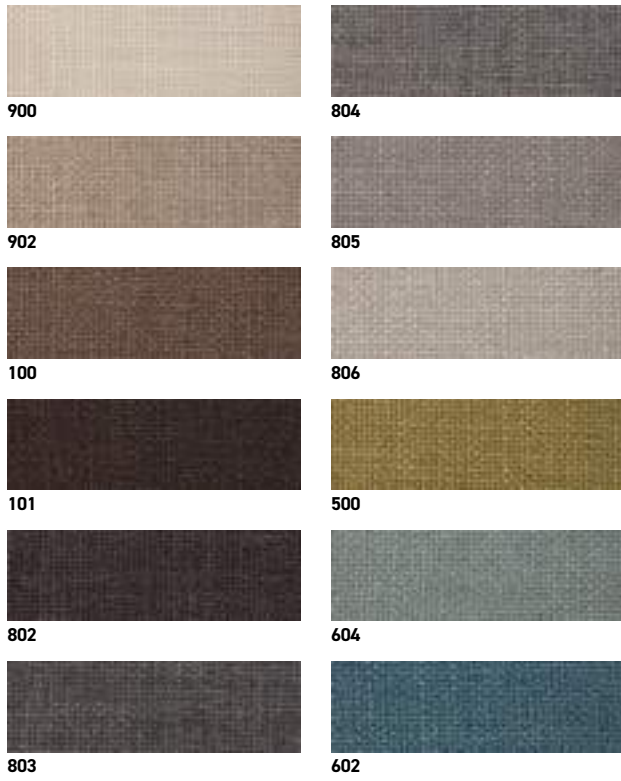

## COTONE

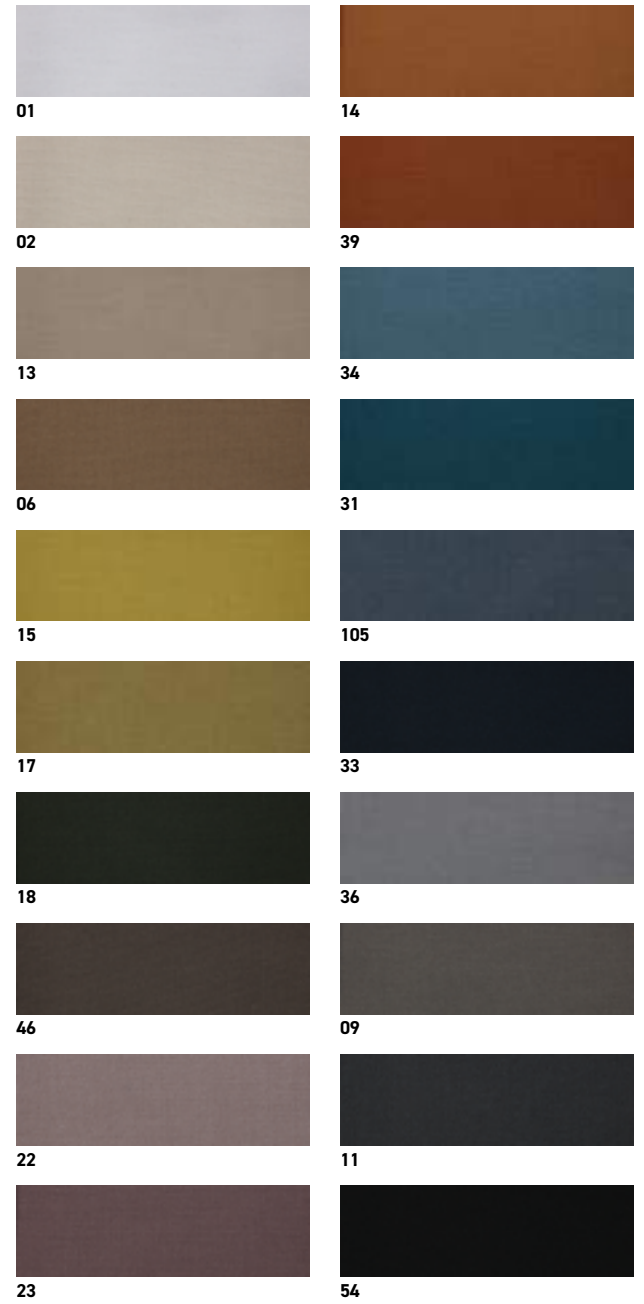

### cat. D

84% PES - 16% AC

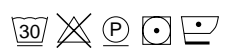

### cat. E

100% CO



## DORIAN



## ZENITH



### cat. E

40% VI - 20% PL - 20% LI - 20% CO

### cat. PROFILO/PIPING

60% CO - 40% AC

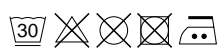

**RUGS COLLECTION  
EDEN**



**010 WHITE**



**901 GREY**



**590 BLUE**



**011 TAUPE**



**020 BROWN**



**023 RED**



**203 SAND**



**235 CARAMEL**



**623 GREEN**

100% ECONYL®

**RUGS COLLECTION  
WAVE - A**

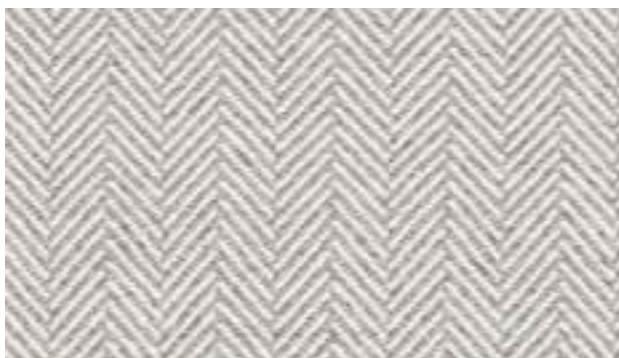

**WHITE/GREY**

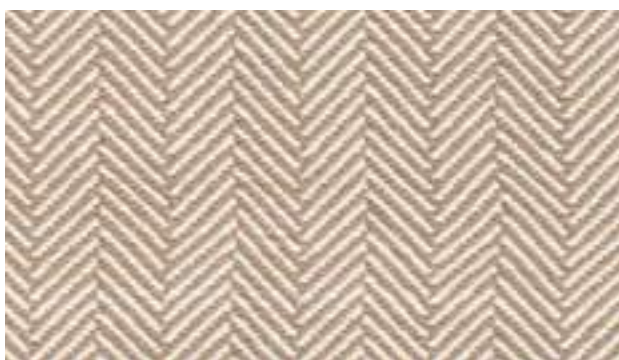

**WHITE/SAND**

**100% LANA DELLA NUOVA ZELANDA**  
100% NEW ZELAND WOOL

**RUGS COLLECTION  
WAVE - S**



**WHITE/GREY**



**WHITE/SAND**

**100% LANA DELLA NUOVA ZELANDA**  
100% NEW ZELAND WOOL





**porada**

GRAPHIC DESIGNER:  
MARIELLA ARNABOLDI  
PORADA LAB

—  
PHOTOGRAPHER:  
MATTEO IMBRIANI

—  
COORDINATION,  
CONCEPT AND STYLING:  
PAOLA CITTERIO

—  
PRINTING:  
CHINCHIO  
INDUSTRIA GRAFICA SRL

LONDON SHOWROOM:  
FIRST FLOOR,  
SOUTH DOME  
DESIGN CENTRE  
CHELSEA HARBOUR  
LONDON - SW10 0XE  
PH: 020 3155 3065  
ENQUIRIESUK@PORADA.IT

MILANO SHOWROOM:  
20121 MILANO  
(MI) ITALIA  
VIA BORGOSPESSO, 18  
TEL. +39 02 49700 896  
MILANO@PORADA.IT

22060 CABIATE  
(COMO) ITALIA  
VIA B. BUOZZI, 2  
TEL. +39 031 766215  
INFO@PORADA.IT

WWW.PORADA.IT



LONDON SHOWROOM:  
FIRST FLOOR,  
SOUTH DOME  
DESIGN CENTRE  
CHELSEA HARBOUR  
LONDON - SW10 0XE  
PH: 020 3155 3065  
ENQUIRIESUK@PORADA.IT

MILANO SHOWROOM:  
20121 MILANO  
(MI) ITALIA  
VIA BORGOSPESSO, 18  
TEL. +39 02 49700 896  
MILANO@PORADA.IT

22060 CABIATE  
(COMO) ITALIA  
VIA B. BUOZZI, 2  
TEL. +39 031 766215  
INFO@PORADA.IT

[WWW.PORADA.IT](http://WWW.PORADA.IT)